

TPS7A52-Q1 2-A, High-Accuracy, Automotive-Grade, Low-Noise, LDO Voltage Regulator

1 Features

- Qualified for Automotive Applications
- AEC-Q100 Qualified for Automotive Applications:
 - Temperature Grade 1: $-40^{\circ}\text{C} \leq T_A \leq +125^{\circ}\text{C}$
 - HBM ESD Classification Level 2
 - CDM ESD Classification Level C4A
- Extended Junction Temperature (T_J) Range: -40°C to $+150^{\circ}\text{C}$
- Input Voltage Range:
 - Without BIAS: 1.4 V to 6.5 V
 - With BIAS: 1.1 V to 6.5 V
- Adjustable Output Voltage Range: 0.8 V to 5.2 V
- Low Dropout: 115 mV (max) at 2 A With BIAS
- Output Voltage Noise: $4.4 \mu\text{V}_{\text{RMS}}$
- 1% (max) Accuracy Over Line, Load, and Temperature With BIAS
- Power-Supply Ripple Rejection:
 - 40 dB at 500 kHz
- Adjustable Soft-Start Inrush Control
- Open-Drain, Power-Good (PG) Output
- Packages:
 - 3.5-mm x 3.5-mm, 20-Pin VQFN
 - 4-mm x 4-mm, 20-Pin VQFN With Wettable Flanks and High CTE (12 ppm/ $^{\circ}\text{C}$) Mold Compound

2 Applications

- Telematic Control Units
- Infotainment and Clusters
- High-Speed Interfaces (PLL and VCO)

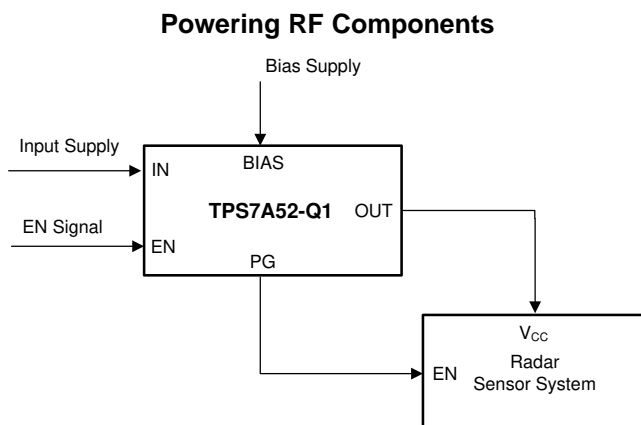

3 Description

The TPS7A52-Q1 device is a low-noise ($4.4 \mu\text{V}_{\text{RMS}}$), low-dropout linear regulator (LDO) capable of sourcing 2 A with only 115 mV of maximum dropout. The device output voltage is adjustable from 0.8 V to 5.2 V using an external resistor divider.

The combination of low-noise ($4.4 \mu\text{V}_{\text{RMS}}$), high-PSRR, and high output current capability makes the TPS7A52-Q1 ideal to power noise-sensitive components such as those found in radar power and infotainment applications. The high performance of this device limits power-supply-generated phase noise and clock jitter, making this device ideal for powering RF amplifiers, radar sensors, and chipsets. Specifically, RF amplifiers benefit from the high-performance and 5.0-V output capability of the device.

For digital loads [such as application-specific integrated circuits (ASICs), field-programmable gate arrays (FPGAs), and digital signal processors (DSPs)] requiring low-input voltage, low-output (LILO) voltage operation, the exceptional accuracy (1% over load and temperature), remote sensing, excellent transient performance, and soft-start capabilities of the TPS7A52-Q1 provides optimal system performance.

The versatility of the TPS7A52-Q1 makes the device a component of choice for many demanding applications.

Device Information⁽¹⁾

PART NUMBER	PACKAGE	BODY SIZE (NOM)
TPS7A52-Q1	VQFN (20)	3.50 mm x 3.50 mm
	Wettable flank VQFN (20)	4.00 mm x 4.00 mm

(1) For all available packages, see the package option addendum at the end of the datasheet.

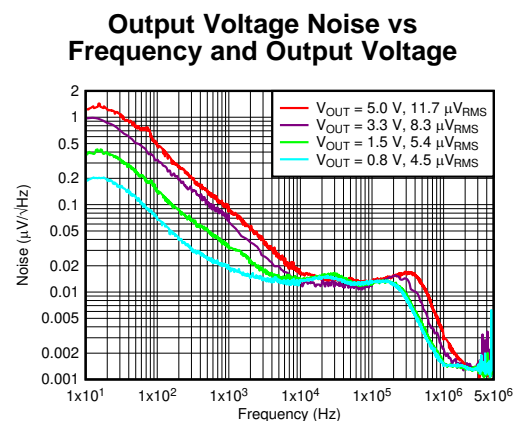

Table of Contents

1 Features	1	8 Application and Implementation	20
2 Applications	1	8.1 Application Information.....	20
3 Description	1	8.2 Typical Application	28
4 Revision History	2	9 Power Supply Recommendations	29
5 Pin Configuration and Functions	3	10 Layout	30
6 Specifications	4	10.1 Layout Guidelines	30
6.1 Absolute Maximum Ratings	4	10.2 Layout Example	31
6.2 ESD Ratings.....	4	11 Device and Documentation Support	32
6.3 Recommended Operating Conditions.....	4	11.1 Device Support.....	32
6.4 Thermal Information	5	11.2 Documentation Support	32
6.5 Electrical Characteristics.....	5	11.3 Receiving Notification of Documentation Updates	33
6.6 Typical Characteristics	7	11.4 Support Resources	33
7 Detailed Description	14	11.5 Trademarks	33
7.1 Overview	14	11.6 Electrostatic Discharge Caution.....	33
7.2 Functional Block Diagram	14	11.7 Glossary	33
7.3 Feature Description.....	15	12 Mechanical, Packaging, and Orderable	33
7.4 Device Functional Modes.....	19	Information	33

4 Revision History

NOTE: Page numbers for previous revisions may differ from page numbers in the current version.

Changes from Revision A (February 2018) to Revision B	Page
• Added new RTK (VQFN) package and associated content.....	1
• Changed plots at $I_{OUT} > 2\text{ A}$ in <i>Typical Characteristics</i> section to match values shown in <i>Specifications</i> section	7
• Changed all I_{OUT} test conditions from 3 A to 2 A to match values shown in <i>Specifications</i> section	7
• Changed all plots to use default $C_{OUT} = 22\ \mu\text{F}$	7
• Changed Figure 48 to load transient plot.....	29
• Changed Figure 49 to noise plot	29

Changes from Original (September 2017) to Revision A	Page
• Changed from product preview to production data (active).....	1

5 Pin Configuration and Functions

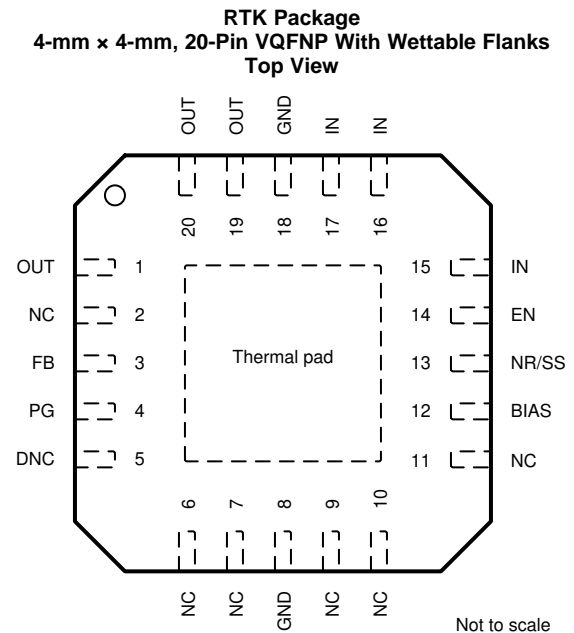
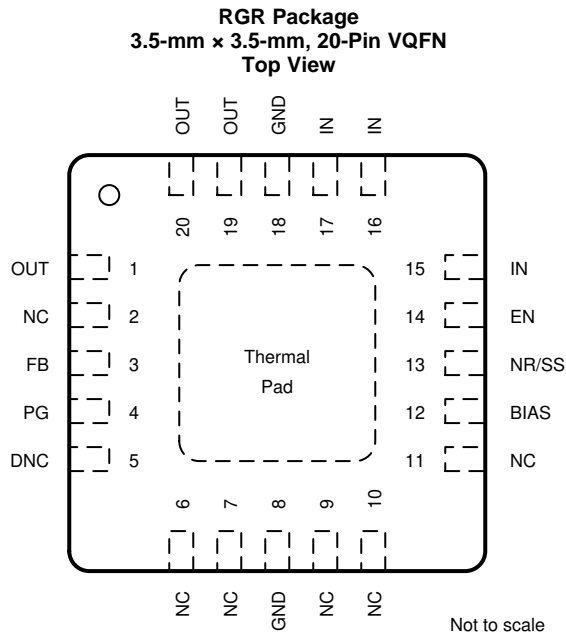

Pin Functions

PIN			DESCRIPTION
NAME	NO.	I/O	
BIAS	12	I	BIAS supply voltage. This pin enables the use of low-input voltage, low-output (LILO) voltage conditions (that is, $V_{IN} = 1.2\text{ V}$, $V_{OUT} = 1\text{ V}$) to reduce power dissipation across the die. The use of a BIAS voltage improves dc and ac performance for $V_{IN} \leq 2.2\text{ V}$. A 10- μF capacitor or larger must be connected between this pin and ground. If not used, this pin must be left floating or tied to ground.
DNC	5	—	Do not connect
EN	14	I	Enable pin. Driving this pin to logic high enables the device; driving this pin to logic low disables the device. If enable functionality is not required, this pin must be connected to IN or BIAS.
FB	3	I	Feedback pin connected to the error amplifier. Although not required, a 10-nF feed-forward capacitor from FB to OUT (as close to the device as possible) is recommended to maximize ac performance. The use of a feed-forward capacitor can disrupt PG (power good) functionality.
GND	8, 18	—	Ground pin. These pins must be connected to ground, the thermal pad, and each other with a low-impedance connection.
IN	15-17	I	Input supply voltage pin. A 10- μF or larger ceramic capacitor (5 μF or greater of capacitance) from IN to ground is recommended to reduce the impedance of the input supply. Place the input capacitor as close to the input as possible.
NC	2, 6, 7, 9, 10, 11	—	No internal connection
NR/SS	13	—	Noise-reduction and soft-start pin. Connecting an external capacitor between this pin and ground reduces reference voltage noise and also enables the soft-start function. Although not required, a 10-nF or larger capacitor is recommended to be connected from NR/SS to GND (as close to the pin as possible) to maximize ac performance.
OUT	1, 19, 20	O	Regulated output pin. A 22- μF or larger ceramic capacitor (10 μF or greater of capacitance) from OUT to ground is required for stability and must be placed as close to the output as possible. Minimize the impedance from the OUT pin to the load.
PG	4	O	Active-high, power-good pin. An open-drain output indicates when the output voltage reaches $V_{IT(PG)}$ of the target. The use of a feed-forward capacitor may disrupt PG (power good) functionality.
Thermal pad	Thermal pad	—	Connect the thermal pad to a large-area ground plane. The thermal pad is internally connected to GND.

6 Specifications

6.1 Absolute Maximum Ratings

 over junction temperature range (unless otherwise noted)⁽¹⁾

		MIN	MAX	UNIT
Voltage	IN, BIAS, PG, EN	-0.3	7.0	V
	IN, BIAS, PG, EN (5% duty cycle, pulse duration = 200 μ s)	-0.3	7.5	
	OUT ⁽²⁾	-0.3	$V_{IN} + 0.3$	
	NR/SS, FB	-0.3	3.6	
Current	OUT	Internally limited		A
	PG (sink current into device)		5	mA
Temperature	Operating junction, T_J	-55	150	$^{\circ}$ C
	Storage, T_{stg}	-55	150	

- (1) Stresses beyond those listed under *Absolute Maximum Ratings* may cause permanent damage to the device. These are stress ratings only, which do not imply functional operation of the device at these or any other conditions beyond those indicated under *Recommended Operating Conditions*. Exposure to absolute-maximum-rated conditions for extended periods may affect device reliability.
- (2) The absolute maximum rating is $V_{IN} + 0.3$ V or 7.0 V, whichever is smaller.

6.2 ESD Ratings

		VALUE	UNIT
$V_{(ESD)}$ Electrostatic discharge	Human-body model (HBM), per AEC Q100-002 ⁽¹⁾	± 2000	V
	Charged-device model (CDM), per AEC Q100-011	± 500	

- (1) AEC Q100-002 indicates that HBM stressing shall be in accordance with the ANSI/ESDA/JEDEC JS-001 specification.

6.3 Recommended Operating Conditions

over junction temperature range (unless otherwise noted)

		MIN	NOM	MAX	UNIT
V_{IN}	Input supply voltage range	1.1		6.5	V
V_{BIAS}	Bias supply voltage range ⁽¹⁾	3.0		6.5	V
V_{OUT}	Output voltage range ⁽²⁾	0.8		5	V
V_{EN}	Enable voltage range	0		V_{IN}	V
I_{OUT}	Output current	0		2	A
C_{IN}	Input capacitor	10	22		μ F
C_{BIAS}	Bias capacitor	10			μ F
R_{PG}	Power-good pullup resistance	10		100	k Ω
$C_{NR/SS}$	NR/SS capacitor		10		nF
C_{FF}	Feed-forward capacitor		10		nF
R_1	Top resistor value in feedback network for adjustable operation ⁽³⁾		12.1		k Ω
R_2	Bottom resistor value in feedback network for adjustable operation		160		k Ω
T_J	Operating junction temperature	-40		150	$^{\circ}$ C

- (1) BIAS supply is required when the V_{IN} supply is below 1.4 V. Conversely, no BIAS supply is required when the V_{IN} supply is higher than or equal to 1.4 V. A BIAS supply helps improve dc and ac performance for $V_{IN} \leq 2.2$ V.
- (2) This output voltage range does not include device accuracy or accuracy of the feedback resistors.
- (3) The 12.1-k Ω resistor is selected to optimize PSRR and noise by matching the internal R_1 value.

6.4 Thermal Information

THERMAL METRIC ⁽¹⁾		TPS7A52-Q1		UNIT
		RGR (VQFN)	RTK (VQFNFP)	
		20 PINS	20 PINS	
R _{θJA}	Junction-to-ambient thermal resistance	43.4	39.9	°C/W
R _{θJC(top)}	Junction-to-case (top) thermal resistance	36.8	32.1	°C/W
R _{θJB}	Junction-to-board thermal resistance	17.6	16.9	°C/W
Ψ _{JT}	Junction-to-top characterization parameter	0.8	0.4	°C/W
Y _{JB}	Junction-to-board characterization parameter	17.6	16.9	°C/W
R _{θJC(bot)}	Junction-to-case (bottom) thermal resistance	3.4	1.6	°C/W

(1) For more information about traditional and new thermal metrics, see the [Semiconductor and IC Package Thermal Metrics](#) application report.

6.5 Electrical Characteristics

over operating junction temperature range ($T_J = -40^\circ\text{C}$ to $+150^\circ\text{C}$), $V_{IN} = 1.4\text{ V}$ or $V_{IN} = V_{OUT(nom)} + 0.4\text{ V}$ (whichever is greater), $V_{BIAS} = \text{open}$, $V_{OUT(nom)} = 0.8\text{ V}^{(1)}$, OUT connected to $50\ \Omega$ to GND⁽²⁾, $V_{EN} = 1.1\text{ V}$, $C_{IN} = 10\ \mu\text{F}$, $C_{OUT} = 22\ \mu\text{F}$, $C_{NR/SS}$ without C_{FF} , and PG pin pulled up to V_{IN} with $100\text{ k}\Omega$ (unless otherwise noted); typical values are at $T_J = 25^\circ\text{C}$

PARAMETER		TEST CONDITIONS	MIN	TYP	MAX	UNIT
V _{FB}	Feedback voltage			0.8		V
V _{NR/SS}	NR/SS pin voltage			0.8		V
V _{UVLO1+(IN)}	Rising input supply UVLO with BIAS	V _{IN} rising with V _{BIAS} = 3.0 V		1.02	1.09	V
V _{HYS1(IN)}	V _{UVLO1(IN)} hysteresis	V _{BIAS} = 3.0 V		320		mV
V _{UVLO1-(IN)}	Falling input supply UVLO with BIAS	V _{IN} falling with V _{BIAS} = 3.0 V	0.55	0.711		V
V _{UVLO2+(IN)}	Rising input supply UVLO without BIAS	V _{IN} rising		1.31	1.39	V
V _{HYS2(IN)}	V _{UVLO2(IN)} hysteresis			253		mV
V _{UVLO2-(IN)}	Falling input supply UVLO without BIAS	V _{IN} falling	0.65	1.064		V
V _{UVLO+(BIAS)}	Rising bias supply UVLO	V _{BIAS} rising, V _{IN} = 1.1 V		2.83	2.9	V
V _{UVLO-(BIAS)}	Falling bias supply UVLO	V _{BIAS} falling, V _{IN} = 1.1 V	2.45	2.531		V
V _{HYS(BIAS)}	V _{UVLO(BIAS)} hysteresis	V _{IN} = 1.1 V		290		mV
V _{OUT}	Output voltage	Range		0.8	5.2	V
		Accuracy	0.8 V ≤ V _{OUT} ≤ 5.15 V, 5 mA ≤ I _{OUT} ≤ 2 A, over V _{IN} , -40°C < T _J < 150°C	-2.0%		1.0%
		Accuracy with BIAS	V _{IN} = 1.1 V, 5 mA ≤ I _{OUT} ≤ 2 A, 3.0 V ≤ V _{BIAS} ≤ 6.5 V, -40°C < T _J < 150°C	-1.75%		0.75%
		Accuracy	0.8 V ≤ V _{OUT} ≤ 5.15 V, 5 mA ≤ I _{OUT} ≤ 2 A, over V _{IN} , -40°C < T _J < 125°C	-1%		1%
		Accuracy with BIAS	V _{IN} = 1.1 V, 5 mA ≤ I _{OUT} ≤ 2 A, 3.0 V ≤ V _{BIAS} ≤ 6.5 V, -40°C < T _J < 125°C	-0.75%		0.75%
ΔV _{OUT} /ΔV _{IN}	Line regulation	I _{OUT} = 5 mA, 1.4 V ≤ V _{IN} ≤ 6.5 V		0.03		mV/V
ΔV _{OUT} /ΔI _{OUT}	Load regulation	5 mA ≤ I _{OUT} ≤ 2 A, 3.0 V ≤ V _{BIAS} ≤ 6.5 V, V _{IN} = 1.1 V		0.07		mV/A
		5 mA ≤ I _{OUT} ≤ 2 A		0.08		
		5 mA ≤ I _{OUT} ≤ 2 A, V _{OUT} = 5.2 V		0.04		
V _{DO}	RGR package	V _{IN} = 1.4 V, I _{OUT} = 2 A, V _{FB} = 0.8 V - 3%		103	190	mV
		V _{IN} = 5.3 V, I _{OUT} = 2 A, V _{FB} = 0.8 V - 3%		135	220	
		V _{IN} = 5.5 V, I _{OUT} = 2 A, V _{FB} = 0.8 V - 3%		157	300	
		V _{IN} = 1.1 V, 3.0 V ≤ V _{BIAS} ≤ 6.5 V, I _{OUT} = 2 A, V _{FB} = 0.8 V - 3%		73	120	
	RTK package	V _{IN} = 1.4 V, I _{OUT} = 2 A, V _{FB} = 0.8 V - 3%			215	mV
		V _{IN} = 5.3 V, I _{OUT} = 2 A, V _{FB} = 0.8 V - 3%			265	
		V _{IN} = 5.5 V, I _{OUT} = 2 A, V _{FB} = 0.8 V - 3%			340	
		V _{IN} = 1.1 V, 3.0 V ≤ V _{BIAS} ≤ 6.5 V, I _{OUT} = 2 A, V _{FB} = 0.8 V - 3%			145	

(1) V_{OUT(nom)} is the expected V_{OUT} value set by the external feedback resistors.

(2) This 50-Ω load is disconnected when the test conditions specify an I_{OUT} value.

Electrical Characteristics (continued)

over operating junction temperature range ($T_J = -40^\circ\text{C}$ to $+150^\circ\text{C}$), $V_{IN} = 1.4\text{ V}$ or $V_{IN} = V_{OUT(nom)} + 0.4\text{ V}$ (whichever is greater), $V_{BIAS} = \text{open}$, $V_{OUT(nom)} = 0.8\text{ V}^{(1)}$, OUT connected to $50\ \Omega$ to GND⁽²⁾, $V_{EN} = 1.1\text{ V}$, $C_{IN} = 10\ \mu\text{F}$, $C_{OUT} = 22\ \mu\text{F}$, $C_{NR/SS}$ without C_{FF} , and PG pin pulled up to V_{IN} with $100\text{ k}\Omega$ (unless otherwise noted); typical values are at $T_J = 25^\circ\text{C}$

PARAMETER	TEST CONDITIONS	MIN	TYP	MAX	UNIT
I_{LIM}	Output current limit V_{OUT} forced at $0.9 \times V_{OUT(nom)}$, $V_{IN} = V_{OUT(nom)} + 0.4\text{ V}$	2.7	3.3	4	A
I_{SC}	Short-circuit current limit $R_{LOAD} = 20\text{ m}\Omega$		1.0		A
I_{GND}	$V_{IN} = 6.5\text{ V}$, $I_{OUT} = 5\text{ mA}$		3	4	mA
	$V_{IN} = 1.4\text{ V}$, $I_{OUT} = 2\text{ A}$		3.7	5	
	Shutdown, PG = open, $V_{IN} = 6.5\text{ V}$, $V_{EN} = 0.5\text{ V}$			25	μA
I_{EN}	EN pin current $V_{IN} = 6.5\text{ V}$, $V_{EN} = 0\text{ V}$ and 6.5 V	-0.5		0.5	μA
I_{BIAS}	BIAS pin current $V_{IN} = 1.1\text{ V}$, $V_{BIAS} = 6.5\text{ V}$, $V_{OUT(nom)} = 0.8\text{ V}$, $I_{OUT} = 2\text{ A}$		2.3	3.5	mA
$V_{IL(EN)}$	EN pin low-level input voltage (disable device)			0.5	V
$V_{IH(EN)}$	EN pin high-level input voltage (enable device)	1.1			V
$V_{IT-(PG)}$	PG pin threshold For falling V_{OUT}	$0.82V_{OUT}$	$0.88V_{OUT}$	$0.93V_{OUT}$	V
$V_{HYS(PG)}$	PG pin hysteresis		$0.02V_{OUT}$		V
$V_{IT+(PG)}$	PG pin threshold For rising V_{OUT}	$0.84V_{OUT}$	$0.90V_{OUT}$	$0.95V_{OUT}$	V
$V_{OL(PG)}$	PG pin low-level output voltage $V_{OUT} < V_{IT(PG)}$, $I_{PG} = -1\text{ mA}$ (current into device)			0.4	V
$I_{kG(PG)}$	PG pin leakage current $V_{OUT} > V_{IT(PG)}$, $V_{PG} = 6.5\text{ V}$			1	μA
$I_{NR/SS}$	NR/SS pin charging current $V_{NR/SS} = \text{GND}$, $V_{IN} = 6.5\text{ V}$	4.0	6.5	10	μA
I_{FB}	FB pin leakage current $V_{IN} = 6.5\text{ V}$	-100		100	nA
PSRR	Power-supply ripple rejection $V_{IN} - V_{OUT} = 0.4\text{ V}$, $I_{OUT} = 2\text{ A}$, $C_{NR/SS} = 100\text{ nF}$, $C_{FF} = 10\text{ nF}$, $C_{OUT} = 22\ \mu\text{F}$	$f = 10\text{ kHz}$, $V_{OUT} = 0.8\text{ V}$, $V_{BIAS} = 5.0\text{ V}$		42	dB
		$f = 500\text{ kHz}$, $V_{OUT} = 0.8\text{ V}$, $V_{BIAS} = 5.0\text{ V}$		39	
		$f = 10\text{ kHz}$, $V_{OUT} = 5.0\text{ V}$		40	
		$f = 500\text{ kHz}$, $V_{OUT} = 5.0\text{ V}$		25	
V_n	Output noise voltage $BW = 10\text{ Hz to }100\text{ kHz}$, $V_{IN} = 1.1\text{ V}$, $V_{OUT} = 0.8\text{ V}$, $V_{BIAS} = 5.0\text{ V}$, $I_{OUT} = 2\text{ A}$, $C_{NR/SS} = 100\text{ nF}$, $C_{FF} = 10\text{ nF}$, $C_{OUT} = 22\ \mu\text{F}$		4.4		μV_{RMS}
		$BW = 10\text{ Hz to }100\text{ kHz}$, $V_{OUT} = 5.0\text{ V}$, $I_{OUT} = 2\text{ A}$, $C_{NR/SS} = 100\text{ nF}$, $C_{FF} = 10\text{ nF}$, $C_{OUT} = 22\ \mu\text{F}$		7.7	
T_{SD}	Thermal shutdown temperature	Shutdown, temperature increasing		160	$^\circ\text{C}$
		Reset, temperature decreasing		140	

6.6 Typical Characteristics

at $T_A = 25^\circ\text{C}$, $V_{IN} = 1.4\text{ V}$ or $V_{IN} = V_{OUT(NOM)} + 0.4\text{ V}$ (whichever is greater), $V_{BIAS} = \text{open}$, $V_{OUT(NOM)} = 0.8\text{ V}$, $V_{EN} = 1.1\text{ V}$, $C_{OUT} = 22\text{ }\mu\text{F}$, $C_{NR/SS} = 0\text{ nF}$, $C_{FF} = 0\text{ nF}$, and PG pin pulled up to V_{IN} with $100\text{ k}\Omega$ (unless otherwise noted)

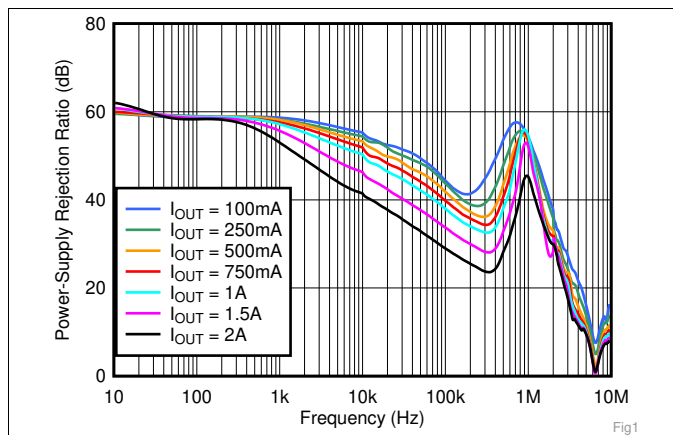

$V_{IN} = 1.1\text{ V}$, $V_{BIAS} = 5\text{ V}$, $C_{NR/SS} = 10\text{ nF}$, $C_{FF} = 10\text{ nF}$

Figure 1. PSRR vs Frequency and I_{OUT}

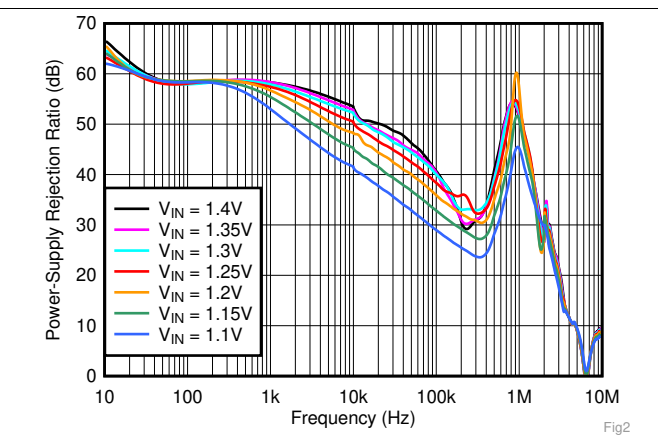

$I_{OUT} = 2\text{ A}$, $V_{BIAS} = 5\text{ V}$, $C_{NR/SS} = 10\text{ nF}$, $C_{FF} = 10\text{ nF}$

Figure 2. PSRR vs Frequency and V_{IN} With Bias

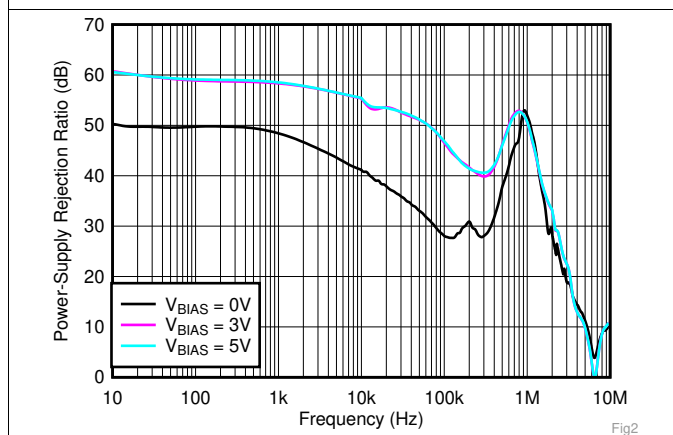

$V_{IN} = 1.4\text{ V}$, $I_{OUT} = 1\text{ A}$, $C_{NR/SS} = 10\text{ nF}$, $C_{FF} = 10\text{ nF}$

Figure 3. PSRR vs Frequency and V_{BIAS}

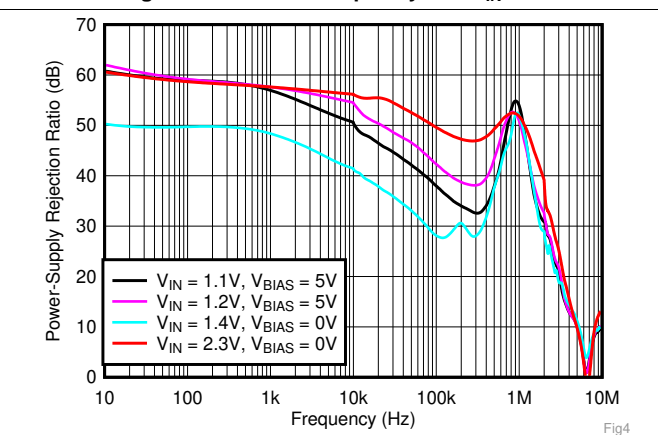

$I_{OUT} = 1\text{ A}$, $C_{NR/SS} = 10\text{ nF}$, $C_{FF} = 10\text{ nF}$

Figure 4. PSRR vs Frequency and V_{IN}

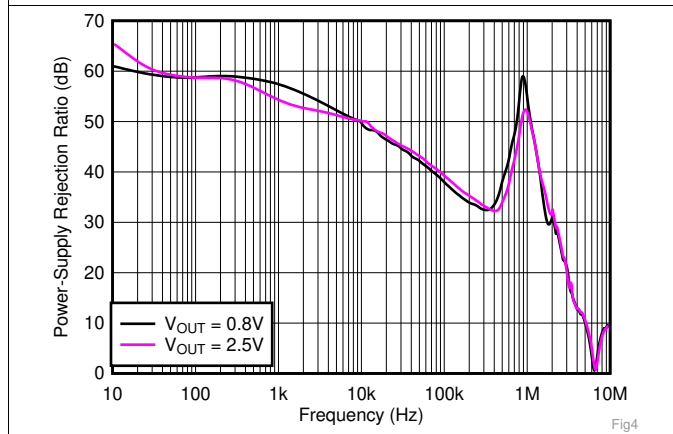

$V_{IN} = V_{OUT} + 0.3\text{ V}$, $V_{BIAS} = 5.0\text{ V}$, $I_{OUT} = 2\text{ A}$, $C_{NR/SS} = 10\text{ nF}$, $C_{FF} = 10\text{ nF}$

Figure 5. PSRR vs Frequency and V_{OUT} With Bias

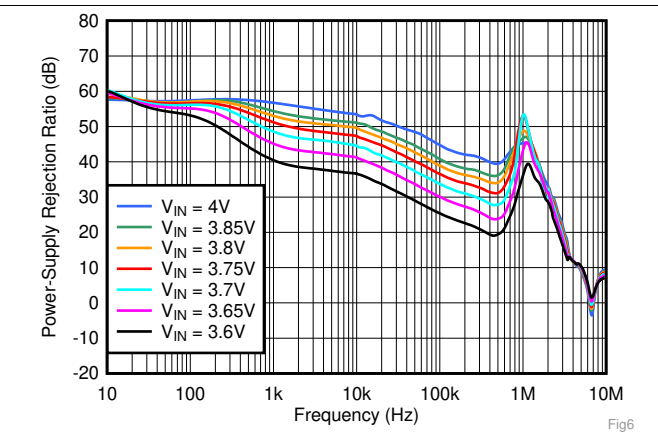

$V_{OUT} = 3.3\text{ V}$, $I_{OUT} = 2\text{ A}$, $C_{NR/SS} = 10\text{ nF}$, $C_{FF} = 10\text{ nF}$

Figure 6. PSRR vs Frequency and V_{IN} for $V_{OUT} = 3.3\text{ V}$

Typical Characteristics (continued)

at $T_A = 25^\circ\text{C}$, $V_{IN} = 1.4\text{ V}$ or $V_{IN} = V_{OUT(NOM)} + 0.4\text{ V}$ (whichever is greater), $V_{BIAS} = \text{open}$, $V_{OUT(NOM)} = 0.8\text{ V}$, $V_{EN} = 1.1\text{ V}$, $C_{OUT} = 22\text{ }\mu\text{F}$, $C_{NR/SS} = 0\text{ nF}$, $C_{FF} = 0\text{ nF}$, and PG pin pulled up to V_{IN} with $100\text{ k}\Omega$ (unless otherwise noted)

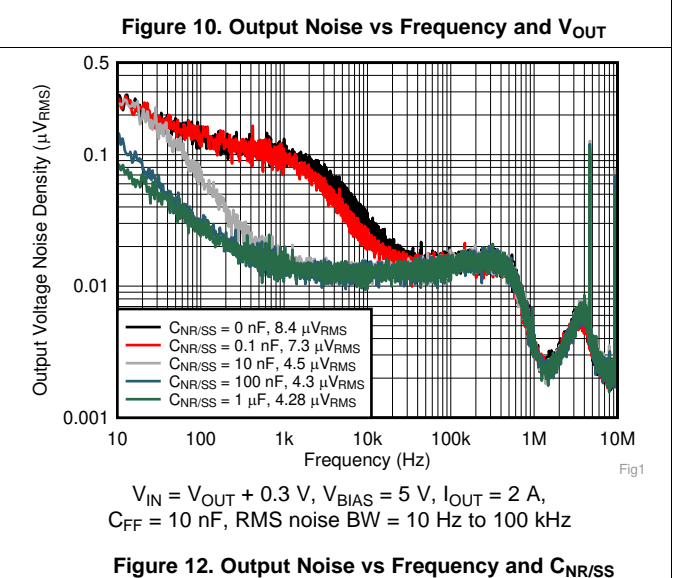
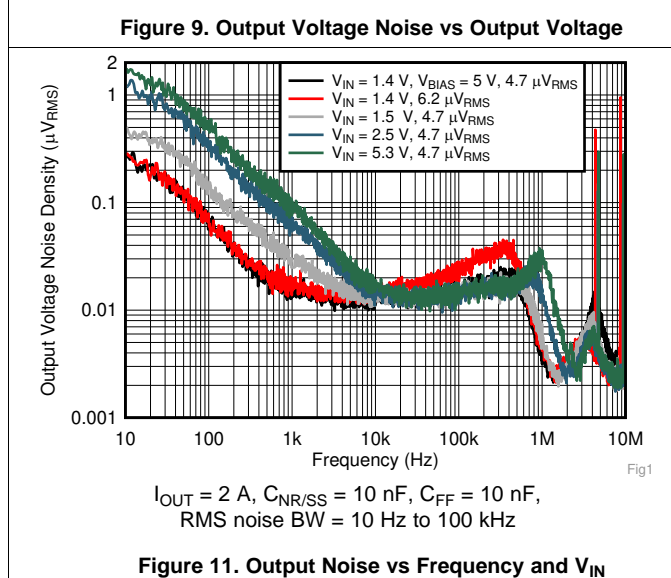
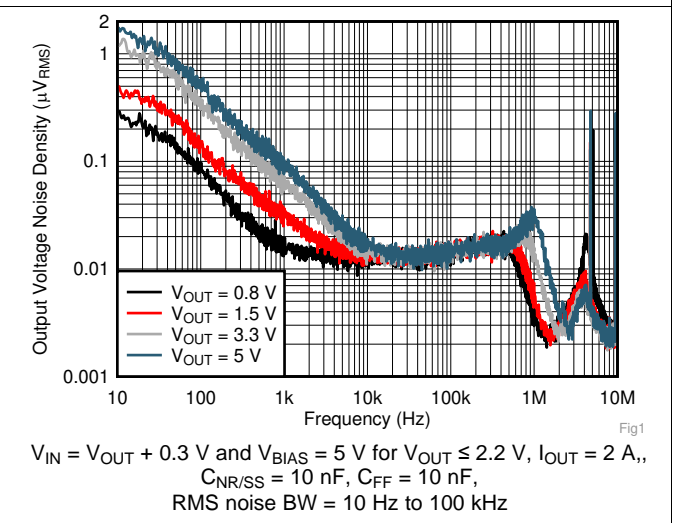
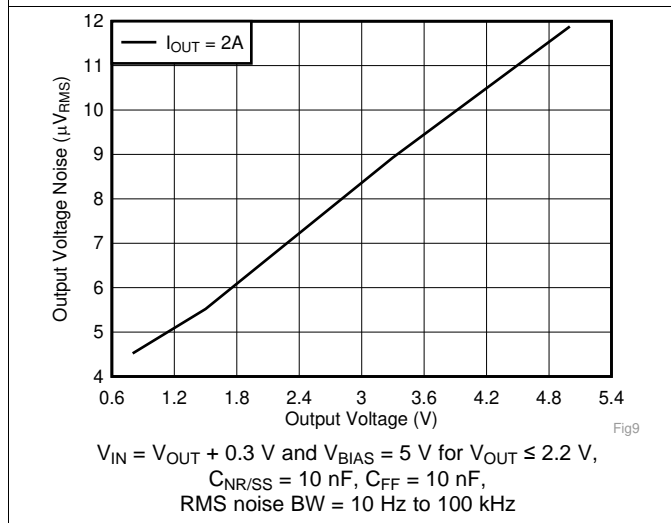
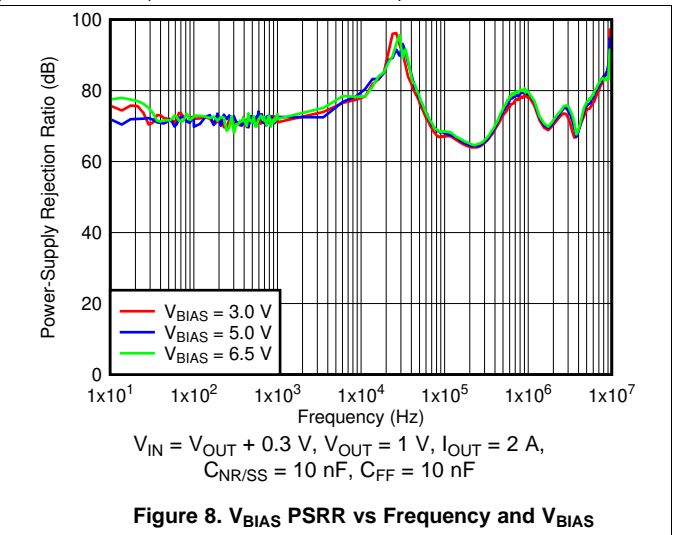
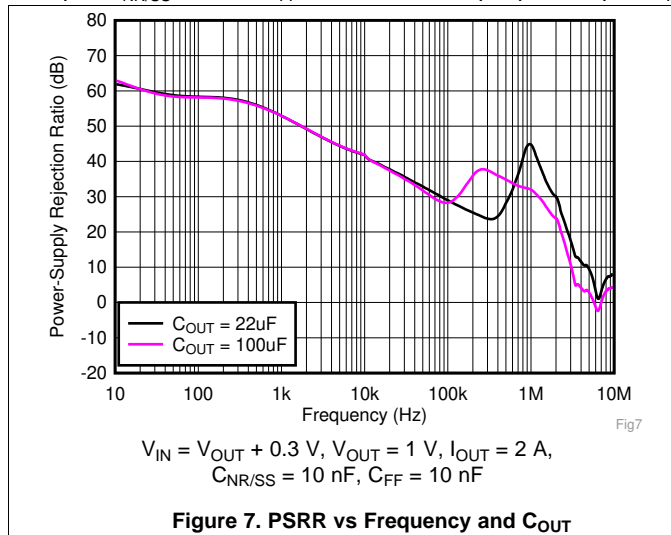

Typical Characteristics (continued)

at $T_A = 25^\circ\text{C}$, $V_{IN} = 1.4\text{ V}$ or $V_{IN} = V_{OUT(NOM)} + 0.4\text{ V}$ (whichever is greater), $V_{BIAS} = \text{open}$, $V_{OUT(NOM)} = 0.8\text{ V}$, $V_{EN} = 1.1\text{ V}$, $C_{OUT} = 22\text{ }\mu\text{F}$, $C_{NR/SS} = 0\text{ nF}$, $C_{FF} = 0\text{ nF}$, and PG pin pulled up to V_{IN} with $100\text{ k}\Omega$ (unless otherwise noted)

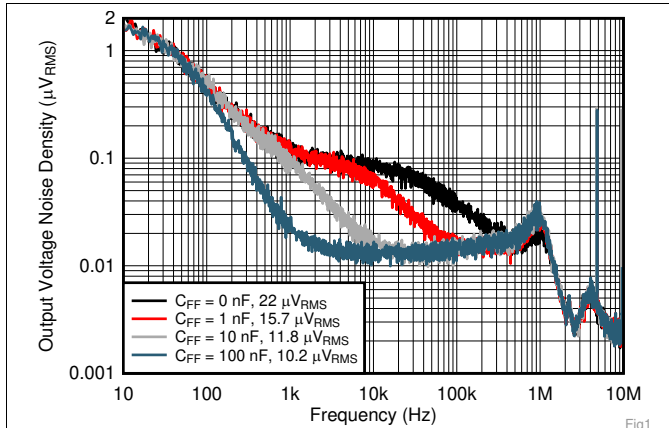

$V_{IN} = V_{OUT} + 0.3\text{ V}$, $V_{BIAS} = 5\text{ V}$, $I_{OUT} = 2\text{ A}$, sequencing with a dc-dc converter and PG, $C_{NR/SS} = 10\text{ nF}$, RMS noise BW = 10 Hz to 100 kHz

Figure 13. Output Noise vs Frequency and C_{FF}

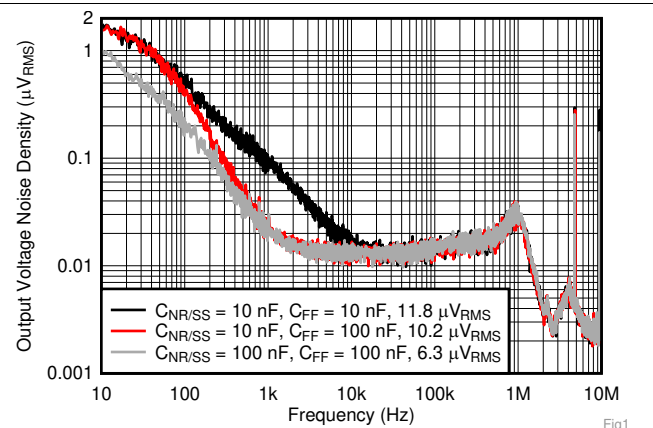

$V_{OUT} = 5\text{ V}$, $I_{OUT} = 2\text{ A}$, $C_{FF} = 10\text{ nF}$, RMS noise BW = 10 Hz to 100 kHz

Figure 14. Output Noise at $V_{OUT} = 5\text{ V}$

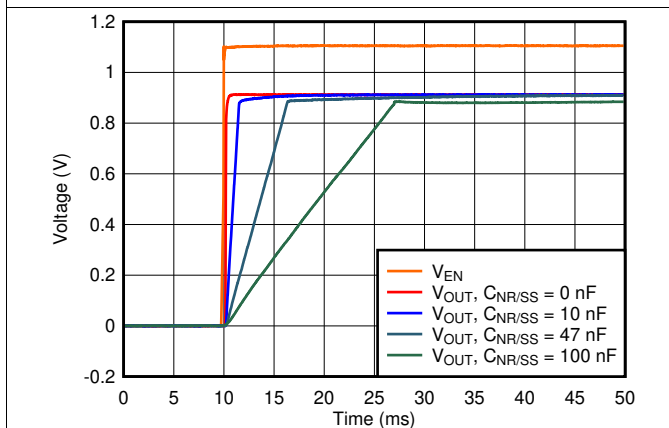

$V_{IN} = 1.2\text{ V}$, $V_{OUT} = 0.9\text{ V}$, $V_{BIAS} = 5.0\text{ V}$, $I_{OUT} = 2\text{ A}$, $C_{FF} = 10\text{ nF}$

Figure 15. Start-Up Waveform vs Time and $C_{NR/SS}$

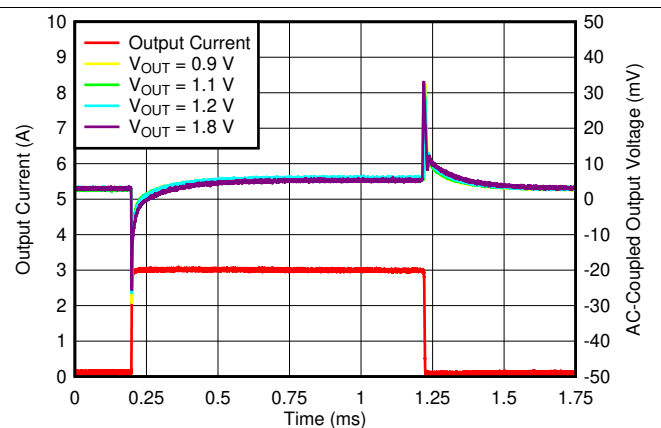

$V_{IN} = V_{OUT} + 0.3\text{ V}$, $V_{BIAS} = 5\text{ V}$, $I_{OUT, DC} = 100\text{ mA}$, slew rate = $1\text{ A}/\mu\text{s}$, $C_{NR/SS} = C_{FF} = 10\text{ nF}$

Figure 16. Load Transient vs Time and V_{OUT} With Bias

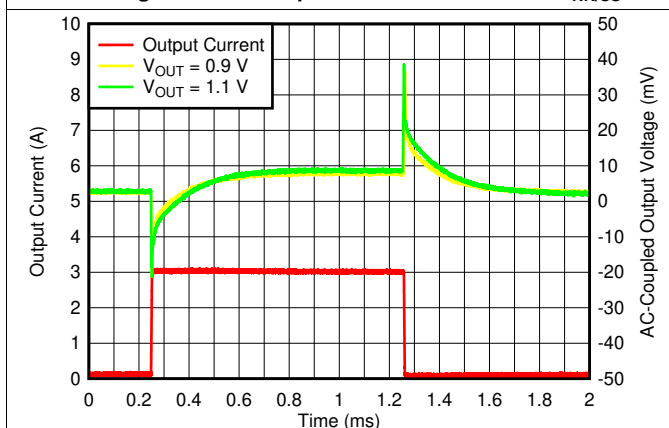

$I_{OUT, DC} = 100\text{ mA}$, $C_{NR/SS} = C_{FF} = 10\text{ nF}$, slew rate = $1\text{ A}/\mu\text{s}$

Figure 17. Load Transient vs Time and V_{OUT} Without Bias

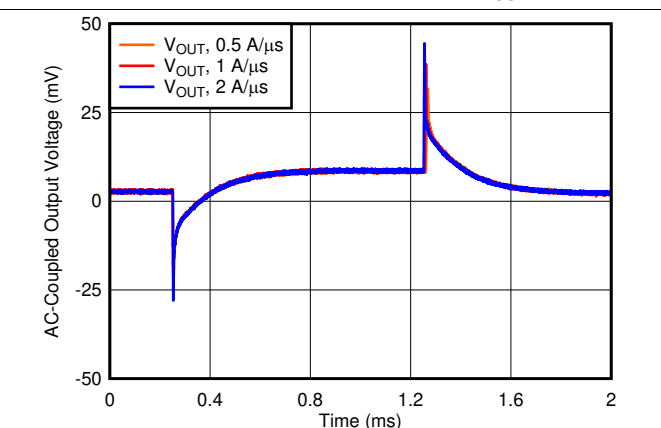

$V_{OUT} = 5\text{ V}$, $I_{OUT, DC} = 100\text{ mA}$, $I_{OUT} = 100\text{ mA}$ to 2 A , $C_{NR/SS} = C_{FF} = 10\text{ nF}$

Figure 18. Load Transient vs Time and Slew Rate

Typical Characteristics (continued)

at $T_A = 25^\circ\text{C}$, $V_{IN} = 1.4\text{ V}$ or $V_{IN} = V_{OUT(NOM)} + 0.4\text{ V}$ (whichever is greater), $V_{BIAS} = \text{open}$, $V_{OUT(NOM)} = 0.8\text{ V}$, $V_{EN} = 1.1\text{ V}$, $C_{OUT} = 22\text{ }\mu\text{F}$, $C_{NR/SS} = 0\text{ nF}$, $C_{FF} = 0\text{ nF}$, and PG pin pulled up to V_{IN} with $100\text{ k}\Omega$ (unless otherwise noted)

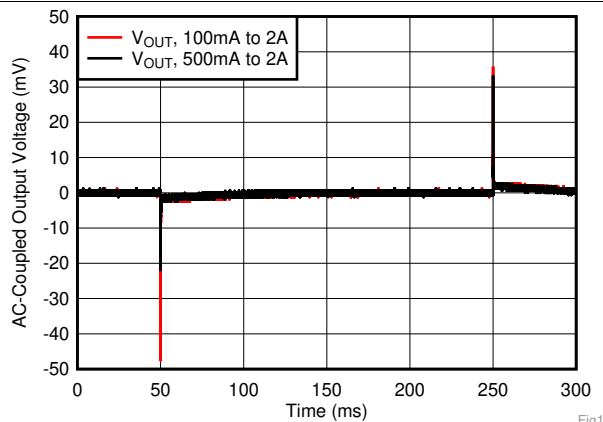

RGR package, $V_{OUT} = 0.9\text{ V}$, $V_{IN} = 1.2\text{ V}$, $V_{BIAS} = 5.0\text{ V}$, $C_{NR/SS} = C_{FF} = 10\text{ nF}$, slew rate = $1\text{ A}/\mu\text{s}$

Figure 19. Load Transient vs Time and DC Load

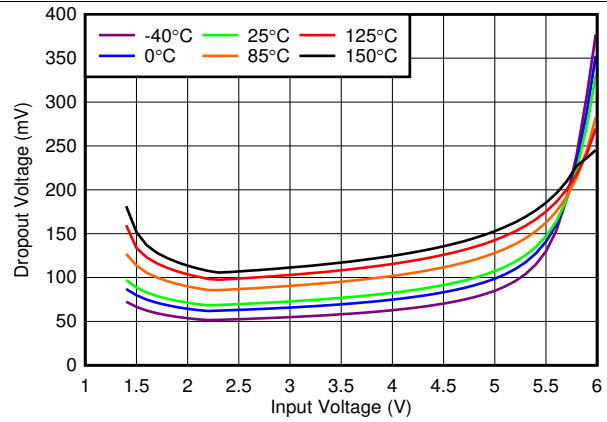

$I_{OUT} = 2\text{ A}$, $V_{BIAS} = 0\text{ V}$

Figure 20. Dropout Voltage vs Input Voltage Without Bias

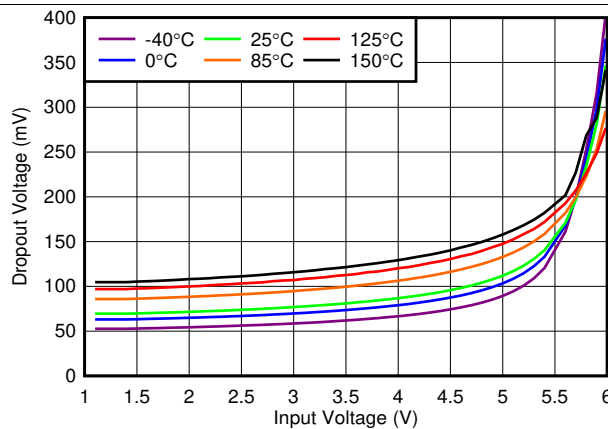

RGR package, $I_{OUT} = 2\text{ A}$, $V_{BIAS} = 6.5\text{ V}$

Figure 21. Dropout Voltage vs Input Voltage With Bias

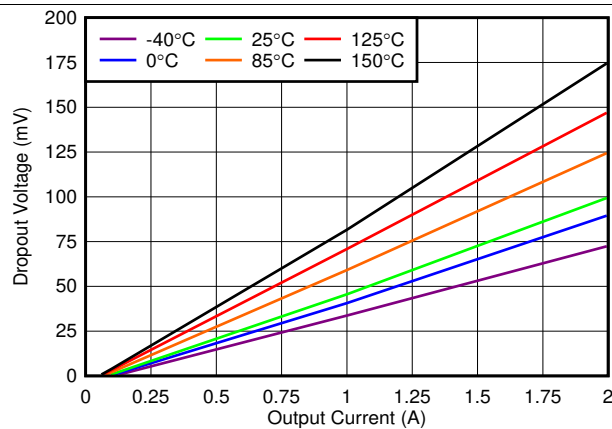

RGR package, $V_{IN} = 1.4\text{ V}$, $V_{BIAS} = 0\text{ V}$

Figure 22. Dropout Voltage vs Output Current Without Bias

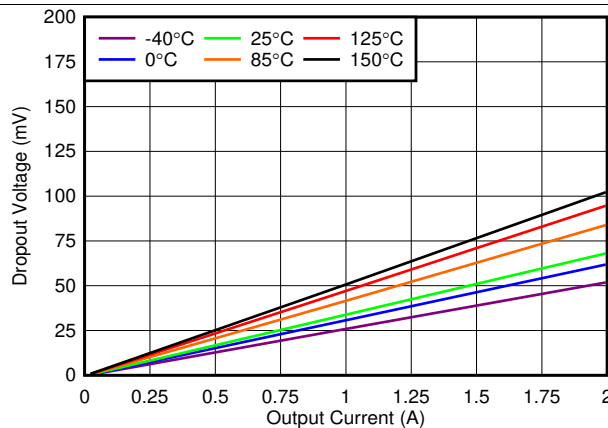

RGR package, $V_{IN} = 1.1\text{ V}$, $V_{BIAS} = 3\text{ V}$

Figure 23. Dropout Voltage vs Output Current With Bias

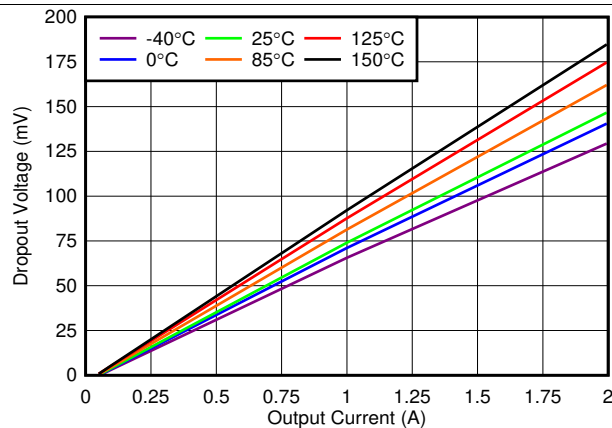

RGR package, $V_{IN} = 5.5\text{ V}$

Figure 24. Dropout Voltage vs Output Current (High V_{IN})

Typical Characteristics (continued)

at $T_A = 25^\circ\text{C}$, $V_{IN} = 1.4\text{ V}$ or $V_{IN} = V_{OUT(NOM)} + 0.4\text{ V}$ (whichever is greater), $V_{BIAS} = \text{open}$, $V_{OUT(NOM)} = 0.8\text{ V}$, $V_{EN} = 1.1\text{ V}$, $C_{OUT} = 22\text{ }\mu\text{F}$, $C_{NR/SS} = 0\text{ nF}$, $C_{FF} = 0\text{ nF}$, and PG pin pulled up to V_{IN} with $100\text{ k}\Omega$ (unless otherwise noted)

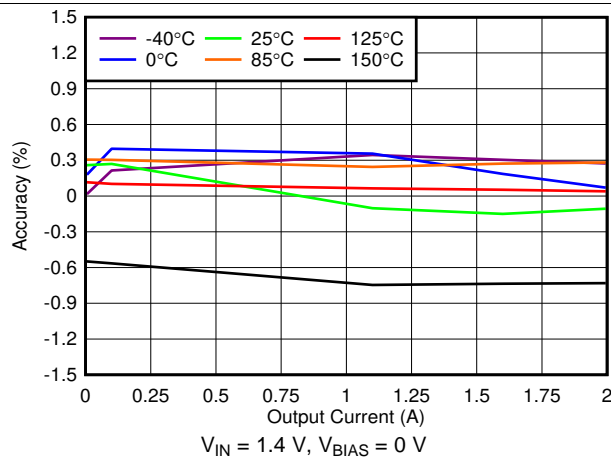

Figure 25. Load Regulation With Bias

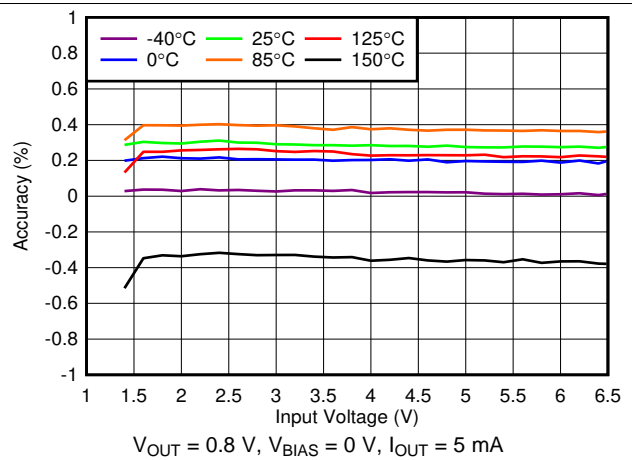

Figure 26. Line Regulation Without Bias

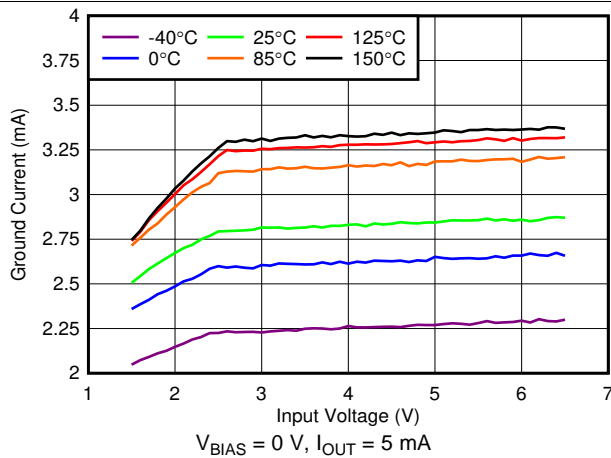

Figure 27. Ground Current vs Input Voltage

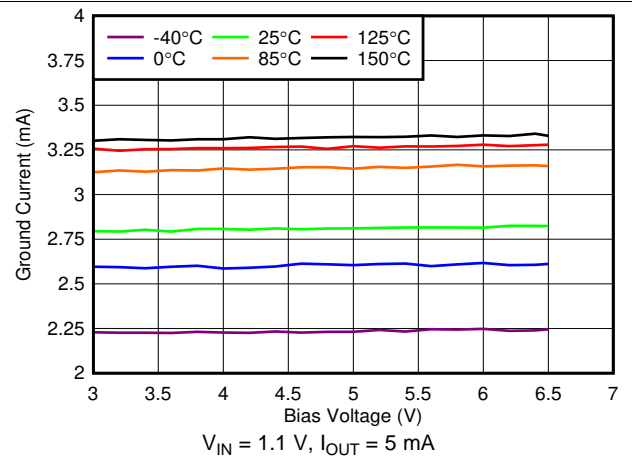

Figure 28. Ground Current vs Bias Voltage

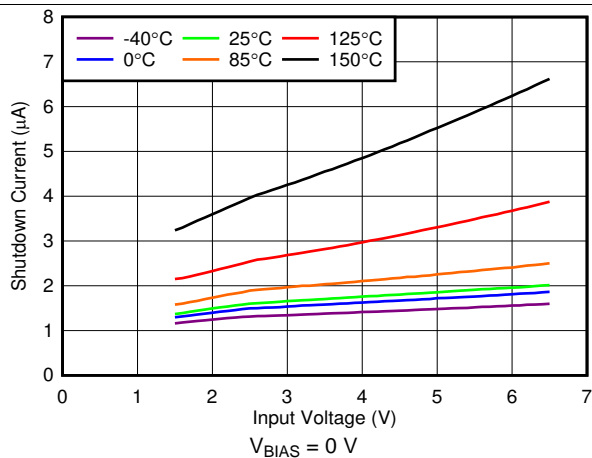

Figure 29. Shutdown Current vs Input Voltage

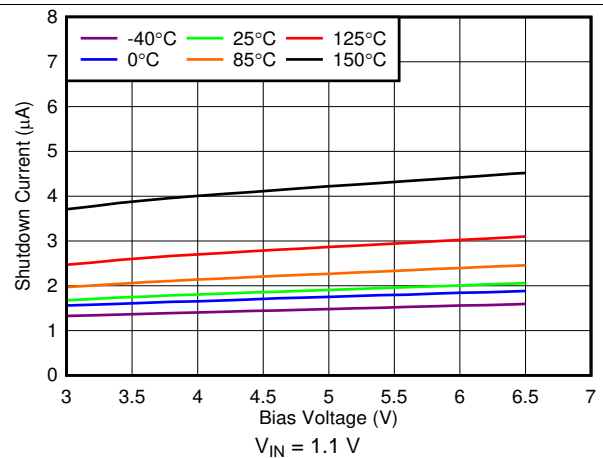

Figure 30. Shutdown Current vs Bias Voltage

Typical Characteristics (continued)

at $T_A = 25^\circ\text{C}$, $V_{IN} = 1.4\text{ V}$ or $V_{IN} = V_{OUT(NOM)} + 0.4\text{ V}$ (whichever is greater), $V_{BIAS} = \text{open}$, $V_{OUT(NOM)} = 0.8\text{ V}$, $V_{EN} = 1.1\text{ V}$, $C_{OUT} = 22\text{ }\mu\text{F}$, $C_{NR/SS} = 0\text{ nF}$, $C_{FF} = 0\text{ nF}$, and PG pin pulled up to V_{IN} with $100\text{ k}\Omega$ (unless otherwise noted)

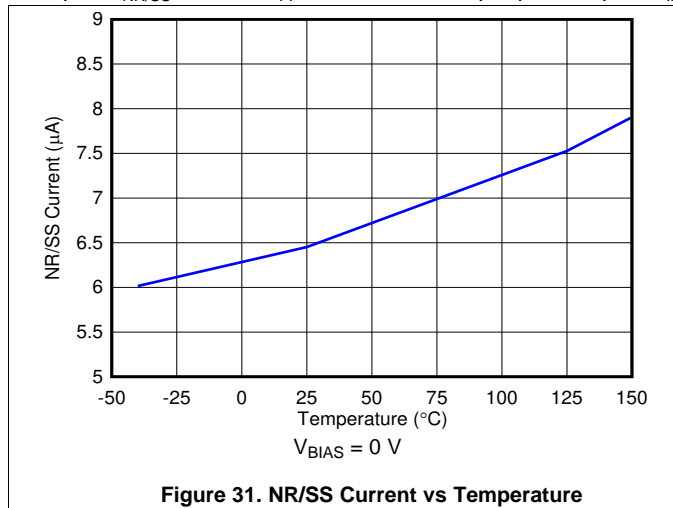

Figure 31. NR/SS Current vs Temperature

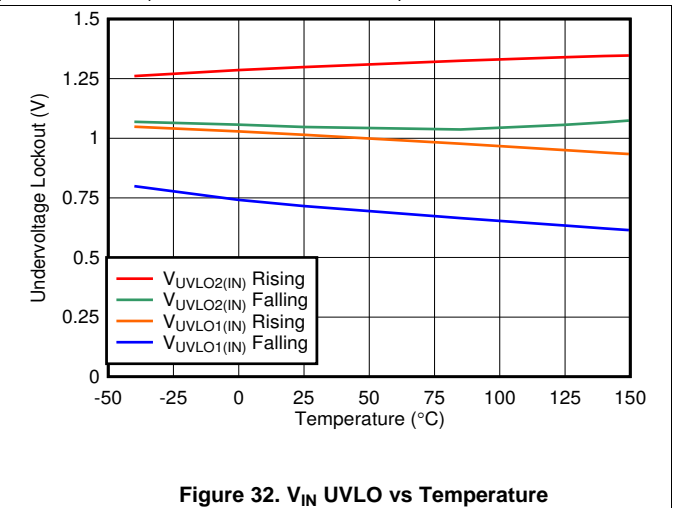

Figure 32. V_{IN} UVLO vs Temperature

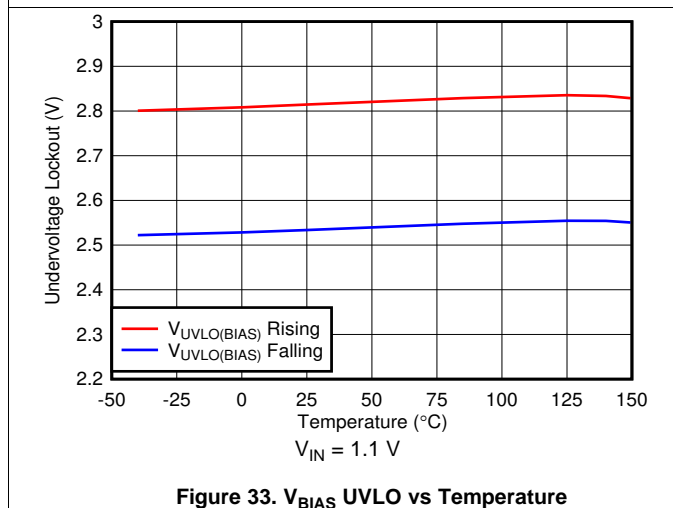

Figure 33. V_{BIAS} UVLO vs Temperature

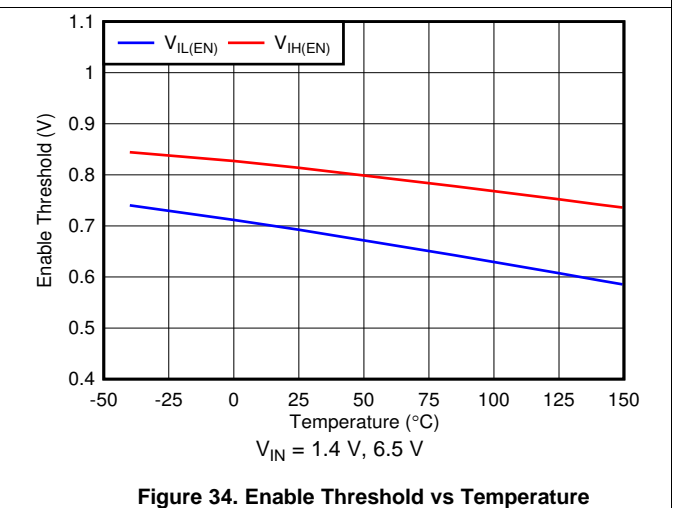

Figure 34. Enable Threshold vs Temperature

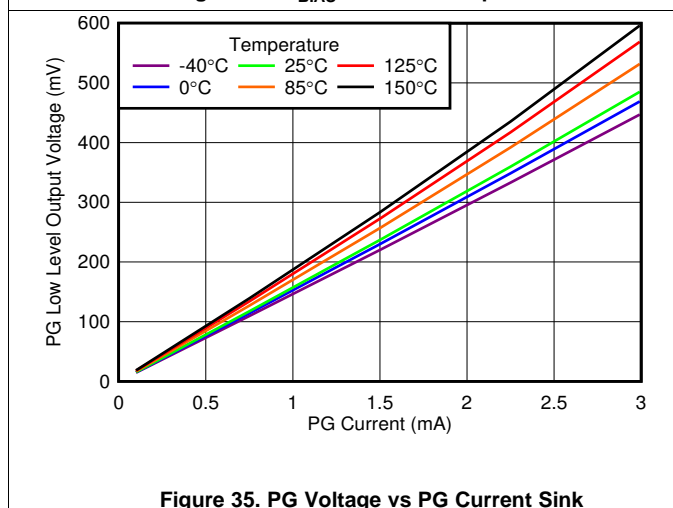

Figure 35. PG Voltage vs PG Current Sink

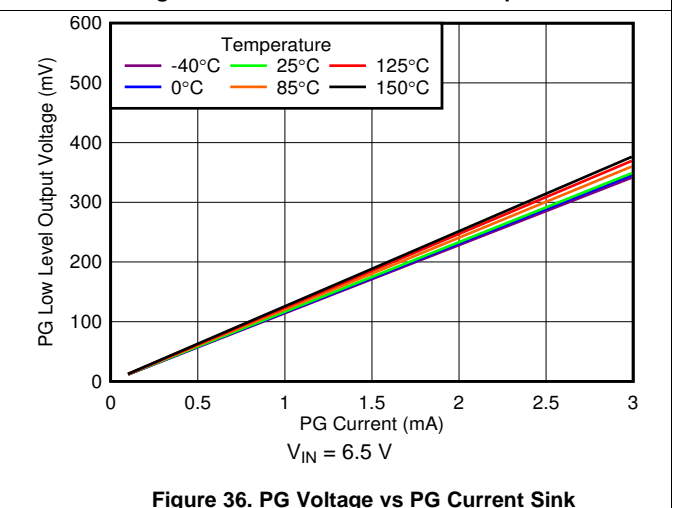
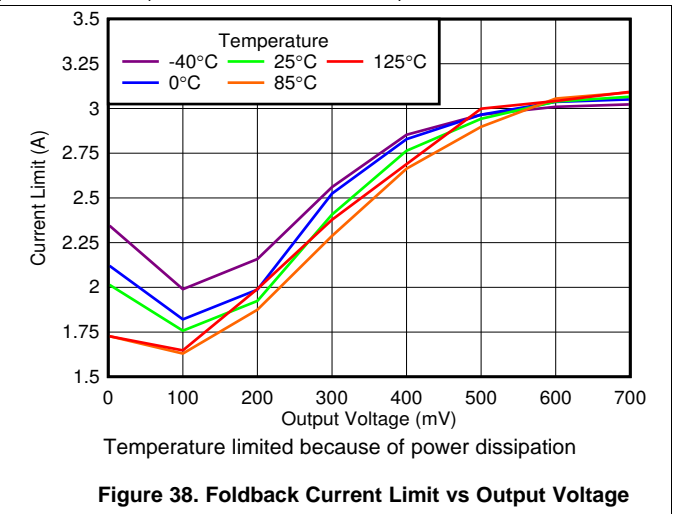
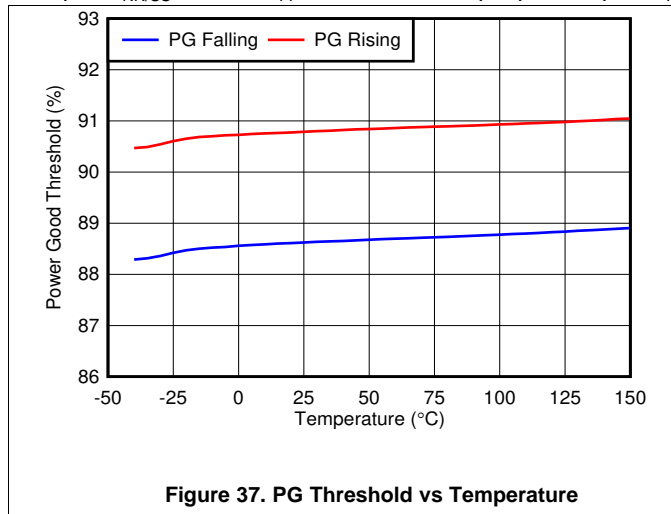

Figure 36. PG Voltage vs PG Current Sink

Typical Characteristics (continued)

at $T_A = 25^\circ\text{C}$, $V_{IN} = 1.4\text{ V}$ or $V_{IN} = V_{OUT(NOM)} + 0.4\text{ V}$ (whichever is greater), $V_{BIAS} = \text{open}$, $V_{OUT(NOM)} = 0.8\text{ V}$, $V_{EN} = 1.1\text{ V}$, $C_{OUT} = 22\ \mu\text{F}$, $C_{NR/SS} = 0\text{ nF}$, $C_{FF} = 0\text{ nF}$, and PG pin pulled up to V_{IN} with $100\text{ k}\Omega$ (unless otherwise noted)



7 Detailed Description

7.1 Overview

The TPS7A52-Q1 is a high-current (2 A), low-noise ($4.4 \mu V_{RMS}$), high accuracy (1%) low-dropout linear voltage regulator with an input range of 1.1 V to 6.5 V, an output voltage range of 0.8 V to 5.2 V. The TPS7A52-Q1 has an integrated charge pump for ease of use, and an external bias rail to allow for the lowest dropout across the entire output voltage range. [Table 1](#) categorizes the functions shown in the [Functional Block Diagram](#) section. These features make the TPS7A52-Q1 a robust solution to solve many challenging problems by generating a clean, accurate power supply in a variety of applications.

Table 1. Device Features

VOLTAGE REGULATION	SYSTEM START-UP	INTERNAL PROTECTION
High accuracy	Programmable soft start	Foldback current limit
Low-noise, high-PSRR output	No sequencing requirement between BIAS, IN, and EN	Thermal shutdown
Fast transient response	Power-good output	
	Start-up with negative bias on OUT	

7.2 Functional Block Diagram

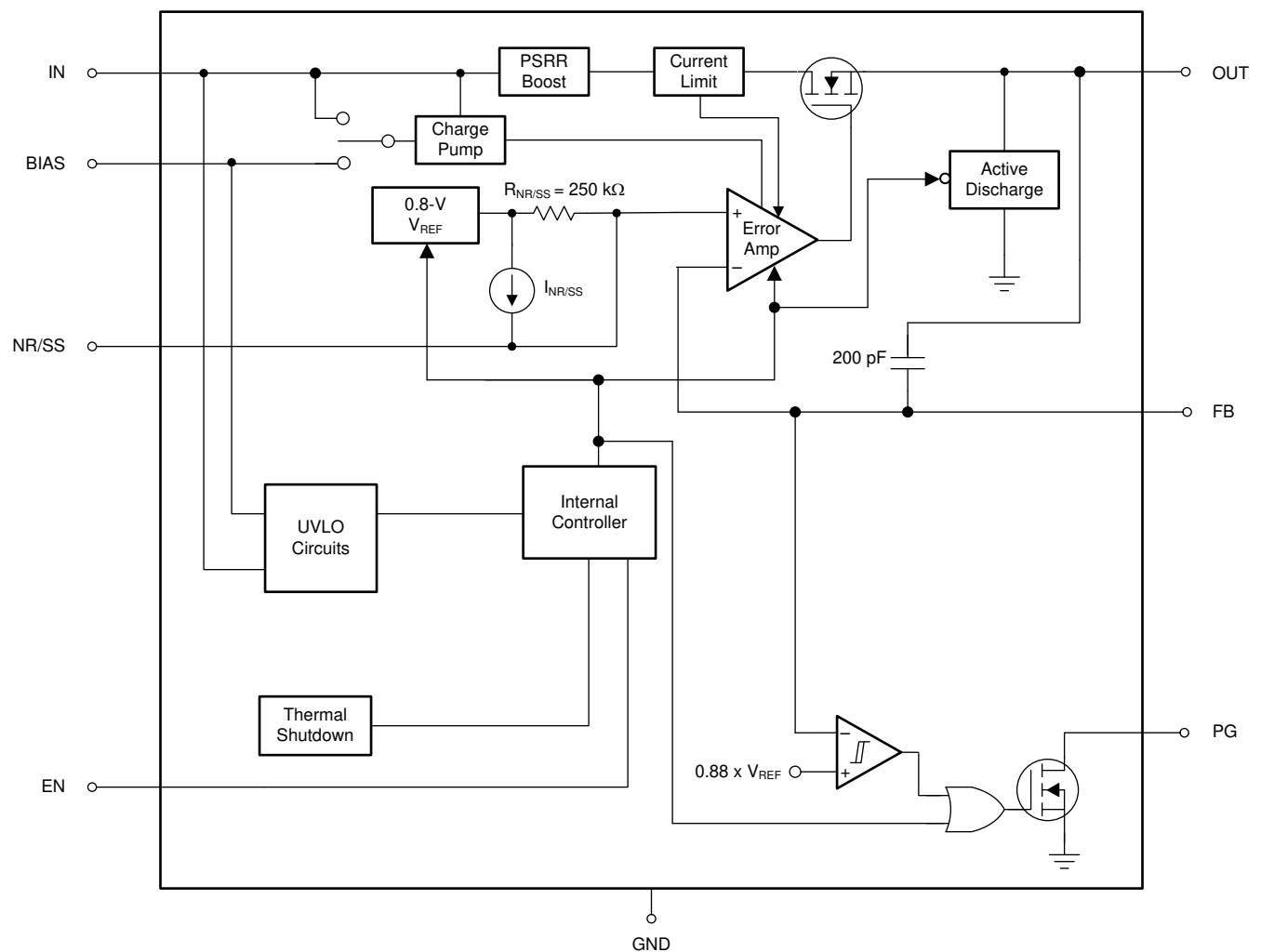

7.3 Feature Description

7.3.1 Voltage Regulation Features

7.3.1.1 DC Regulation

As shown in Figure 39, an LDO functions as a class-B amplifier in which the input signal is the internal reference voltage (V_{REF}). V_{REF} is designed to have a very low bandwidth at the input to the error amplifier through the use of a low-pass filter ($V_{NR/SS}$).

As such, the reference can be considered as a pure dc input signal. The low output impedance of an LDO comes from the combination of the output capacitor and pass element. The pass element also presents a high input impedance to the source voltage when operating as a current source. A positive LDO can only source current because of the class-B architecture.

This device achieves a maximum of 1% output voltage accuracy primarily because of the high-precision band-gap voltage (V_{BG}) that creates V_{REF} . The low dropout voltage (V_{DO}) reduces the thermal power dissipation required by the device to regulate the output voltage at a given current level, thereby improving system efficiency. These features combine to make this device a good approximation of an ideal voltage source.

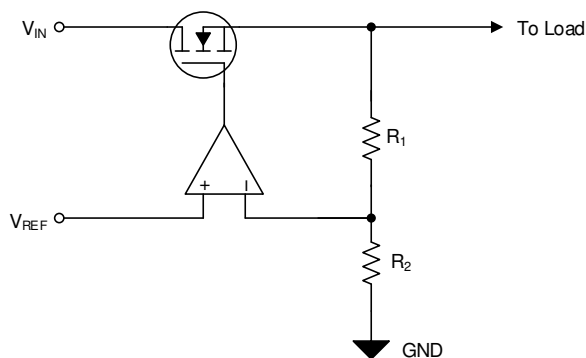

NOTE: $V_{OUT} = V_{REF} \times (1 + R_1 / R_2)$.

Figure 39. Simplified Regulation Circuit

7.3.1.2 AC and Transient Response

The LDO responds quickly to a transient (large-signal response) on the input supply (line transient) or the output current (load transient) resulting from the LDO high-input impedance and low output-impedance across frequency. This same capability also means that the LDO has a high power-supply rejection ratio (PSRR) and, when coupled with a low internal noise-floor (V_n), the LDO approximates an ideal power supply in ac (small-signal) and large-signal conditions.

The choice of external component values optimizes the small- and large-signal response. The NR/SS capacitor ($C_{NR/SS}$) and feed-forward capacitor (C_{FF}) easily reduce the device noise floor and improve PSRR.

Feature Description (continued)

7.3.2 System Start-Up Features

In many different applications, the power-supply output must turn on within a specific window of time to either provide proper operation of the load or to minimize the loading on the input supply or other sequencing requirements. The LDO start-up is well-controlled and user-adjustable, solving the demanding requirements faced by many power-supply design engineers in a simple fashion.

7.3.2.1 Programmable Soft Start (NR/SS Pin)

Soft start directly controls the output start-up time and indirectly controls the output current during start-up (inrush current).

The external capacitor at the NR/SS pin ($C_{NR/SS}$), as shown in Figure 40, sets the output start-up time by setting the rise time of the internal reference ($V_{NR/SS}$).

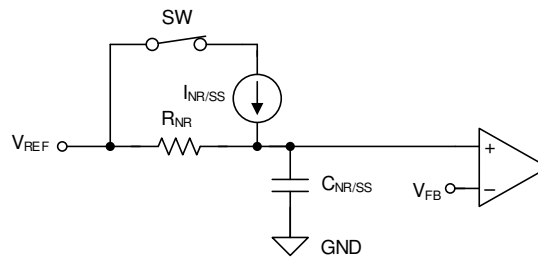

Figure 40. Simplified Soft-Start Circuit

7.3.2.2 Internal Sequencing

Controlling when a single power supply turns on can be difficult in a power distribution network (PDN) because of the high power levels inherent in a PDN, and the variations between all of the supplies. Figure 41 and Table 2 show that the LDO turnon and turnoff time is set by the enable circuit (EN) and undervoltage lockout circuits ($UVLO_{1,2(IN)}$ and $UVLO_{BIAS}$).

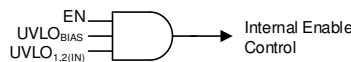

Figure 41. Simplified Turnon Control

Table 2. Internal Sequencing Functionality Table

INPUT VOLTAGE	BIAS VOLTAGE	ENABLE STATUS	LDO STATUS	ACTIVE DISCHARGE	POWER GOOD
$V_{IN} \geq V_{UVLO_1,2(IN)}$	$V_{BIAS} \geq V_{UVLO(BIAS)}$	EN = 1	On	Off	PG = 1 when $V_{OUT} \geq V_{IT(PG)}$
		EN = 0	Off	On	
$V_{IN} < V_{UVLO_1,2(IN)} - V_{HYS1,2(IN)}$	BIAS = don't care	EN = don't care	Off	On ⁽¹⁾	PG = 0
			Off		
IN = don't care	$V_{BIAS} \geq V_{UVLO(BIAS)}$		Off		

(1) The active discharge remains on as long as V_{IN} or V_{BIAS} provides enough headroom for the discharge circuit to function.

7.3.2.2.1 Enable (EN)

The enable signal (V_{EN}) is an active-high digital control that enables the LDO when the enable voltage is past the rising threshold ($V_{EN} \geq V_{IH(EN)}$) and disables the LDO when the enable voltage is below the falling threshold ($V_{EN} \leq V_{IL(EN)}$). The exact enable threshold is between $V_{IH(EN)}$ and $V_{IL(EN)}$ because EN is a digital control. Connect EN to V_{IN} if enable functionality is not desired.

7.3.2.2.2 Undervoltage Lockout (UVLO) Control

The UVLO circuits respond quickly to glitches on IN or BIAS and attempts to disable the output of the device if either of these rails collapse.

7.3.2.2.3 Active Discharge

When either EN or UVLO is low, the device connects a resistor of several hundred ohms from V_{OUT} to GND, discharging the output capacitance.

Do not rely on the active discharge circuit for discharging large output capacitors when the input voltage drops below the targeted output voltage. Current flows from the output to the input (reverse current) when $V_{OUT} > V_{IN}$, which can cause damage to the device (when $V_{OUT} > V_{IN} + 0.3$ V).

7.3.2.3 Power-Good Output (PG)

The PG signal provides an easy solution to meet demanding sequencing requirements because PG signals when the output nears its nominal value. PG can be used to signal other devices in a system when the output voltage is near, at, or above the set output voltage ($V_{OUT(nom)}$). Figure 42 shows a simplified schematic.

The PG signal is an open-drain digital output that requires a pullup resistor to a voltage source and is active high. The PG circuit sets the PG pin into a high-impedance state to indicate that the power is good.

Using a large feed-forward capacitor (C_{FF}) delays the output voltage and, because the PG circuit monitors the FB pin, the PG signal can indicate a false positive.

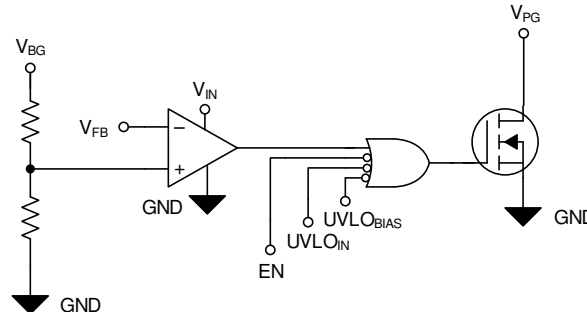

Figure 42. Simplified PG Circuit

7.3.3 Internal Protection Features

In many applications, fault events can occur that damage devices in the system. Short circuits and excessive heat are the most common fault events for power supplies. The TPS7A52-Q1 implements circuitry to protect the device and its load during these events. Continuously operating in these fault conditions or above a junction temperature of 140°C is not recommended because the long-term reliability of the device is reduced.

7.3.3.1 Foldback Current Limit (I_{CL})

The internal current limit circuit is used to protect the LDO against high load-current faults or shorting events. During a current-limit event, the LDO sources constant current; therefore, the output voltage falls with decreased load impedance. Thermal shutdown can activate during a current limit event because of the high power dissipation typically found in these conditions. For proper operation of the current limit, minimize the inductances to the input and load. Continuous operation in current limit is not recommended.

7.3.3.2 Thermal Protection (T_{sd})

The thermal shutdown circuit protects the LDO against excessive heat in the system, either resulting from current limit or high ambient temperature.

The output of the LDO turns off when the LDO temperature (junction temperature, T_J) exceeds the rising thermal shutdown temperature. The output turns on again after T_J decreases below the falling thermal shutdown temperature.

A high power dissipation across the device, combined with a high ambient temperature (T_A), can cause T_J to be greater than or equal to T_{sd} , triggering the thermal shutdown and causing the output to fall to 0 V. The LDO can cycle on and off when thermal shutdown is reached under these conditions.

7.4 Device Functional Modes

Table 3 provides a quick comparison between the regulation and disabled operation.

Table 3. Device Functional Modes Comparison

OPERATING MODE	PARAMETER				
	V_{IN}	V_{BIAS}	EN	I_{OUT}	T_J
Regulation ⁽¹⁾	$V_{IN} > V_{OUT(nom)} + V_{DO}$	$V_{BIAS} \geq V_{UVLO(BIAS)}$ ⁽²⁾	$V_{EN} > V_{IH(EN)}$	$I_{OUT} < I_{CL}$	$T_J \leq T_{J(maximum)}$
Disabled ⁽³⁾	$V_{IN} < V_{UVLO_1,2(IN)}$	$V_{BIAS} < V_{UVLO(BIAS)}$	$V_{EN} < V_{IL(EN)}$	—	$T_J > T_{sd}$

(1) All table conditions must be met.

(2) V_{BIAS} is only required for $V_{IN} < 1.4$ V.

(3) The device is disabled when any condition is met.

7.4.1 Regulation

The device regulates the output to the nominal output voltage when all the conditions in Table 3 are met.

7.4.2 Disabled

When disabled, the pass device is turned off, the internal circuits are shut down, and the output voltage is actively discharged to ground by an internal resistor from the output to ground. See the [Active Discharge](#) section for additional information.

7.4.3 Current Limit Operation

During a current-limit event, the LDO regulates the output current instead of the output voltage; therefore, the output voltage falls with decreased load impedance.

8 Application and Implementation

NOTE

Information in the following applications sections is not part of the TI component specification, and TI does not warrant its accuracy or completeness. TI's customers are responsible for determining suitability of components for their purposes. Customers should validate and test their design implementation to confirm system functionality.

8.1 Application Information

Successfully implementing an LDO in an application depends on the application requirements. This section discusses key device features and how to best implement them to achieve a reliable design.

8.1.1 Recommended Capacitor Types

The TPS7A52-Q1 is designed to be stable using low equivalent series resistance (ESR) ceramic capacitors at the input, output, and noise-reduction pin (NR, pin 13). Multilayer ceramic capacitors have become the industry standard for these types of applications and are recommended, but must be used with good judgment. Ceramic capacitors that employ X7R-, X5R-, and COG-rated dielectric materials provide relatively good capacitive stability across temperature. The use of Y5V-rated capacitors is discouraged because of large variations in capacitance.

Regardless of the ceramic capacitor type selected, ceramic capacitance varies with operating voltage and temperature. Make sure to derate ceramic capacitors by at least 50%. The input and output capacitors recommended herein account for a capacitance derating of approximately 50%, but at high V_{IN} and V_{OUT} conditions ($V_{IN} = 5.5$ V to $V_{OUT} = 5.0$ V), the derating can be greater than 50%, and must be taken into consideration.

8.1.1.1 Input and Output Capacitor Requirements (C_{IN} and C_{OUT})

The TPS7A52-Q1 is designed and characterized for operation with ceramic capacitors of 22 μ F or greater (10 μ F or greater of capacitance) at the output and 10 μ F or greater (5 μ F or greater of capacitance) at the input. Use at least a 22- μ F capacitor at the input to minimize input impedance. Place the input and output capacitors as near as practical to the respective input and output pins in order to minimize trace parasitics. If the trace inductance from the input supply to the TPS7A52-Q1 is high, a fast current transient can cause V_{IN} to ring above the absolute maximum voltage rating and damage the device. This situation can be mitigated by additional input capacitors to dampen and keep the ringing below the device absolute maximum ratings.

Application Information (continued)

8.1.1.2 Noise-Reduction and Soft-Start Capacitor ($C_{NR/SS}$)

The TPS7A52-Q1 features a programmable, monotonic, voltage-controlled soft start that is set with an external capacitor ($C_{NR/SS}$). Use an external $C_{NR/SS}$ to minimize inrush current into the output capacitors. This soft-start feature eliminates power-up initialization problems when powering field-programmable gate arrays (FPGAs), digital signal processors (DSPs), or other processors. The controlled voltage ramp of the output also reduces peak inrush current during start-up, minimizing start-up transients to the input power bus.

To achieve a monotonic start-up, the TPS7A52-Q1 error amplifier tracks the voltage ramp of the external soft-start capacitor until the voltage approaches the internal reference. The soft-start ramp time depends on the soft-start charging current ($I_{NR/SS}$), the soft-start capacitance ($C_{NR/SS}$), and the internal reference ($V_{NR/SS}$). Equation 1 calculates soft-start ramp time:

$$t_{SS} = (V_{NR/SS} \times C_{NR/SS}) / I_{NR/SS} \quad (1)$$

$I_{NR/SS}$ is provided in the [Electrical Characteristics](#) table and has a typical value of 6.2 μ A.

The noise-reduction capacitor, in conjunction with the noise-reduction resistor, forms a low-pass filter (LPF) that filters out the noise from the reference before being gained up with the error amplifier, thereby reducing the device noise floor. The LPF is a single-pole filter and Equation 2 calculates the cutoff frequency. The typical value of R_{NR} is 250 k Ω . Increasing the $C_{NR/SS}$ capacitor has a greater affect because the output voltage increases when the noise from the reference is gained up even more at higher output voltages. For low-noise applications, a 10-nF to 1- μ F $C_{NR/SS}$ is recommended.

$$f_{cutoff} = 1 / (2 \times \pi \times R_{NR} \times C_{NR/SS}) \quad (2)$$

8.1.1.3 Feed-Forward Capacitor (C_{FF})

Although a feed-forward capacitor (C_{FF}) from the FB pin to the OUT pin is not required to achieve stability, a 10-nF external feed-forward capacitor optimizes the transient, noise, and PSRR performance. A higher capacitance C_{FF} can be used; however, the start-up time is longer and the power-good signal can incorrectly indicate that the output voltage is settled. For a detailed description, see [Pros and Cons of Using a Feed-Forward Capacitor with a Low Dropout Regulator](#).

8.1.2 Soft-Start and Inrush Current

Soft start refers to the ramp-up characteristic of the output voltage during LDO turnon after EN and UVLO achieve threshold voltage. The noise-reduction capacitor serves a dual purpose of both governing output noise reduction and programming the soft-start ramp during turnon.

Inrush current is defined as the current into the LDO at the IN pin during start-up. Inrush current then consists primarily of the sum of load current and the current used to charge the output capacitor. This current is difficult to measure because the input capacitor must be removed, which is not recommended. However, Equation 3 can be used to estimate this soft-start current:

$$I_{OUT(t)} = \left[\frac{C_{OUT} \times dV_{OUT}(t)}{dt} \right] + \left[\frac{V_{OUT}(t)}{R_{LOAD}} \right]$$

where:

- $V_{OUT}(t)$ is the instantaneous output voltage of the turnon ramp
- $dV_{OUT}(t) / dt$ is the slope of the V_{OUT} ramp
- R_{LOAD} is the resistive load impedance

(3)

Application Information (continued)

8.1.3 Optimizing Noise and PSRR

Improve the ultra-low noise floor and PSRR of the device by careful selection of:

- $C_{NR/SS}$ for the low-frequency range
- C_{FF} in the midband frequency range
- C_{OUT} for the high-frequency range
- $V_{IN} - V_{OUT}$ for all frequencies, and
- V_{BIAS} at lower input voltages

A larger noise-reduction capacitor improves low-frequency PSRR by filtering any noise coupling from the input into the reference. To improve midband PSRR, use the feed-forward capacitor to place pole-zero pair near the edge of the loop bandwidth and push out the loop bandwidth. Use larger output capacitors to improve high-frequency PSRR.

A higher input voltage improves the PSRR by giving the device more headroom to respond to noise on the input. A bias rail also improves PSRR at lower input voltages because greater headroom is provided for the internal circuits.

The noise-reduction capacitor filters out low-frequency noise from the reference, and the feed-forward capacitor reduces output voltage noise by filtering out the midband frequency noise. However, a large feed-forward capacitor can create new issues that are discussed in [Pros and Cons of Using a Feed-Forward Capacitor with a Low Dropout Regulator](#).

Use a large output capacitor to reduce high-frequency output voltage noise. Additionally, a bias rail or higher input voltage improves the noise because greater headroom is provided for the internal circuits.

[Table 4](#) lists the output voltage noise for the 10-Hz to 100-kHz band at a 5.0-V output for a variety of conditions with an input voltage of 5.5 V, an R_1 of 12.1 k Ω , and a load current of 2 A. The 5.0-V output was used because this output is the worst-case condition for output voltage noise.

Table 4. Output Noise Voltage at a 5.0-V Output

OUTPUT VOLTAGE NOISE (μV_{RMS})	$C_{NR/SS}$ (nF)	C_{FF} (nF)	C_{OUT} (μF)
11.7	10	10	22
7.7	100	10	22
6	100	100	22
7.4	100	10	1000
5.8	100	100	1000

8.1.4 Charge Pump Noise

The device internal charge pump generates a minimal amount of noise. Use a bias rail to minimize the internal charge pump noise when the internal voltage is clamped, thereby reducing the overall output noise floor.

The high-frequency components of the output voltage noise density curves are filtered out in most applications by using 10-nF to 100-nF bypass capacitors close to the load. Using a ferrite bead between the LDO output and the load input capacitors forms a pi-filter, further reducing the high-frequency noise contribution.

8.1.5 Current Sharing

Current sharing is possible through the use of external operational amplifiers. For more details, see the TI Design [Current-Sharing Dual LDOs](#) and the verified reference design [6 A Current-Sharing Dual LDO](#).

8.1.6 Adjustable Operation

As shown in Figure 43, the output voltage of the TPS7A52-Q1 is set using external resistors.

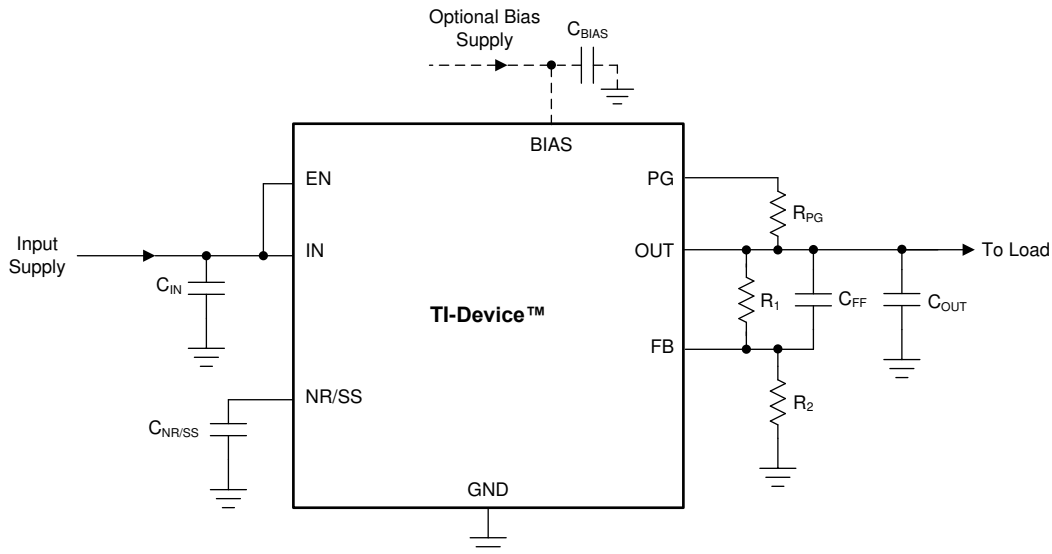

Figure 43. Adjustable Operation

Use Equation 4 to calculate R_1 and R_2 for any output voltage range. This resistive network must provide a current equal to or greater than $5 \mu\text{A}$ for dc accuracy. To optimize the noise and PSRR, use an R_1 of $12.1 \text{ k}\Omega$.

$$V_{\text{OUT}} = V_{\text{NR/SS}} \times (1 + R_1 / R_2) \quad (4)$$

Table 5 shows the resistor combinations required to achieve several common rails using standard 1%-tolerance resistors.

Table 5. Recommended Feedback-Resistor Values

TARGETED OUTPUT VOLTAGE (V)	FEEDBACK RESISTOR VALUES ⁽¹⁾		CALCULATED OUTPUT VOLTAGE (V)
	R_1 (k Ω)	R_2 (k Ω)	
0.9	12.4	100	0.899
0.95	12.4	66.5	0.949
1.00	12.4	49.9	0.999
1.10	12.4	33.2	1.099
1.20	12.4	24.9	1.198
1.50	12.4	14.3	1.494
1.80	12.4	10	1.798
1.90	12.1	8.87	1.89
2.50	12.4	5.9	2.48
2.85	12.1	4.75	2.838
3.00	12.1	4.42	2.990
3.30	11.8	3.74	3.324
3.60	12.1	3.48	3.582
4.5	11.8	2.55	4.502
5.00	12.4	2.37	4.985

(1) R_1 is connected from OUT to FB; R_2 is connected from FB to GND.

8.1.7 Power-Good Operation

For proper operation of the power-good circuit, the pullup resistor value must be between 10 k Ω and 100 k Ω . The lower limit of 10 k Ω results from the maximum pulldown strength of the power-good transistor, and the upper limit of 100 k Ω results from the maximum leakage current at the power-good node. If the pullup resistor is outside of this range, then the power-good signal may not read a valid digital logic level.

Using a large C_{FF} with a small $C_{NR/SS}$ causes the power-good signal to incorrectly indicate that the output voltage has settled during turnon. The C_{FF} time constant must be greater than the soft-start time constant for proper operation of the PG during start-up. For a detailed description, see [Pros and Cons of Using a Feed-Forward Capacitor with a Low Dropout Regulator](#).

The state of PG is only valid when the device operates above the minimum supply voltage. During short UVLO events and at light loads, power-good does not assert because the output voltage is sustained by the output capacitance.

8.1.8 Undervoltage Lockout (UVLO) Operation

The UVLO circuit makes sure that the device remains disabled before the input or bias supplies reach the minimum operational voltage range, and that the device shuts down when the input supply or bias supply falls too low.

The UVLO circuit has a minimum response time of several microseconds to fully assert. During this time, a downward line transient below approximately 0.8 V causes the UVLO to assert for a short time; however, the UVLO circuit does not have enough stored energy to fully discharge the internal circuits inside of the device. When the UVLO circuit does not fully discharge, the internal circuits of the output are not fully disabled.

The effect of the downward line transient can be mitigated by either using a larger input capacitor to limit the fall time of the input supply when operating near the minimum V_{IN} , or by using a bias rail.

Figure 44 shows the UVLO circuit response to various input voltage events. The diagram can be separated into the following regions:

- Region A: The device does not turn on until the input reaches the UVLO rising threshold.
- Region B: Normal operation with a regulated output
- Region C: Brownout event above the UVLO falling threshold (UVLO rising threshold – UVLO hysteresis). The output may fall out of regulation but the device is still enabled.
- Region D: Normal operation with a regulated output
- Region E: Brownout event below the UVLO falling threshold. The device is disabled in most cases and the output falls because of the load and active discharge circuit. The device is reenabled when the UVLO rising threshold is reached by the input voltage and a normal start-up then follows.
- Region F: Normal operation followed by the input falling to the UVLO falling threshold.
- Region G: The device is disabled when the input voltage falls below the UVLO falling threshold to 0 V. The output falls because of the load and active discharge circuit.

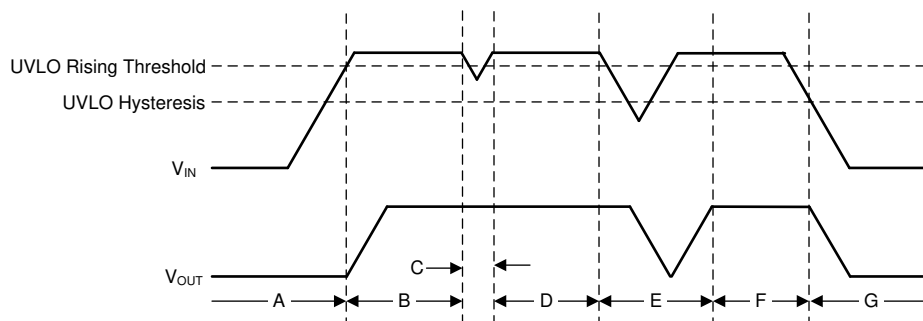

Figure 44. Typical UVLO Operation

8.1.9 Dropout Voltage (V_{DO})

Generally speaking, the dropout voltage often refers to the minimum voltage difference between the input and output voltage ($V_{DO} = V_{IN} - V_{OUT}$) that is required for regulation. When V_{IN} drops below the required V_{DO} for the given load current, the device functions as a resistive switch and does not regulate output voltage. Dropout voltage is proportional to the output current because the device is operating as a resistive switch.

Dropout voltage is affected by the drive strength for the gate of the pass element, which is nonlinear with respect to V_{IN} on this device because of the internal charge pump. The charge pump causes a higher dropout voltage at lower input voltages when a bias rail is not used.

For this device, dropout voltage increases exponentially when the input voltage nears its maximum operating voltage because the charge pump is internally clamped to 8.0 V.

8.1.10 Load Transient Response

The load-step transient response is the output voltage response by the LDO to a step in load current, whereby output voltage regulation is maintained. There are two key transitions during a load transient response: the transition from a light to a heavy load, and the transition from a heavy to a light load. The regions shown in [Figure 45](#) are broken down in this section. Regions A, E, and H are where the output voltage is in steady-state regulation.

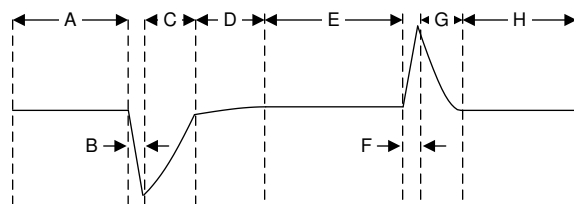

Figure 45. Load Transient Waveform

During transitions from a light load to a heavy load:

- Initial voltage dip is a result of the depletion of the output capacitor charge and parasitic impedance to the output capacitor (region B).
- Recovery from the dip results from the LDO increasing its sourcing current, and leads to output voltage regulation (region C).

During transitions from a heavy load to a light load:

- Initial voltage rise results from the LDO sourcing a large current, and leads to the output capacitor charge to increase (region F).
- Recovery from the rise results from the LDO decreasing its sourcing current in combination with the load discharging the output capacitor (region G).

Transitions between current levels changes the internal power dissipation because the TPS7A52-Q1 is a high-current device (region D). The change in power dissipation changes the die temperature during these transitions, and leads to a slightly different voltage level. This different output voltage level shows up in the various load transient responses.

A larger output capacitance reduces the peaks during a load transient but slows down the response time of the device. A larger dc load also reduces the peaks because the amplitude of the transition is lowered and a higher current discharge path is provided for the output capacitor.

8.1.11 Reverse Current Protection Considerations

As with most LDOs, this device can be damaged by excessive reverse current.

Conditions where excessive reverse current can occur are outlined in this section, all of which can exceed the absolute maximum rating of $V_{OUT} > V_{IN} + 0.3\text{ V}$:

- If the device has a large C_{OUT} , then the input supply collapses quickly and the load current becomes very small
- The output is biased when the input supply is not established
- The output is biased above the input supply

If an excessive reverse current flow is expected in the application, then external protection must be used to protect the device. [Figure 46](#) shows one approach of protecting the device.

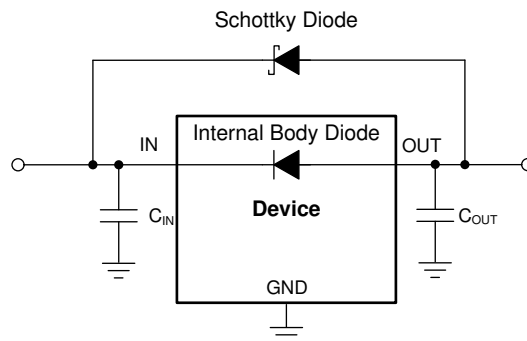

Figure 46. Example Circuit for Reverse Current Protection Using a Schottky Diode

8.1.12 Power Dissipation (P_D)

Circuit reliability demands that proper consideration be given to device power dissipation, location of the circuit on the printed circuit board (PCB), and correct sizing of the thermal plane. The PCB area around the regulator must be as free as possible of other heat-generating devices that cause added thermal stresses.

As a first-order approximation, power dissipation in the regulator depends on the input-to-output voltage difference and load conditions. Use [Equation 5](#) to calculate P_D :

$$P_D = (V_{OUT} - V_{IN}) \times I_{OUT} \quad (5)$$

NOTE

Power dissipation can be minimized, and thus greater efficiency achieved, by proper selection of the system voltage rails. Proper selection allows the minimum input-to-output voltage differential to be obtained. The low dropout of the TPS7A52-Q1 allows for maximum efficiency across a wide range of output voltages.

The primary heat conduction path for the package is through the thermal pad to the PCB. Solder the thermal pad to a copper pad area under the device. This pad area contains an array of plated vias that conduct heat to any inner plane areas or to a bottom-side copper plane.

The maximum power dissipation determines the maximum allowable junction temperature (T_J) for the device. Power dissipation and junction temperature are most often related by the junction-to-ambient thermal resistance ($R_{\theta JA}$) of the combined PCB and device package and the temperature of the ambient air (T_A), according to [Equation 6](#). The equation is rearranged for output current in [Equation 7](#).

$$T_J = T_A + (R_{\theta JA} \times P_D) \quad (6)$$

$$I_{OUT} = (T_J - T_A) / [R_{\theta JA} \times (V_{IN} - V_{OUT})] \quad (7)$$

Unfortunately, this thermal resistance ($R_{\theta JA}$) is highly dependent on the heat-spreading capability built into the particular PCB design, and therefore varies according to the total copper area, copper weight, and location of the planes. The $R_{\theta JA}$ recorded in the [Electrical Characteristics](#) table is determined by the JEDEC standard, PCB, and copper-spreading area, and is only used as a relative measure of package thermal performance. For a well-designed thermal layout, $R_{\theta JA}$ is actually the sum of the VQFN package junction-to-case (bottom) thermal resistance ($R_{\theta JC(bot)}$) plus the thermal resistance contribution by the PCB copper.

8.1.13 Estimating Junction Temperature

The JEDEC standard now recommends the use of psi (Ψ) thermal metrics to estimate the junction temperatures of the LDO when in-circuit on a typical PCB board application. These metrics are not strictly speaking thermal resistances, but rather offer practical and relative means of estimating junction temperatures. These psi metrics are determined to be significantly independent of the copper-spreading area. The key thermal metrics (Ψ_{JT} and Ψ_{JB}) are used in accordance with [Equation 8](#) and are given in the [Electrical Characteristics](#) table.

$$\Psi_{JT}: T_J = T_T + \Psi_{JT} \times P_D$$

$$\Psi_{JB}: T_J = T_B + \Psi_{JB} \times P_D$$

where:

- P_D is the power dissipated as explained in [Equation 5](#)
 - T_T is the temperature at the center-top of the device package, and
 - T_B is the PCB surface temperature measured 1 mm from the device package and centered on the package edge
- (8)

8.2 Typical Application

This section discusses the implementation of the TPS7A52-Q1 using an adjustable feedback network to regulate a 2-A load requiring good PSRR at high frequency with low-noise at an output voltage of 5.0 V. Figure 47 provides a schematic for this typical application circuit.

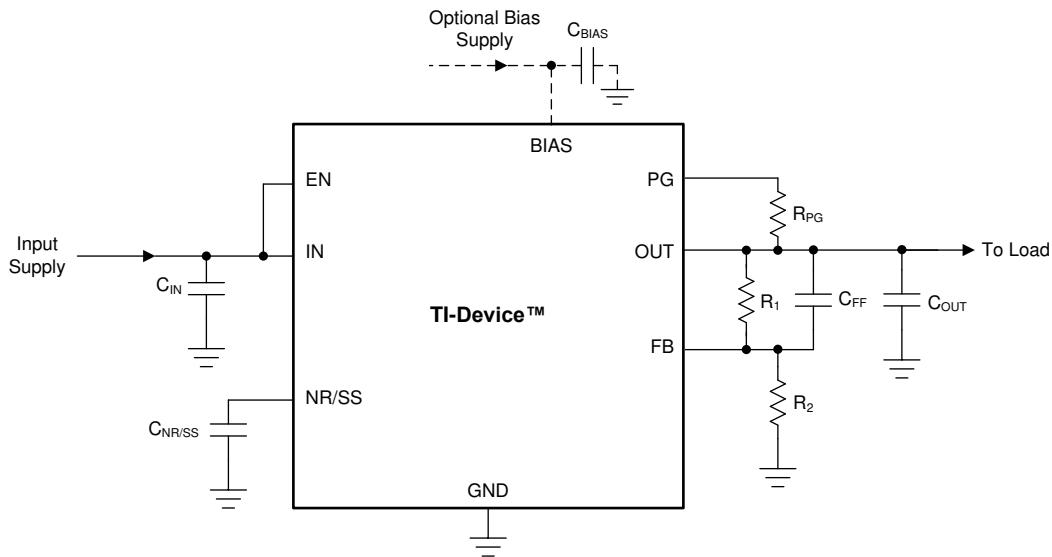

Figure 47. Typical Application for a 5.0-V Rail

8.2.1 Design Requirements

For this design example, use the parameters listed in Table 6 as the input parameters.

Table 6. Design Parameters

PARAMETER	DESIGN REQUIREMENT
Input voltage	5.50 V, ±1%, provided by the dc/dc converter switching at 500 kHz
Bias voltage	Not used because $V_{OUT} \geq 2.20$ V
Output voltage	5.0 V, ±1%
Output current	2.0 A (maximum), 10 mA (minimum)
RMS noise, 10 Hz to 100 kHz	< 10 μ V _{RMS}
PSRR at 500 kHz	> 40 dB
Start-up time	< 25 ms

8.2.2 Detailed Design Procedure

At 2.0 A and 5.0 V_{OUT} , the dropout of the TPS7A52-Q1 has a 200-mV maximum dropout over temperature; thus, a 500-mV headroom is sufficient for operation over both input and output voltage accuracy. At full load and high temperature on some devices, the TPS7A52-Q1 can enter dropout if both the input and output supply are beyond the edges of the respective accuracy specification.

For a 5.0-V output, use external adjustable resistors. See the resistor values in listed Table 5 for choosing resistors for a 5.0-V output.

Input and output capacitors are selected in accordance with the [Recommended Capacitor Types](#) section. Ceramic capacitances of 10 μ F for the input and 22 μ F for the output are selected.

To satisfy the required start-up time and still maintain low noise performance, a 100-nF $C_{NR/SS}$ is selected. Use Equation 9 to calculate this value.

$$t_{SS} = (V_{NR/SS} \times C_{NR/SS}) / I_{NR/SS} \tag{9}$$

At the 2.0-A maximum load, the internal power dissipation is 1.0 W and corresponds to a 43.4°C junction temperature rise for the RGR package on a standard JEDEC board. With an 55°C maximum ambient temperature, the junction temperature is at 98.4°C. To further minimize noise, a feed-forward capacitance (C_{FF}) of 10 nF is selected.

8.2.3 Application Curves

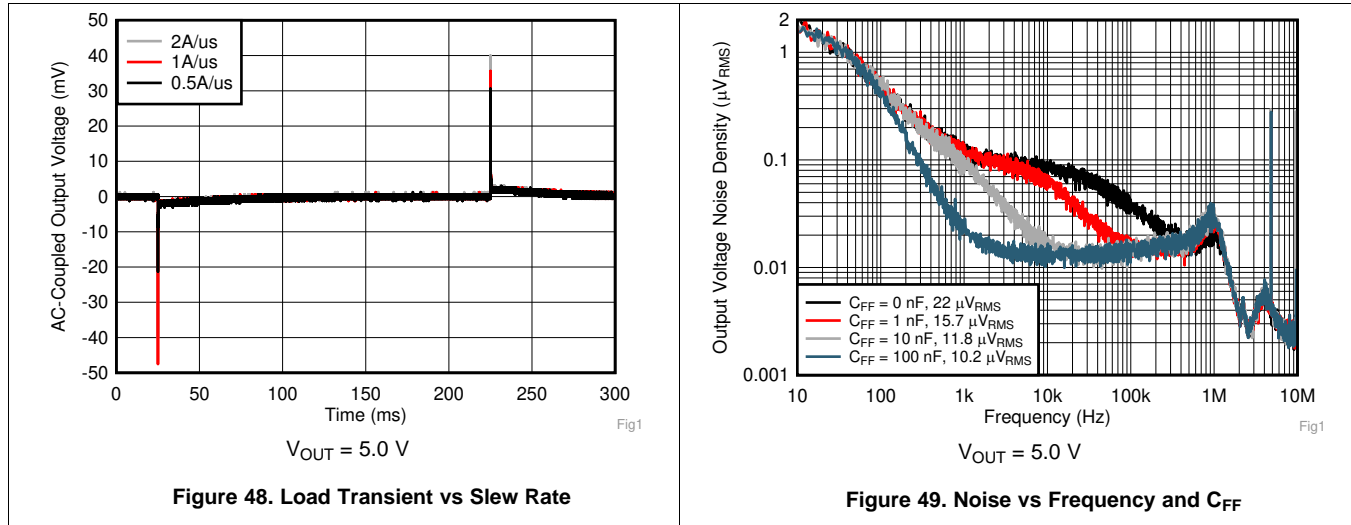

9 Power Supply Recommendations

The TPS7A52-Q1 is designed to operate from an input voltage supply range between 1.1 V and 6.5 V. If the input supply is less than 1.4 V, then a bias rail of at least 3.0 V must be used. The input voltage range provides adequate headroom in order for the device to have a regulated output. This input supply must be well regulated. If the input supply is noisy, use additional input capacitors with low ESR to help improve output noise performance.

10 Layout

10.1 Layout Guidelines

10.1.1 Board Layout

For best overall performance, place all circuit components on the same side of the circuit board and as near as practical to the respective LDO pin connections. Place ground return connections to the input and output capacitor, and to the LDO ground pin as close to each other as possible, connected by a wide, component-side, copper surface. To avoid negative system performance, do not use of vias and long traces to the input and output capacitors. The grounding and layout scheme provided in [Figure 50](#) minimizes inductive parasitics, and thereby reduces load-current transients, minimizes noise, and increases circuit stability.

To improve performance, use a ground reference plane, either embedded in the PCB itself or placed on the bottom side of the PCB opposite the components. This reference plane serves to assure accuracy of the output voltage, shield noise, and behaves similar to a thermal plane to spread (or sink) heat from the LDO device when connected to the thermal pad. In most applications, this ground plane is necessary to meet thermal requirements.

10.1.2 RTK Package—High CTE Mold Compound

The RTK package uses a mold compound with a high coefficient of thermal expansion (CTE) of 12 ppm/°C. This mold compound allows for the CTE of the packaged IC to more closely match the CTE of a conventional FR4 PCB (~14 ppm/°C to 17 ppm/°C). This CTE match is important when considering the effects that temperature swings can induce on a board with large differences in CTE values. Package and board combinations with widely dissimilar CTEs can experience mechanical cracking or fracturing of the solder joints caused by frequent changes in temperature and the corresponding differences in expansion. Devices with normal mold compounds in similar packages typically have CTE values that are 25% lower than values found with the RTK package.

10.2 Layout Example

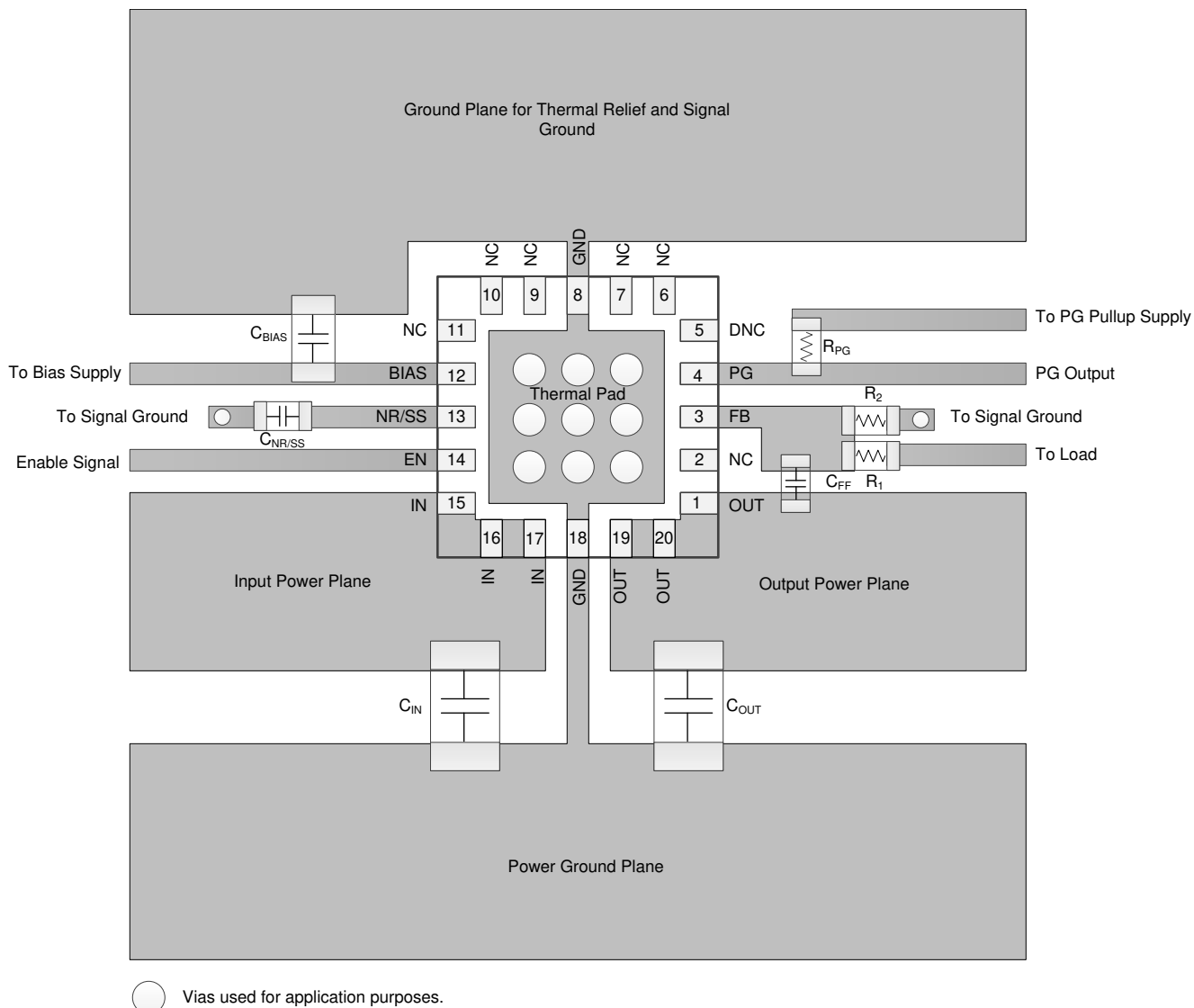

Figure 50. Example Layout

11 Device and Documentation Support

11.1 Device Support

11.1.1 Development Support

11.1.1.1 Evaluation Modules

An evaluation module (EVM) is available to assist in the initial circuit performance evaluation using the TPS7A52. The summary information for this fixture is shown in [Table 7](#). The EVM can be requested through the [TPS7A52 product folder](#).

Table 7. Evaluation Module

DEVICE	LITERATURE NUMBER
TPS7A52EVM-002 evaluation module	SBVU042

11.1.1.2 Reference Designs

For related TI reference designs, see the following:

[TI Design - Current-Sharing Dual LDOs \(TIDA-00270\)](#)

11.1.1.3 Spice Models

Computer simulation of circuit performance using SPICE is often useful when analyzing the performance of analog circuits and systems. Models for the TPS7A52 are available through the [TPS7A52 product folder](#) under Tools and Software → Models.

11.1.2 Device Nomenclature

Table 8. Ordering Information⁽¹⁾

PRODUCT	DESCRIPTION
TPS7A5201QYYYY Z	YYY is the package designator. Z is the package quantity.

(1) For the most current package and ordering information see the Package Option Addendum at the end of this document, or see the device product folder at www.ti.com.

11.2 Documentation Support

11.2.1 Related Documentation

For related documentation, see the following:

- Texas Instruments, [TPS3702 High-Accuracy, Overvoltage and Undervoltage Monitor Data Sheet](#)
- Texas Instruments, [TPS7A52-Q1 Automotive 2A High-Accuracy Low-Noise LDO Voltage Regulator Evaluation Module](#)
- Texas Instruments, [Pros and Cons of Using a Feed-Forward Capacitor with a Low Dropout Regulator Application Report](#)
- Texas Instruments, [6 A Current-Sharing Dual LDO User's Guide](#)

11.3 Receiving Notification of Documentation Updates

To receive notification of documentation updates, navigate to the device product folder on ti.com. In the upper right corner, click on *Alert me* to register and receive a weekly digest of any product information that has changed. For change details, review the revision history included in any revised document.

11.4 Support Resources

[TI E2E™ support forums](#) are an engineer's go-to source for fast, verified answers and design help — straight from the experts. Search existing answers or ask your own question to get the quick design help you need.

Linked content is provided "AS IS" by the respective contributors. They do not constitute TI specifications and do not necessarily reflect TI's views; see TI's [Terms of Use](#).

11.5 Trademarks

E2E is a trademark of Texas Instruments.

All other trademarks are the property of their respective owners.

11.6 Electrostatic Discharge Caution



This integrated circuit can be damaged by ESD. Texas Instruments recommends that all integrated circuits be handled with appropriate precautions. Failure to observe proper handling and installation procedures can cause damage.

ESD damage can range from subtle performance degradation to complete device failure. Precision integrated circuits may be more susceptible to damage because very small parametric changes could cause the device not to meet its published specifications.

11.7 Glossary

[SLYZ022](#) — *TI Glossary*.

This glossary lists and explains terms, acronyms, and definitions.

12 Mechanical, Packaging, and Orderable Information

The following pages include mechanical, packaging, and orderable information. This information is the most current data available for the designated devices. This data is subject to change without notice and revision of this document. For browser-based versions of this data sheet, refer to the left-hand navigation.



RTK0020C

PACKAGE OUTLINE
VQFN - 0.9 mm max height

PLASTIC QUAD FLATPACK - NO LEAD

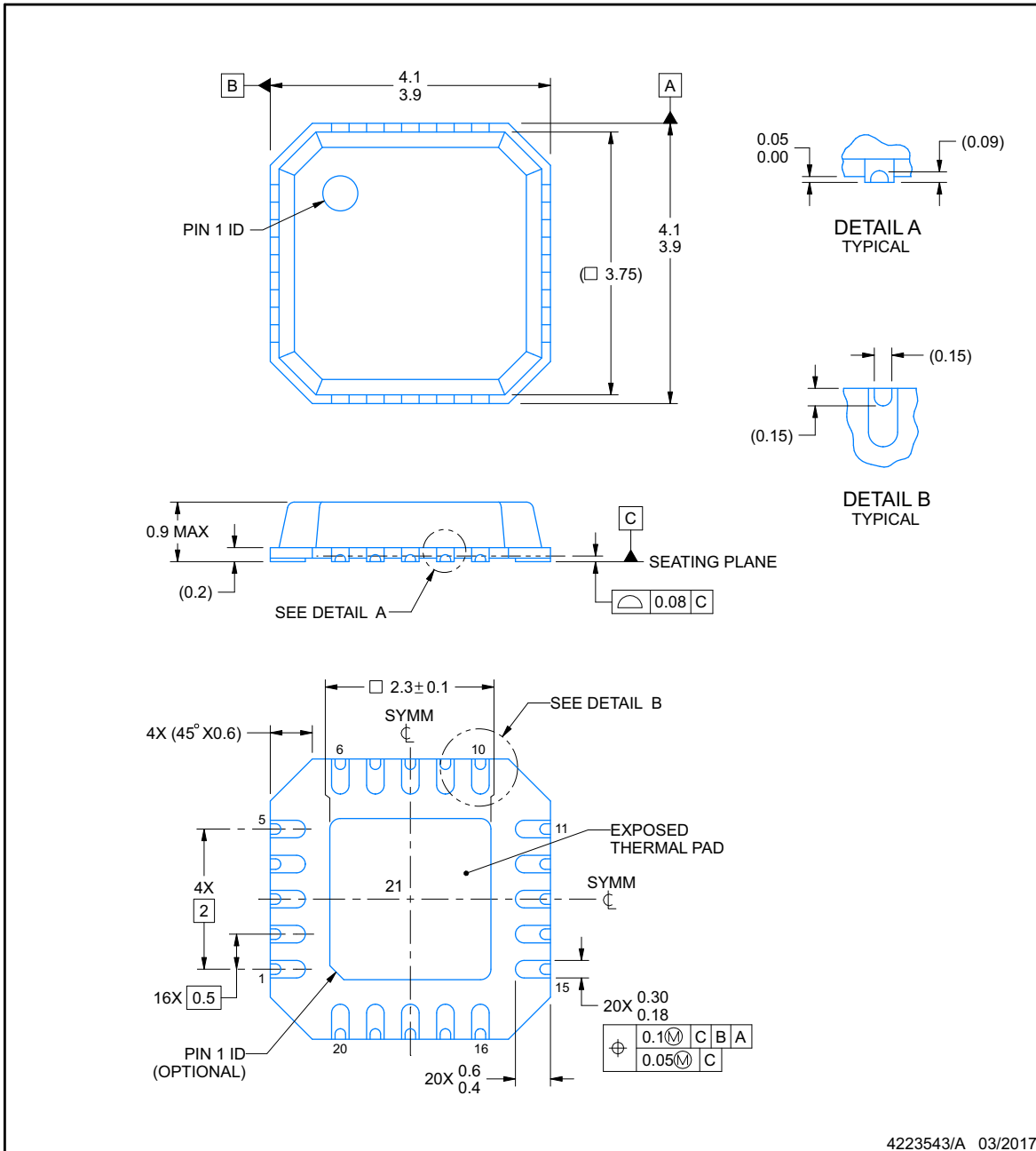

NOTES:

1. All linear dimensions are in millimeters. Any dimensions in parenthesis are for reference only. Dimensioning and tolerancing per ASME Y14.5M.
2. This drawing is subject to change without notice.
3. The package thermal pad must be soldered to the printed circuit board for thermal and mechanical performance.

EXAMPLE BOARD LAYOUT

RTK0020C

VQFN - 0.9 mm max height

PLASTIC QUAD FLATPACK - NO LEAD

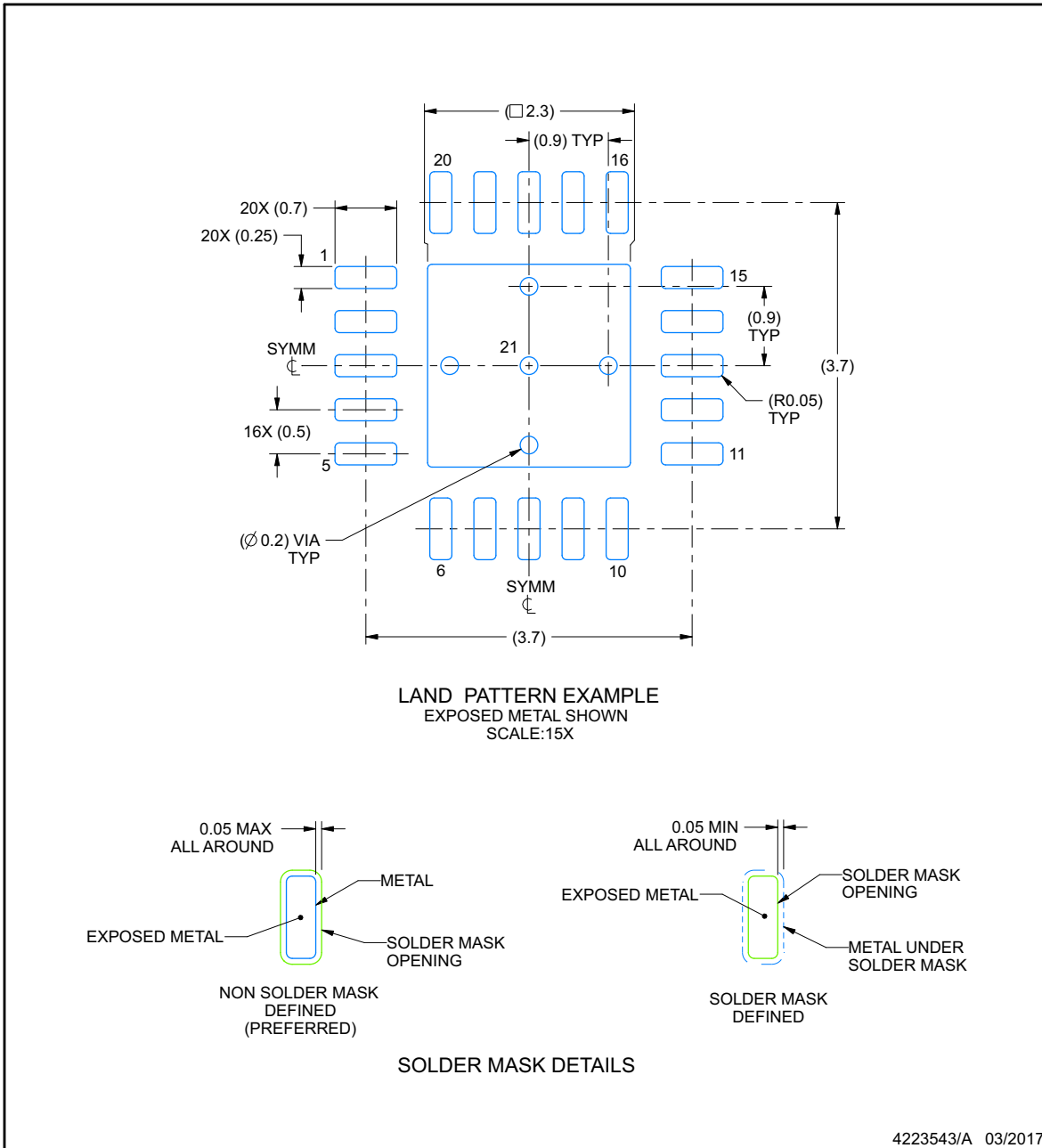

NOTES: (continued)

4. This package is designed to be soldered to a thermal pad on the board. For more information, see Texas Instruments literature number SLUA271 (www.ti.com/lit/slue271).
5. Vias are optional depending on application, refer to device data sheet. If any vias are implemented, refer to their locations shown on this view. It is recommended that vias under paste be filled, plugged or tented.

EXAMPLE STENCIL DESIGN

RTK0020C

VQFN - 0.9 mm max height

PLASTIC QUAD FLATPACK - NO LEAD

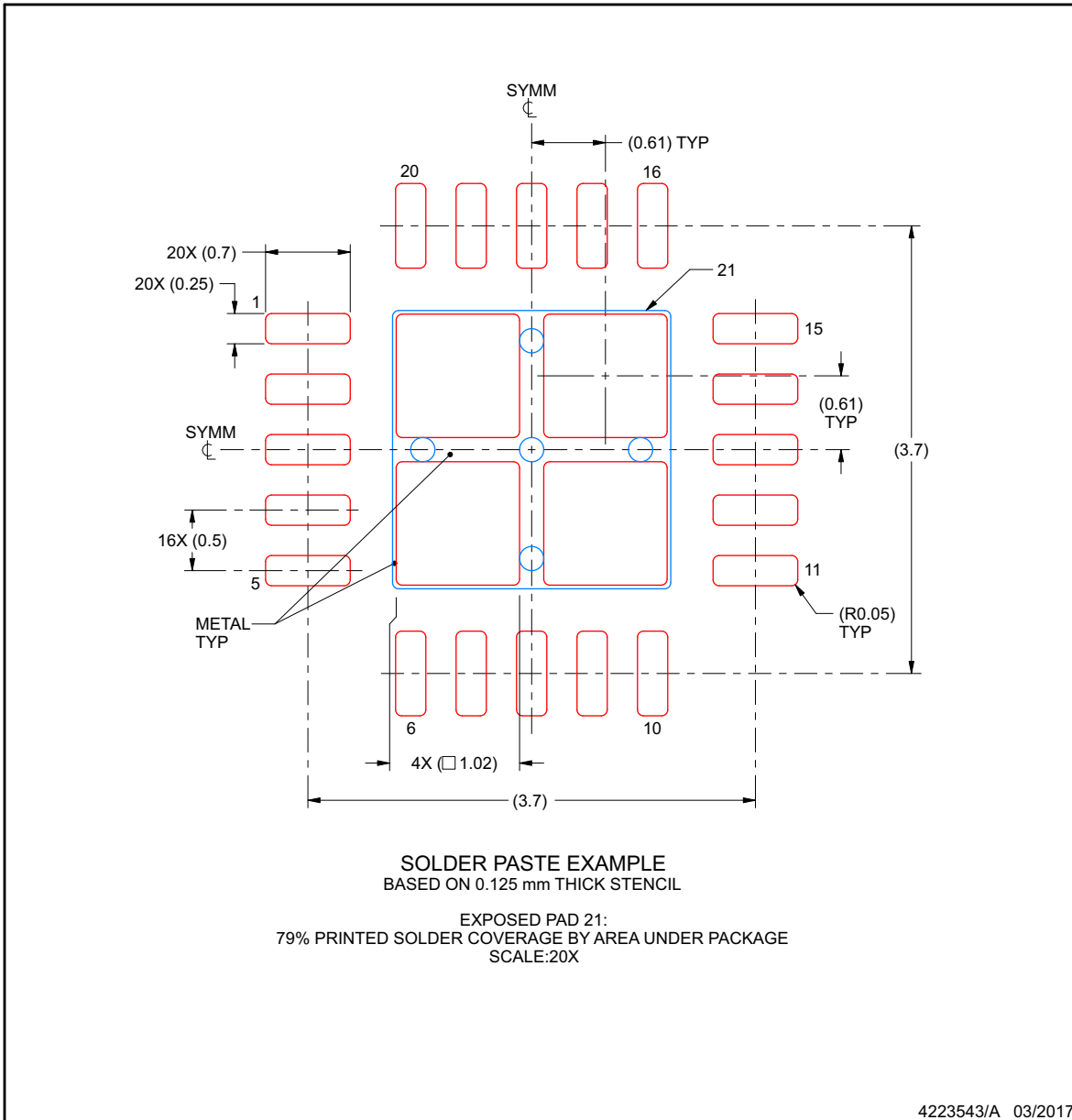

NOTES: (continued)

- 6. Laser cutting apertures with trapezoidal walls and rounded corners may offer better paste release. IPC-7525 may have alternate design recommendations.

PACKAGING INFORMATION

Orderable Device	Status (1)	Package Type	Package Drawing	Pins	Package Qty	Eco Plan (2)	Lead finish/ Ball material (6)	MSL Peak Temp (3)	Op Temp (°C)	Device Marking (4/5)	Samples
TPS7A5201QRGRRQ1	ACTIVE	VQFN	RGR	20	3000	RoHS & Green	NIPDAU	Level-2-260C-1 YEAR	-40 to 150	A5201	Samples
TPS7A5201WQRTRKQ1	ACTIVE	VQFN	RTK	20	3000	RoHS & Green	NIPDAUAG	Level-2-260C-1 YEAR	-40 to 150	5201WQ	Samples

(1) The marketing status values are defined as follows:

ACTIVE: Product device recommended for new designs.

LIFEBUY: TI has announced that the device will be discontinued, and a lifetime-buy period is in effect.

NRND: Not recommended for new designs. Device is in production to support existing customers, but TI does not recommend using this part in a new design.

PREVIEW: Device has been announced but is not in production. Samples may or may not be available.

OBSOLETE: TI has discontinued the production of the device.

(2) **RoHS:** TI defines "RoHS" to mean semiconductor products that are compliant with the current EU RoHS requirements for all 10 RoHS substances, including the requirement that RoHS substance do not exceed 0.1% by weight in homogeneous materials. Where designed to be soldered at high temperatures, "RoHS" products are suitable for use in specified lead-free processes. TI may reference these types of products as "Pb-Free".

RoHS Exempt: TI defines "RoHS Exempt" to mean products that contain lead but are compliant with EU RoHS pursuant to a specific EU RoHS exemption.

Green: TI defines "Green" to mean the content of Chlorine (Cl) and Bromine (Br) based flame retardants meet JS709B low halogen requirements of <=1000ppm threshold. Antimony trioxide based flame retardants must also meet the <=1000ppm threshold requirement.

(3) MSL, Peak Temp. - The Moisture Sensitivity Level rating according to the JEDEC industry standard classifications, and peak solder temperature.

(4) There may be additional marking, which relates to the logo, the lot trace code information, or the environmental category on the device.

(5) Multiple Device Markings will be inside parentheses. Only one Device Marking contained in parentheses and separated by a "~" will appear on a device. If a line is indented then it is a continuation of the previous line and the two combined represent the entire Device Marking for that device.

(6) Lead finish/Ball material - Orderable Devices may have multiple material finish options. Finish options are separated by a vertical ruled line. Lead finish/Ball material values may wrap to two lines if the finish value exceeds the maximum column width.

Important Information and Disclaimer:The information provided on this page represents TI's knowledge and belief as of the date that it is provided. TI bases its knowledge and belief on information provided by third parties, and makes no representation or warranty as to the accuracy of such information. Efforts are underway to better integrate information from third parties. TI has taken and continues to take reasonable steps to provide representative and accurate information but may not have conducted destructive testing or chemical analysis on incoming materials and chemicals. TI and TI suppliers consider certain information to be proprietary, and thus CAS numbers and other limited information may not be available for release.

In no event shall TI's liability arising out of such information exceed the total purchase price of the TI part(s) at issue in this document sold by TI to Customer on an annual basis.

OTHER QUALIFIED VERSIONS OF TPS7A52-Q1 :

- Catalog: [TPS7A52](#)

NOTE: Qualified Version Definitions:

- Catalog - TI's standard catalog product

TAPE AND REEL INFORMATION

QUADRANT ASSIGNMENTS FOR PIN 1 ORIENTATION IN TAPE

*All dimensions are nominal

Device	Package Type	Package Drawing	Pins	SPQ	Reel Diameter (mm)	Reel Width W1 (mm)	A0 (mm)	B0 (mm)	K0 (mm)	P1 (mm)	W (mm)	Pin1 Quadrant
TPS7A5201QRGRRQ1	VQFN	RGR	20	3000	330.0	12.4	3.75	3.75	1.15	8.0	12.0	Q2
TPS7A5201WQRTKRQ1	VQFN	RTK	20	3000	330.0	15.4	4.3	4.3	1.1	8.0	12.0	Q1

TAPE AND REEL BOX DIMENSIONS



*All dimensions are nominal

Device	Package Type	Package Drawing	Pins	SPQ	Length (mm)	Width (mm)	Height (mm)
TPS7A5201QRGRRQ1	VQFN	RGR	20	3000	367.0	367.0	35.0
TPS7A5201WQRTRQ1	VQFN	RTK	20	3000	336.6	336.6	41.3

RGR (S-PVQFN-N20)

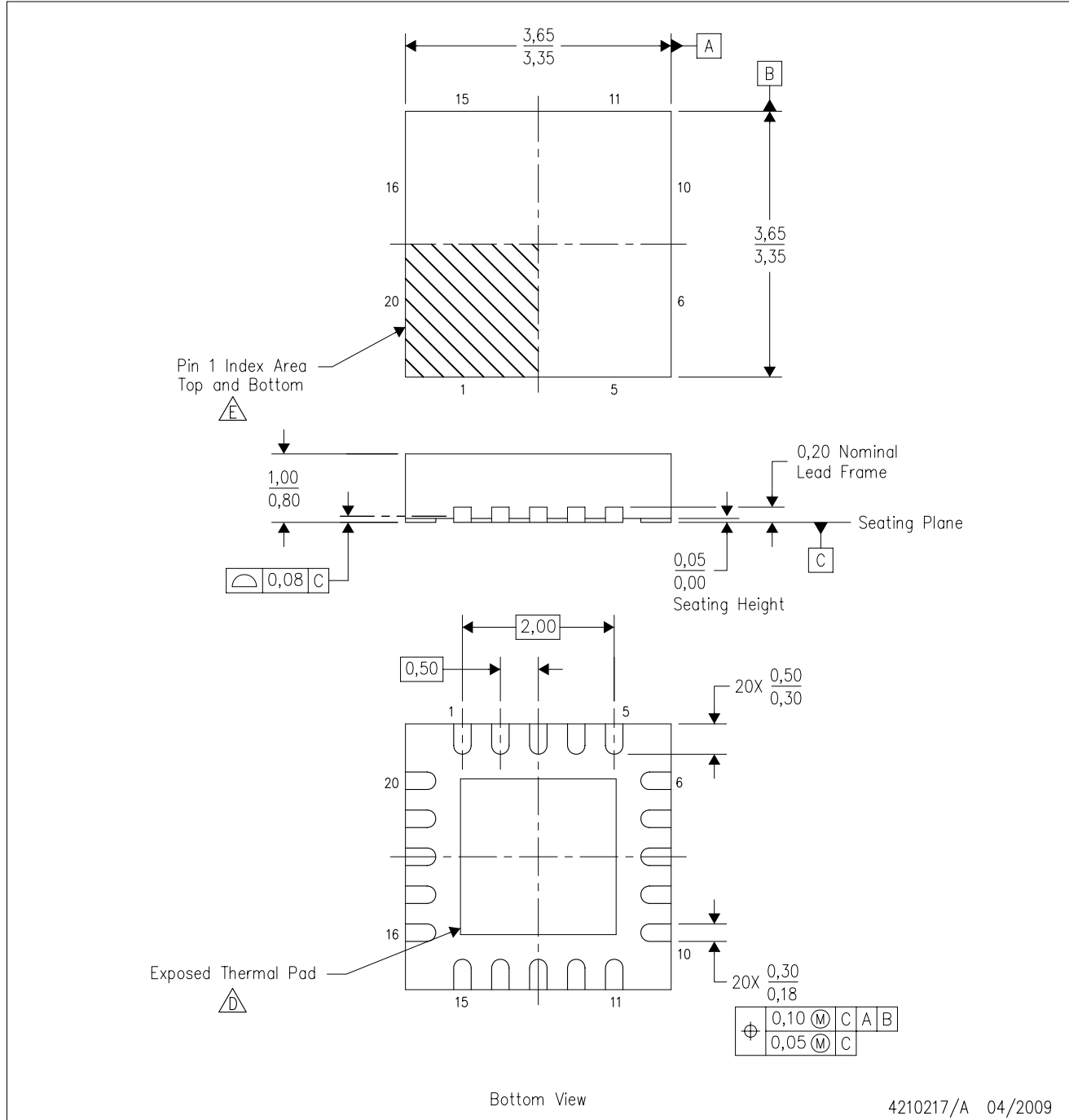
PLASTIC QUAD FLATPACK NO-LEAD



- NOTES:
- A. All linear dimensions are in millimeters. Dimensioning and tolerancing per ASME Y14.5M-1994.
 - B. This drawing is subject to change without notice.
 - C. QFN (Quad Flatpack No-Lead) package configuration.
 -  The package thermal pad must be soldered to the board for thermal and mechanical performance. See the Product Data Sheet for details regarding the exposed thermal pad dimensions.
 -  Pin 1 identifiers are located on both top and bottom of the package and within the zone indicated. The Pin 1 identifiers are either a molded, marked, or metal feature.

THERMAL PAD MECHANICAL DATA

RGR (S-PVQFN-N20)

PLASTIC QUAD FLATPACK NO-LEAD

THERMAL INFORMATION

This package incorporates an exposed thermal pad that is designed to be attached directly to an external heatsink. The thermal pad must be soldered directly to the printed circuit board (PCB). After soldering, the PCB can be used as a heatsink. In addition, through the use of thermal vias, the thermal pad can be attached directly to the appropriate copper plane shown in the electrical schematic for the device, or alternatively, can be attached to a special heatsink structure designed into the PCB. This design optimizes the heat transfer from the integrated circuit (IC).

For information on the Quad Flatpack No-Lead (QFN) package and its advantages, refer to Application Report, QFN/SON PCB Attachment, Texas Instruments Literature No. SLUA271. This document is available at www.ti.com.

The exposed thermal pad dimensions for this package are shown in the following illustration.

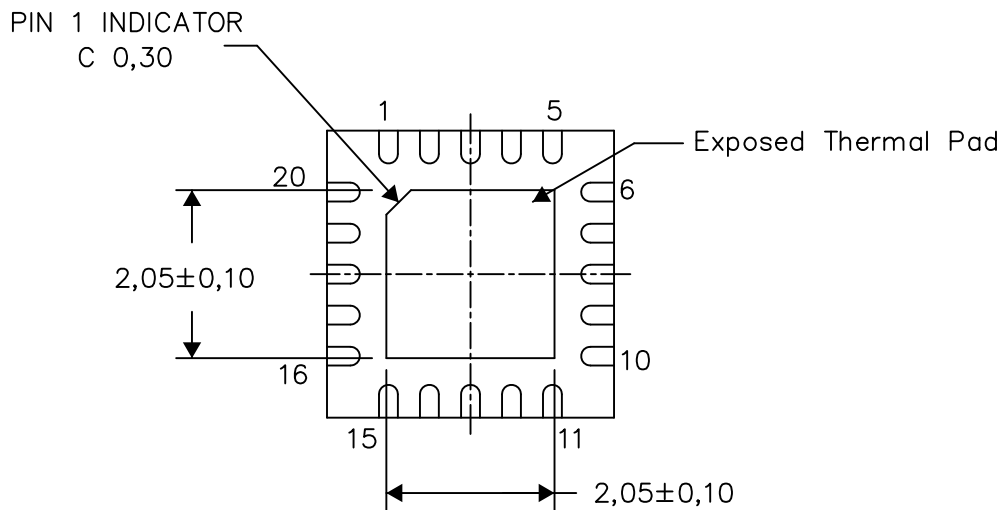

Bottom View

Exposed Thermal Pad Dimensions

4210218/E 04/14

NOTE: All linear dimensions are in millimeters

RGR (S-PVQFN-N20)

PLASTIC QUAD FLATPACK NO-LEAD

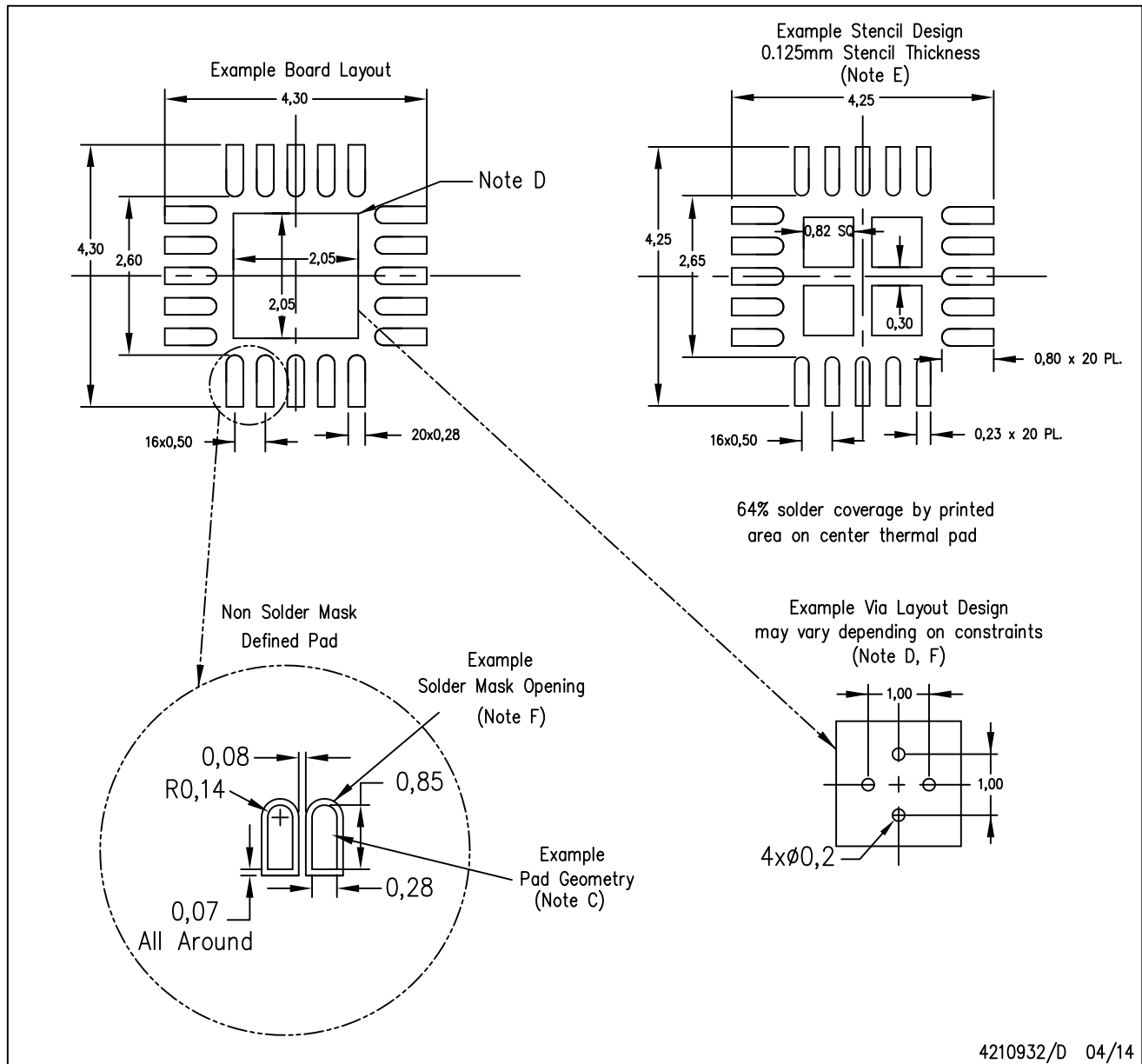

4210932/D 04/14

- NOTES:
- All linear dimensions are in millimeters.
 - This drawing is subject to change without notice.
 - Publication IPC-7351 is recommended for alternate designs.
 - This package is designed to be soldered to a thermal pad on the board. Refer to Application Note, Quad Flat-Pack QFN/SON PCB Attachment, Texas Instruments Literature No. SLUA271, and also the Product Data Sheets for specific thermal information, via requirements, and recommended board layout. These documents are available at www.ti.com <<http://www.ti.com>>.
 - Laser cutting apertures with trapezoidal walls and also rounding corners will offer better paste release. Customers should contact their board assembly site for stencil design recommendations. Refer to IPC 7525 for stencil design considerations.
 - Customers should contact their board fabrication site for minimum solder mask web tolerances between signal pads.

IMPORTANT NOTICE AND DISCLAIMER

TI PROVIDES TECHNICAL AND RELIABILITY DATA (INCLUDING DATASHEETS), DESIGN RESOURCES (INCLUDING REFERENCE DESIGNS), APPLICATION OR OTHER DESIGN ADVICE, WEB TOOLS, SAFETY INFORMATION, AND OTHER RESOURCES "AS IS" AND WITH ALL FAULTS, AND DISCLAIMS ALL WARRANTIES, EXPRESS AND IMPLIED, INCLUDING WITHOUT LIMITATION ANY IMPLIED WARRANTIES OF MERCHANTABILITY, FITNESS FOR A PARTICULAR PURPOSE OR NON-INFRINGEMENT OF THIRD PARTY INTELLECTUAL PROPERTY RIGHTS.

These resources are intended for skilled developers designing with TI products. You are solely responsible for (1) selecting the appropriate TI products for your application, (2) designing, validating and testing your application, and (3) ensuring your application meets applicable standards, and any other safety, security, or other requirements. These resources are subject to change without notice. TI grants you permission to use these resources only for development of an application that uses the TI products described in the resource. Other reproduction and display of these resources is prohibited. No license is granted to any other TI intellectual property right or to any third party intellectual property right. TI disclaims responsibility for, and you will fully indemnify TI and its representatives against, any claims, damages, costs, losses, and liabilities arising out of your use of these resources.

TI's products are provided subject to TI's Terms of Sale (www.ti.com/legal/termsofsale.html) or other applicable terms available either on ti.com or provided in conjunction with such TI products. TI's provision of these resources does not expand or otherwise alter TI's applicable warranties or warranty disclaimers for TI products.

Mailing Address: Texas Instruments, Post Office Box 655303, Dallas, Texas 75265
Copyright © 2020, Texas Instruments Incorporated