

## GPS and GLONASS Front-End Module

### GENERAL DESCRIPTION

The NJG1157PCD is a front-end module (FEM) designed for GPS and GLONASS applications. This FEM offers high gain, low noise figure, high linearity and high out-band rejection characteristics brought by included high performance pre-SAW filter, low noise amplifier (LNA) and post-SAW filter. This FEM can operate from 1.5V to 3.3V single voltage in -40 to 105°C. This FEM has stand-by mode to save current consumption.

This FEM offers very small mounting area by included two SAW filters, only two external components and very small HFFP10-CD package that is 2.5x2.5mm.

### PACKAGE OUTLINE

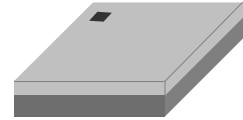

NJG1157PCD

### FEATURES

- Available for GPS and GLONASS
- Low supply voltage
- Low current consumption
- High gain
- Low noise figure
- High out band rejection
- Small package size
- RoHS compliant and Halogen Free, MSL1

- 1.8/ 2.8V typ.
- 2.6/3.3mA typ. @ $V_{DD}=1.8/ 2.8V$ ,  $V_{CTL}=1.8V$
- 0.1 $\mu$ A typ. @ $V_{DD}=1.8/ 2.8V$ ,  $V_{CTL}=0V$  (Stand-by mode)
- 17.5/18.5dB typ. @ $V_{DD}=1.8/ 2.8V$ ,  $V_{CTL}=1.8V$ ,  
f=1575MHz, 1597 to 1606MHz
- 1.65/1.60dB typ. @ $V_{DD}=1.8/ 2.8V$ ,  $V_{CTL}=1.8V$ , f=1575MHz
- 1.75/1.70dB typ. @ $V_{DD}=1.8/ 2.8V$ ,  $V_{CTL}=1.8V$ , f=1597 to 1606MHz
- 85dBc typ. @f=704 to 915MHz, relative to 1575MHz
- 75dBc typ. @f=1710 to 1980MHz, relative to 1575MHz
- HFFP10-CD: 2.5mmx2.5mmx0.63mm max.

### PIN CONFIGURATION

(Top View)

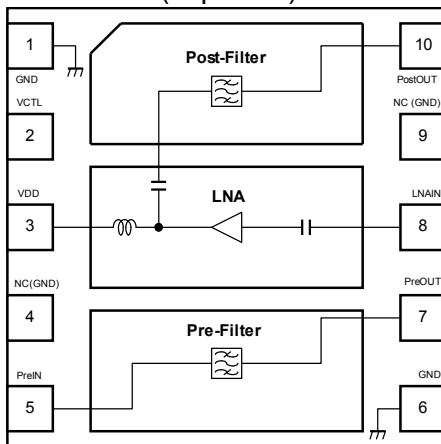

Pin connection

1. GND
2. VCTL
3. VDD
4. NC(GND)
5. PreIN
6. GND
7. PreOUT
8. LNAIN
9. NC(GND)
10. PostOUT

Exposed pad: GND

### BLOCK DIAGRAM

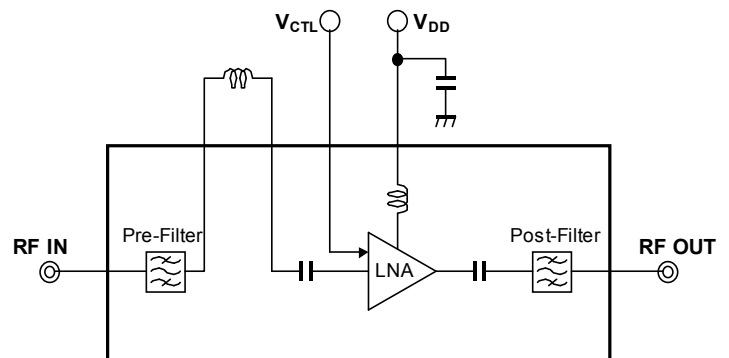

### TRUTH TABLE

"H"= $V_{CTL}(H)$ , "L"= $V_{CTL}(L)$

| VCTL | Mode          |
|------|---------------|
| H    | Active mode   |
| L    | Stand-by mode |

Note: Specifications and description listed in this datasheet are subject to change without notice.

# NJG1157PCD

## ■ ABSOLUTE MAXIMUM RATINGS

$T_a=+25^{\circ}\text{C}$ ,  $Z_s=Z_l=50\Omega$

| PARAMETERS            | SYMBOL             | CONDITIONS  | RATINGS     | UNITS              |
|-----------------------|--------------------|---|-------------|--------------------|
| Supply voltage        | $V_{DD}$           |   | 5.0         | V                  |
| Control voltage       | $V_{CTL}$          |   | 5.0         | V                  |
| Input power           | $P_{IN}$ (inband)  | $V_{DD}=2.8\text{V}$ ,<br>$f=1575, 1597$ to $1606\text{MHz}$                                      | +15         | dBm                |
|                       | $P_{IN}$ (outband) | $V_{DD}=2.8\text{V}$ ,<br>$f=50$ to $1460, 1710$ to $4000\text{MHz}$                              | +27         | dBm                |
| Power dissipation     | $P_D$              | 4-layer FR4 PCB with through-hole<br>( $101.5 \times 114.5\text{mm}$ ), $T_i=110^{\circ}\text{C}$ | 580         | mW                 |
| Operating temperature | $T_{opr}$          |   | -40 to +105 | $^{\circ}\text{C}$ |
| Storage temperature   | $T_{stg}$          |   | -40 to +110 | $^{\circ}\text{C}$ |

## ■ ELECTRICAL CHARACTERISTICS 1 (DC)

(General conditions:  $T_a=+25^{\circ}\text{C}$ )

| PARAMETER              | SYMBOL       | CONDITIONS  | MIN | TYP | MAX  | UNITS         |
|------------------------|--------------|---|-----|-----|------|---------------|
| Supply Voltage         | $V_{DD}$     |   | 1.5 | -   | 3.3  | V             |
| Control Voltage (High) | $V_{CTL(H)}$ |   | 1.5 | 1.8 | 3.3  | V             |
| Control Voltage (Low)  | $V_{CTL(L)}$ |   | 0   | 0   | 0.3  | V             |
| Supply Current 1       | $I_{DD1}$    | RF OFF,<br>$V_{DD}=2.8\text{V}$ , $V_{CTL}=1.8\text{V}$ | -   | 3.3 | 6.4  | mA            |
| Supply Current 2       | $I_{DD2}$    | RF OFF,<br>$V_{DD}=1.8\text{V}$ , $V_{CTL}=1.8\text{V}$ | -   | 2.6 | 5.9  | mA            |
| Supply Current 3       | $I_{DD3}$    | RF OFF,<br>$V_{DD}=2.8\text{V}$ , $V_{CTL}=0\text{V}$   | -   | 0.1 | 5.0  | $\mu\text{A}$ |
| Supply Current 4       | $I_{DD4}$    | RF OFF,<br>$V_{DD}=1.8\text{V}$ , $V_{CTL}=0\text{V}$   | -   | 0.1 | 5.0  | $\mu\text{A}$ |
| Control Current        | $I_{CTL}$    | $V_{CTL}=1.8\text{V}$                                   | -   | 5.0 | 15.0 | $\mu\text{A}$ |

## ■ ELECTRICAL CHARACTERISTICS 2 (RF)

General conditions:  $V_{DD}=2.8V$ ,  $V_{CTL}=1.8V$ ,  $f_{RF}=1575MHz$ , 1597 to 1606MHz,  $T_a=+25^{\circ}C$ ,  $Z_s=Z_L=50\Omega$ , with application circuit

| PARAMETER                                     | SYMBOL          | CONDITIONS   | MIN  | TYP   | MAX | UNITS |
|---|-----------------|--|------|-------|-----|-------|
| Small Signal Gain (GPS)1                      | GainGPS1        | f=1575MHz (GPS), Exclude PCB, Connector Losses (0.19dB)                        | 17.0 | 18.5  | -   | dB    |
| Small Signal Gain (GLONASS)1                  | GainGLN1        | f=1597 to 1606MHz (GLONASS) Exclude PCB, Connector Losses (0.19dB)             | 17.0 | 18.5  | -   | dB    |
| Noise Figure (GPS)1                           | NFGPS1          | f=1575MHz (GPS) Exclude PCB, Connector Losses (0.09dB)                         | -    | 1.6   | 2.1 | dB    |
| Noise Figure (GLONASS)1                       | NFGLN1          | f=1597 to 1606MHz (GLONASS) Exclude PCB, Connector Losses (0.09dB)             | -    | 1.7   | 2.2 | dB    |
| Input Power at 1dB Gain Compression Point 1   | P-1dB(IN)1      | f=1575, 1597 to 1606MHz  | -    | -15.0 | -   | dBm   |
| Input 3rd Order Intercept Point 1             | IIP3_1          | f1=1575MHz, f2=f1+/- 1MHz, Pin=-30dBm  | -    | -3.0  | -   | dBm   |
| Out of Band Input 2nd Order Intercept Point 1 | IIP2_OB1        | f1=824.6MHz at +15dBm, f2=2400MHz at +15dBm, fmeas=1575.4MHz                   | -    | +72   | -   | dBm   |
| Out of Band Input 3rd Order Intercept Point 1 | IIP3_OB1        | f1=1712.7MHz at +15dBm, f2=1850MHz at +15dBm, fmeas=1575.4MHz                  | -    | +50   | -   | dBm   |
| 700MHz Harmonic1                              | 2fo1            | Input jammer tone: 787.76MHz at +15dBm Measure the harmonic tone at 1575.52MHz | -    | -30   | -   | dBm   |
| Out-of-Band Input Power 1dB Compression 1     | P-1dB(IN)_OB1-1 | fjam=900MHz, fmeas=1575MHz at Pin=-40dBm                                       | -    | +24   | -   | dBm   |
|   | P-1dB(IN)_OB1-2 | fjam=1710MHz, fmeas=1575MHz at Pin=-40dBm                                      | -    | +24   | -   | dBm   |
| Low Band Rejection 1                          | BR_L1           | f=704 to 915MHz, relative to 1575MHz   | -    | 85    | -   | dBc   |
| High Band Rejection 1                         | BR_H1           | f=1710 to 1980MHz, relative to 1575MHz   | -    | 75    | -   | dBc   |
| WLAN Band Rejection 1                         | BR_W1           | f=2400 to 2500MHz, relative to 1575MHz   | -    | 72    | -   | dBc   |
| RF IN Return Loss (GPS)1                      | RLiGPS1         | f=1575MHz (GPS)  | -    | 7.5   | -   | dB    |
| RF IN Return Loss (GLONASS)1                  | RLiGLN1         | f=1597 to 1606MHz (GLONASS)  | -    | 7.5   | -   | dB    |
| RF OUT Return Loss (GPS)1                     | RLoGPS1         | f=1575MHz (GPS)  | -    | 11    | -   | dB    |
| RF OUT Return Loss (GLONASS)1                 | RLoGLN1         | f=1597 to 1606MHz (GLONASS)  | -    | 15    | -   | dB    |
| Group Delay Time Deviation 1                  | GDTD1           | f=1597 to 1606MHz (GLONASS)  | -    | 8.0   | -   | ns    |

# NJG1157PCD

## ■ ELECTRICAL CHARACTERISTICS 3 (RF)

General conditions:  $V_{DD}=1.8V$ ,  $V_{CTL}=1.8V$ ,  $f_{RF}=1575MHz$ , 1597 to 1606MHz,  $T_a=+25^{\circ}C$ ,  $Z_s=Z_l=50\Omega$ , with application circuit

| PARAMETER                                     | SYMBOL                 | CONDITIONS  | MIN  | TYP   | MAX  | UNITS |
|---|------------------------|---|------|-------|------|-------|
| Small Signal Gain (GPS) <sup>2</sup>          | GainGPS2               | f=1575MHz (GPS) Exclude PCB, Connector Losses (0.19dB)                            | 15.5 | 17.5  | -    | dB    |
| Small Signal Gain (GLONASS) <sup>2</sup>      | GainGLN2               | f=1597 to 1606MHz (GLONASS) Exclude PCB, Connector Losses (0.19dB)                | 15.5 | 17.5  | -    | dB    |
| Noise Figure (GPS) <sup>2</sup>               | NFGPS2                 | f=1575MHz (GPS) Exclude PCB, Connector Losses (0.09dB)                            | -    | 1.65  | 2.20 | dB    |
| Noise Figure (GLONASS) <sup>2</sup>           | NFGLN2                 | f=1597 to 1606MHz (GLONASS) Exclude PCB, Connector Losses (0.09dB)                | -    | 1.75  | 2.35 | dB    |
| Input Power at 1dB Gain Compression Point 2   | P-1dB(IN) <sup>2</sup> | f=1575, 1597 to 1606MHz   | -    | -17.0 | -    | dBm   |
| Input 3rd Order Intercept Point 2             | IIP3_2                 | f1=1575MHz, f2=f1+/- 1MHz, Pin=-30dBm   | -    | -6.0  | -    | dBm   |
| Out of Band Input 2nd Order Intercept Point 2 | IIP2_OB2               | f1=824.6MHz at +15dBm, f2=2400MHz at +15dBm, fmeas=1575.4MHz                      | -    | +72   | -    | dBm   |
| Out of Band Input 3rd Order Intercept Point 2 | IIP3_OB2               | f1=1712.7MHz at +15dBm, f2=1850MHz at +15dBm, fmeas=1575.4MHz                     | -    | +50   | -    | dBm   |
| 700MHz Harmonic <sup>2</sup>                  | 2fo2                   | Input jammer tone: 787.76MHz at +15dBm<br>Measure the harmonic tone at 1575.52MHz | -    | -30   | -    | dBm   |
| Out-of-Band Input Power 1dB Compression 2     | P-1dB(IN)_OB2-1        | fjam=900MHz, fmeas=1575MHz at Pin=-40dBm  | -    | +24   | -    | dBm   |
|   | P-1dB(IN)_OB2-2        | fjam=1710MHz, fmeas=1575MHz at Pin=-40dBm   | -    | +24   | -    | dBm   |
| Low Band Rejection 2                          | BR_L2                  | f=704 to 915MHz, relative to 1575MHz  | -    | 85    | -    | dBc   |
| High Band Rejection 2                         | BR_H2                  | f=1710 to 1980MHz, relative to 1575MHz  | -    | 75    | -    | dBc   |
| WLAN Band Rejection 2                         | BR_W2                  | f=2400 to 2500MHz, relative to 1575MHz  | -    | 72    | -    | dBc   |
| RF IN Return Loss (GPS) <sup>2</sup>          | RLiGPS2                | f=1575MHz (GPS)   | -    | 7.5   | -    | dB    |
| RF IN Return Loss (GLONASS) <sup>2</sup>      | RLiGLN2                | f=1597 to 1606MHz (GLONASS)   | -    | 7.5   | -    | dB    |
| RF OUT Return Loss (GPS) <sup>2</sup>         | RLoGPS2                | f=1575MHz (GPS)   | -    | 10    | -    | dB    |
| RF OUT Return Loss (GLONASS) <sup>2</sup>     | RLoGLN2                | f=1597 to 1606MHz (GLONASS)   | -    | 13    | -    | dB    |
| Group Delay Time Deviation 2                  | GDTD2                  | f=1597 to 1606MHz (GLONASS)   | -    | 8.0   | -    | ns    |

## ■ TERMINAL INFORMATION

| No.         | SYMBOL  | DESCRIPTION  |
|-------------|---------|--|
| 1           | GND     | Ground terminal. This terminal should be connected to the ground plane as close as possible for excellent RF performance.                                      |
| 2           | VCTL    | Control voltage terminal.  |
| 3           | VDD     | Supply voltage terminal. Please connect bypass capacitor C1 with ground as close as possible.  |
| 4           | NC(GND) | No connected terminal. This terminal is not connected with internal circuit. Please connect to the PCB ground Plane.   |
| 5           | PreIN   | RF input terminal. This terminal connects to input of pre-SAW filter.  |
| 6           | GND     | Ground terminal. This terminal should be connected to the ground plane as close as possible for excellent RF performance.                                      |
| 7           | PreOUT  | Pre-SAW filter output terminal. This terminal connects to LNAIN with L1.   |
| 8           | LNAIN   | RF input terminal. This terminal requires only a matching inductor L1, and does not require DC blocking capacitor because of integrated capacitor.             |
| 9           | NC(GND) | No connected terminal. This terminal is not connected with internal circuit. Please connect to the PCB ground Plane.   |
| 10          | PostOUT | RF output terminal. This terminal requires no DC blocking capacitor since this terminal has integrated SAW that also works as DC blocking capacitor in nature. |
| Exposed Pad | GND     | Ground terminal.   |

# NJG1157PCD

## ELECTRICAL CHARACTERISTICS

Conditions:  $V_{DD}=2.8V$ ,  $V_{CTL}=1.8V$ ,  $T_a=25^\circ C$ ,  $Z_s=Z_l=50\Omega$ , with application circuit

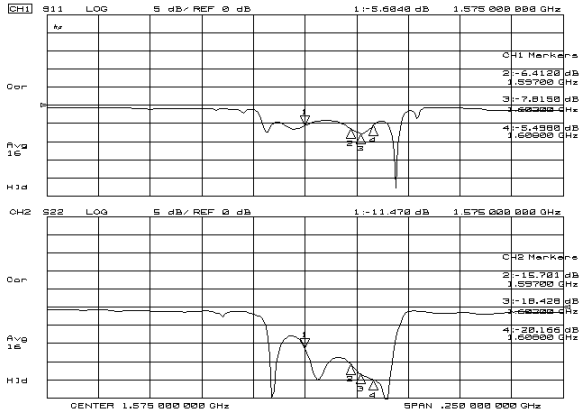

S11, S22

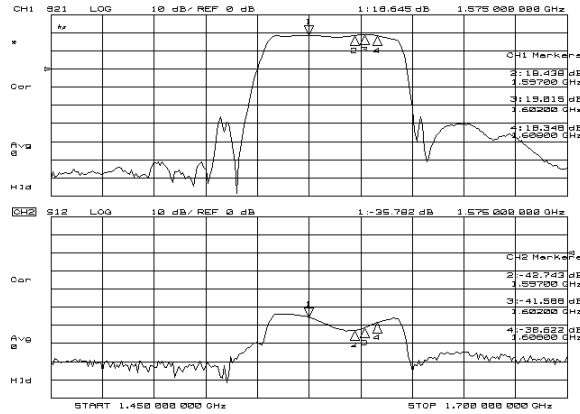

S21, S12

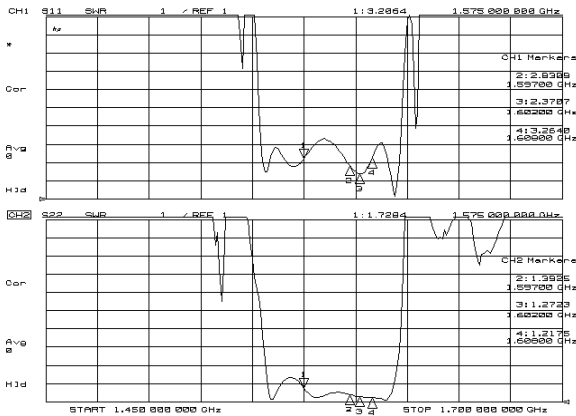

VSWR

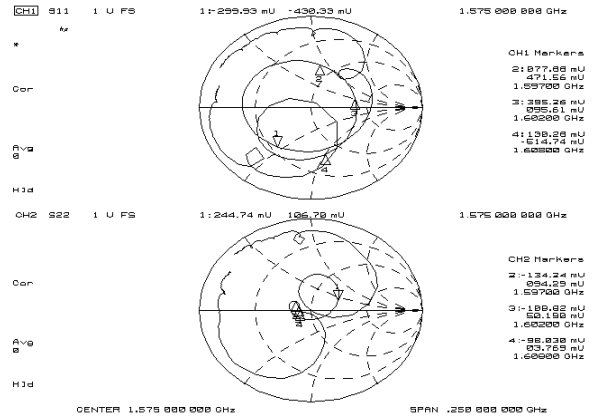

Zin, Zout

## ■ ELECTRICAL CHARACTERISTICS

Conditions:  $V_{DD}=2.8V$ ,  $V_{CTL}=1.8V$ ,  $T_a=25^\circ C$ ,  $Z_s=Z_l=50\Omega$ , with application circuit

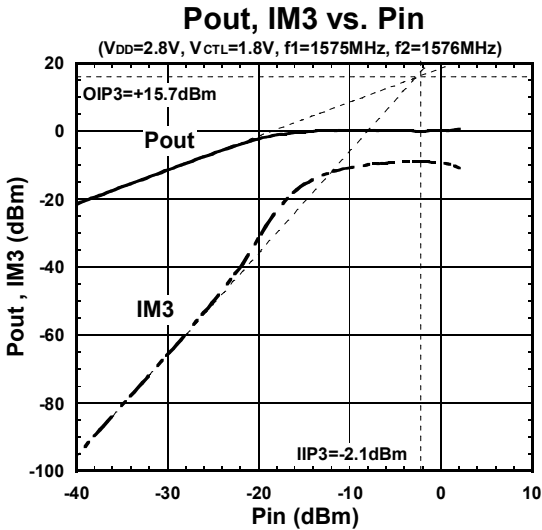
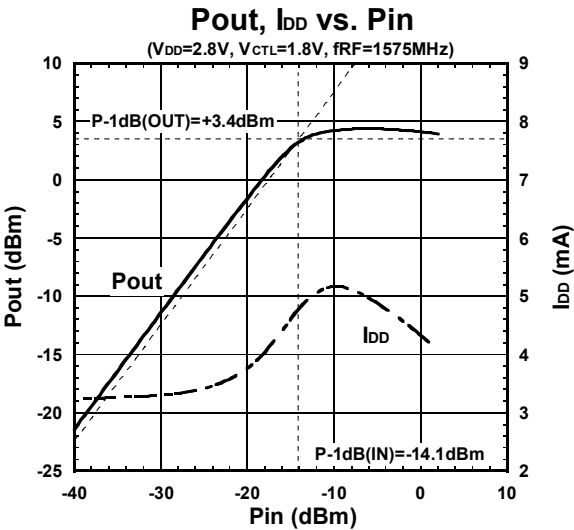
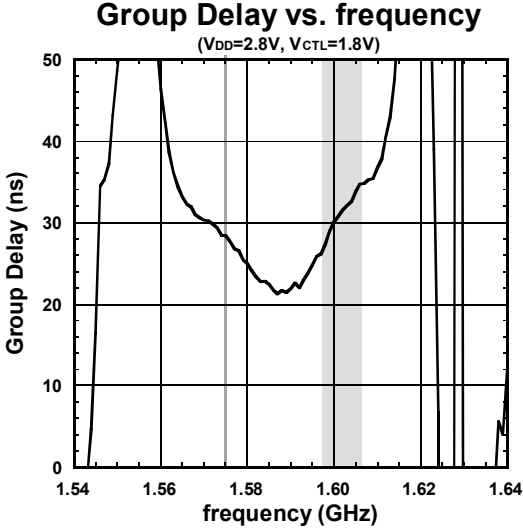
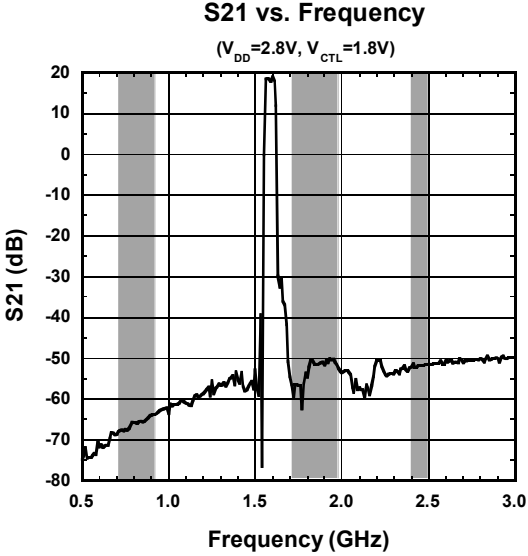
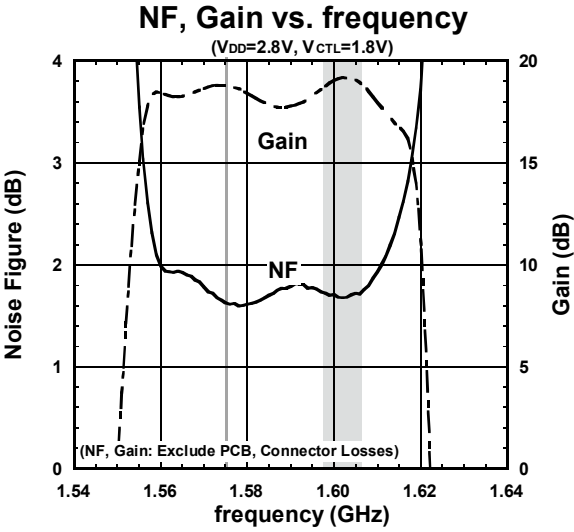

# NJG1157PCD

## ■ ELECTRICAL CHARACTERISTICS

Conditions:  $V_{DD}=2.8V$ ,  $V_{CTL}=1.8V$ ,  $T_a=25^\circ C$ ,  $Z_s=Z_l=50\Omega$ , with application circuit

**Out-of-band P-1dB (fjam=900MHz)**

( $V_{DD}=2.8V$ ,  $V_{CTL}=1.8V$ ,  $f_{meas}=1575MHz$  at  $Pin=-40dBm$ )

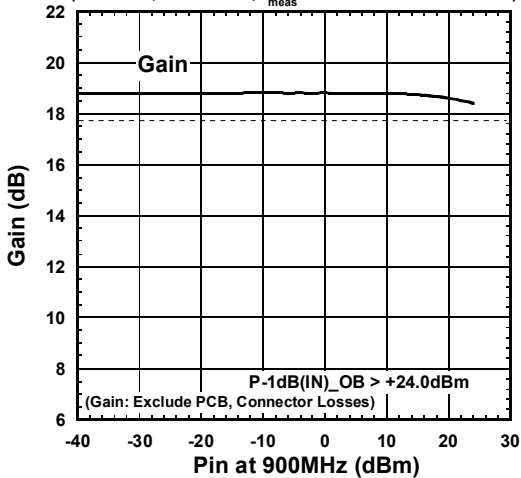

**Out-of-band P-1dB (fjam=1710MHz)**

( $V_{DD}=2.8V$ ,  $V_{CTL}=1.8V$ ,  $f_{meas}=1575MHz$  at  $Pin=-40dBm$ )

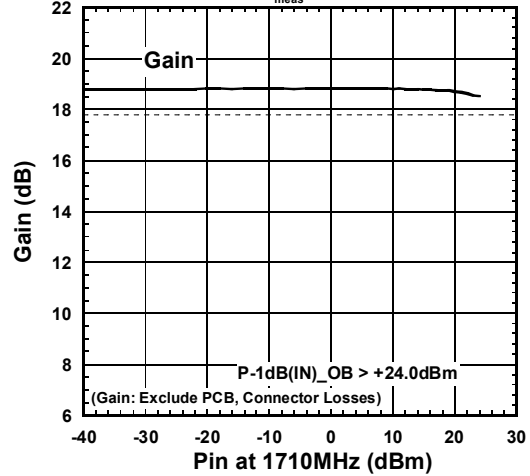

**Out-of-band IIP2**

( $V_{DD}=2.8V$ ,  $V_{CTL}=1.8V$ ,  $f_{meas}=1575.4MHz$ ,  
 $f_1=824.6MHz$ ,  $f_2=2400MHz$ )

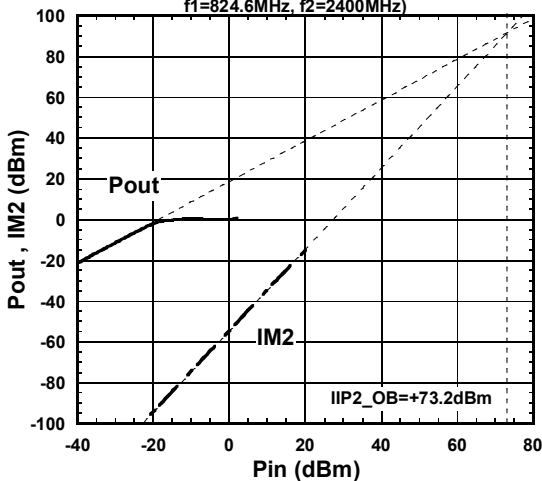

**Out-of-band IIP3**

( $V_{DD}=2.8V$ ,  $V_{CTL}=1.8V$ ,  $f_{meas}=1575.4MHz$ ,  
 $f_1=1712.7MHz$ ,  $f_2=1850MHz$ )

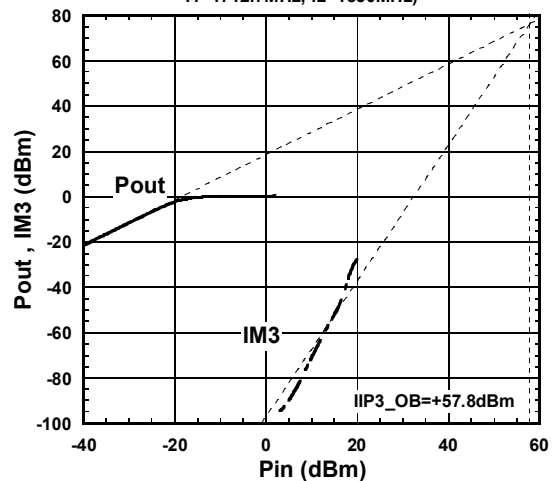

**2nd Harmonics**

( $V_{DD}=2.8V$ ,  $V_{CTL}=1.8V$ ,  
 $f_{in}=787.76MHz$ ,  $f_{meas}=1575.52MHz$ )

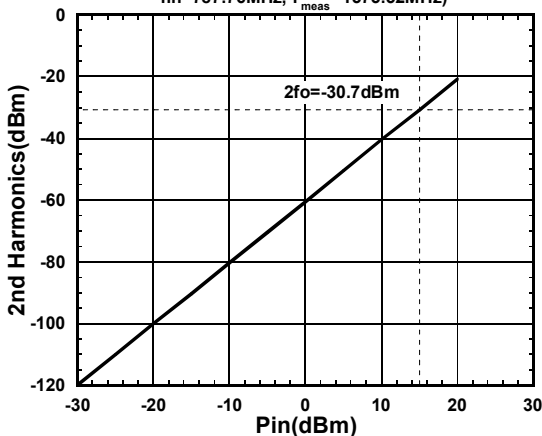



## ELECTRICAL CHARACTERISTICS

Conditions:  $V_{DD}=1.8V$ ,  $V_{CTL}=1.8V$ ,  $T_a=25^{\circ}C$ ,  $Z_S=Z_I=50\Omega$ , with application circuit

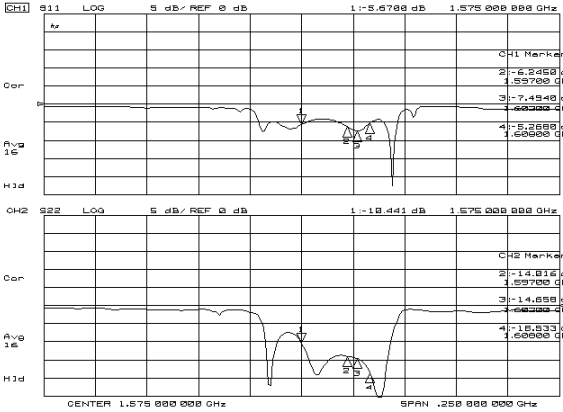

S11, S22

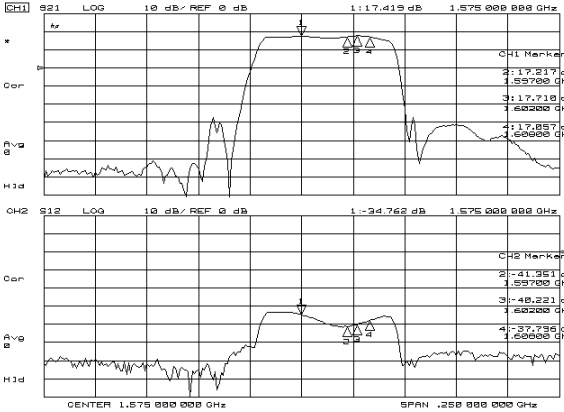

S21, S12

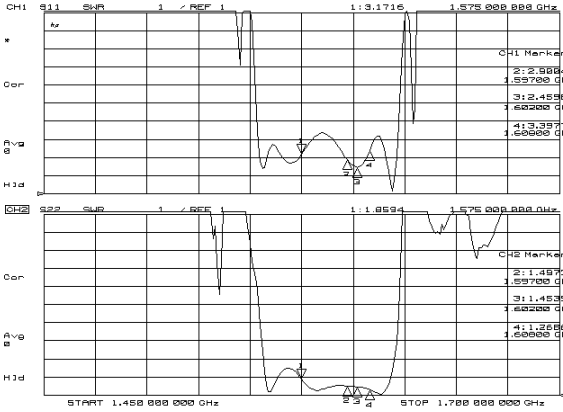

VSWR

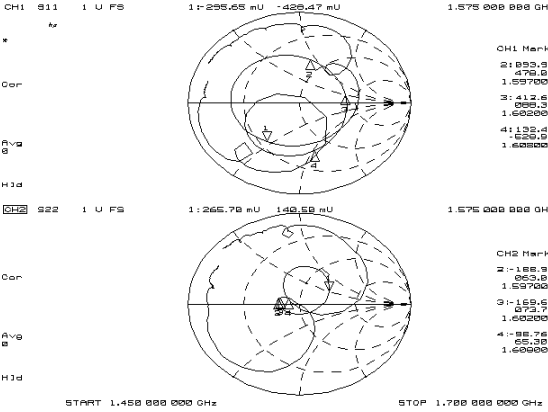

Zin, Zout

# NJG1157PCD

## ■ ELECTRICAL CHARACTERISTICS

Conditions:  $V_{DD}=1.8V$ ,  $V_{CTL}=1.8V$ ,  $T_a=25^\circ C$ ,  $Z_s=Z_l=50\Omega$ , with application circuit

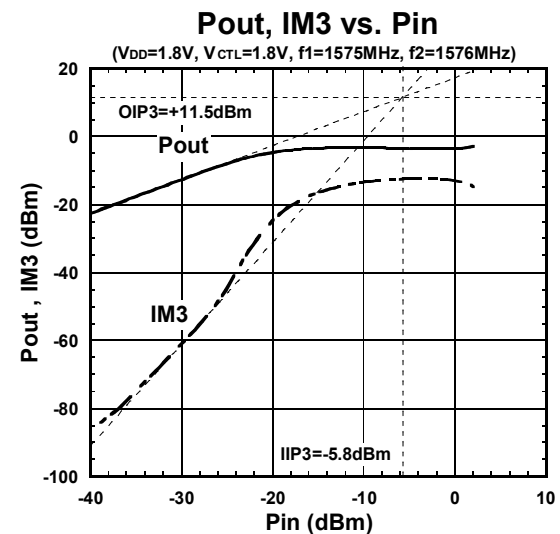
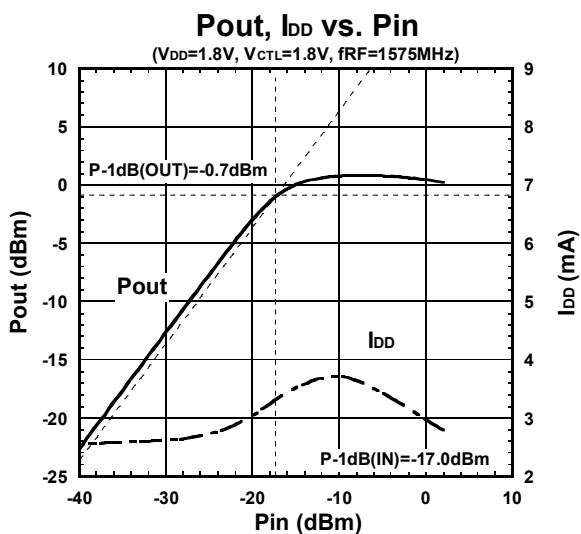
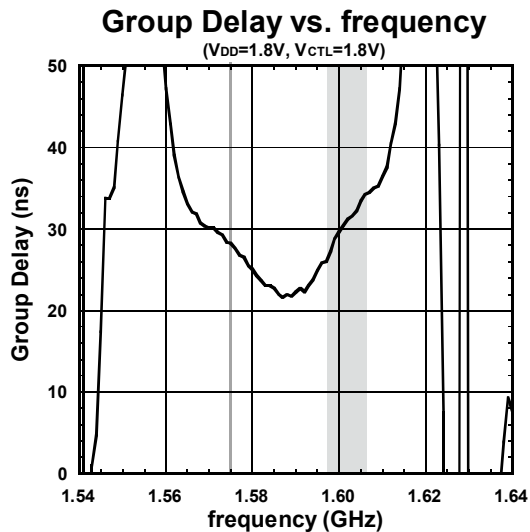
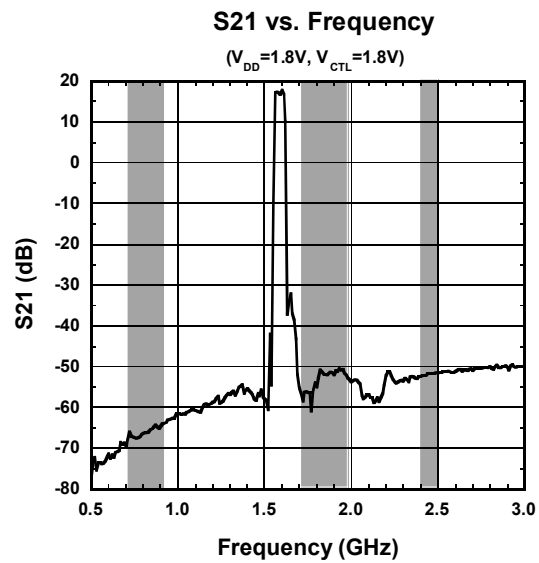
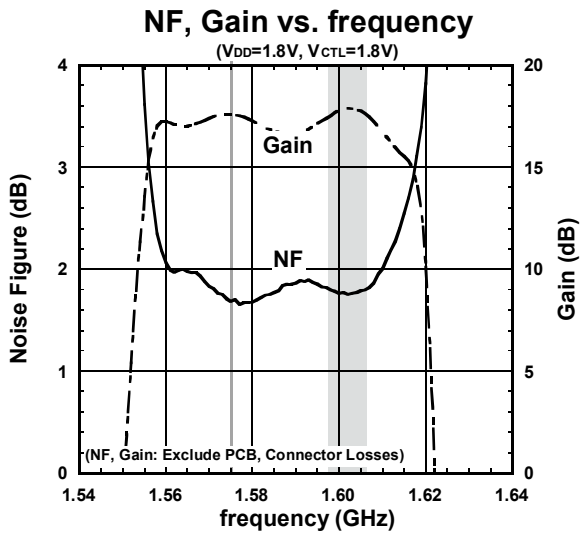

**■ ELECTRICAL CHARACTERISTICS**

Conditions:  $V_{DD}=1.8V$ ,  $V_{CTL}=1.8V$ ,  $T_a=25^\circ C$ ,  $Z_s=Z_l=50\Omega$ , with application circuit

**Out-of-band P-1dB (fjam=900MHz)**

( $V_{DD}=1.8V$ ,  $V_{CTL}=1.8V$ ,  $f_{meas}=1575MHz$  at  $Pin=-40dBm$ )

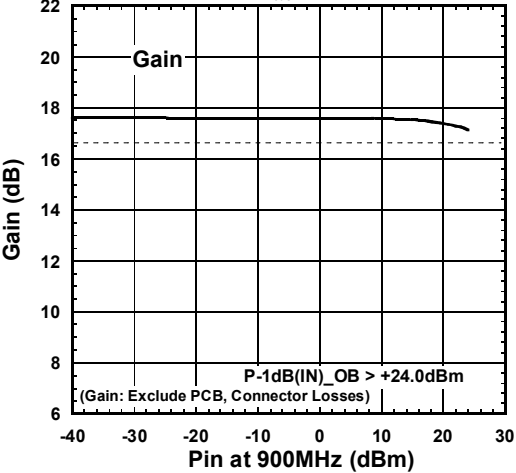

**Out-of-band P-1dB (fjam=1710MHz)**

( $V_{DD}=1.8V$ ,  $V_{CTL}=1.8V$ ,  $f_{meas}=1575MHz$  at  $Pin=-40dBm$ )

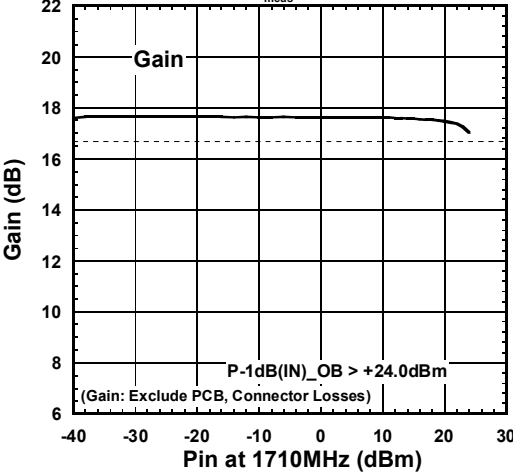

**Out-of-band IIP2**

( $V_{DD}=1.8V$ ,  $V_{CTL}=1.8V$ ,  $f_{meas}=1575.4MHz$ ,  
 $f_1=824.6MHz$ ,  $f_2=2400MHz$ )

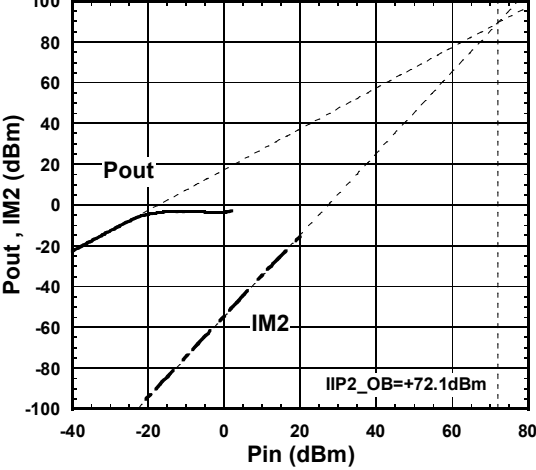

**Out-of-band IIP3**

( $V_{DD}=1.8V$ ,  $V_{CTL}=1.8V$ ,  $f_{meas}=1575.4MHz$ ,  
 $f_1=1712.7MHz$ ,  $f_2=1850MHz$ )

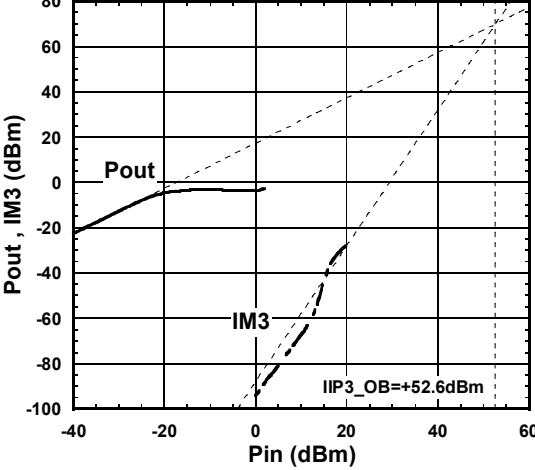

**2nd Harmonics**

( $V_{DD}=1.8V$ ,  $V_{CTL}=1.8V$ ,  
 $f_{in}=787.76MHz$ ,  $f_{meas}=1575.52MHz$ )

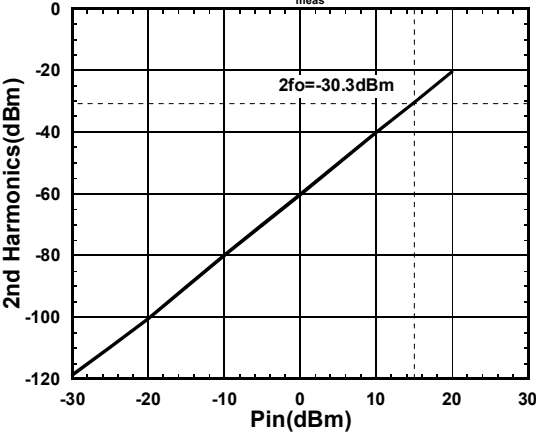

# NJG1157PCD

## ■ ELECTRICAL CHARACTERISTICS

Conditions:  $V_{DD}=2.8V$ ,  $V_{CTL}=1.8V$ ,  $Z_s=Z_l=50\Omega$ , with application circuit

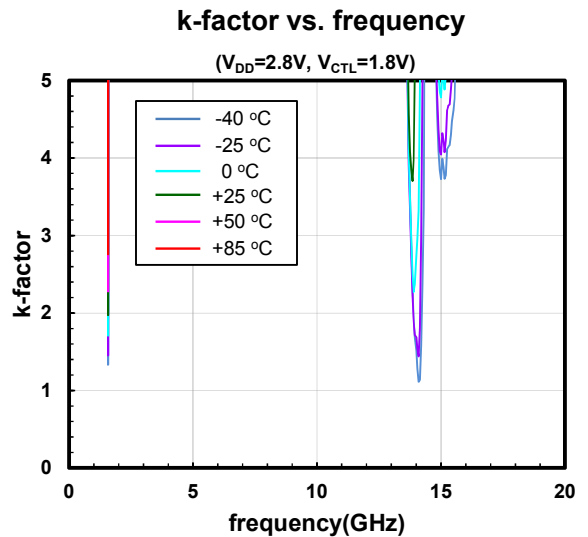
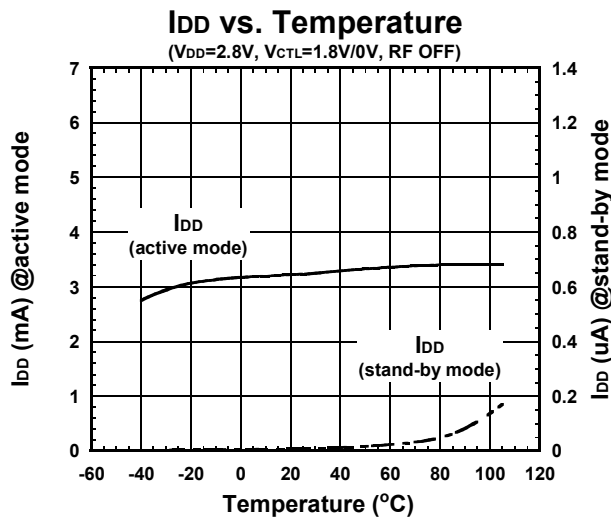
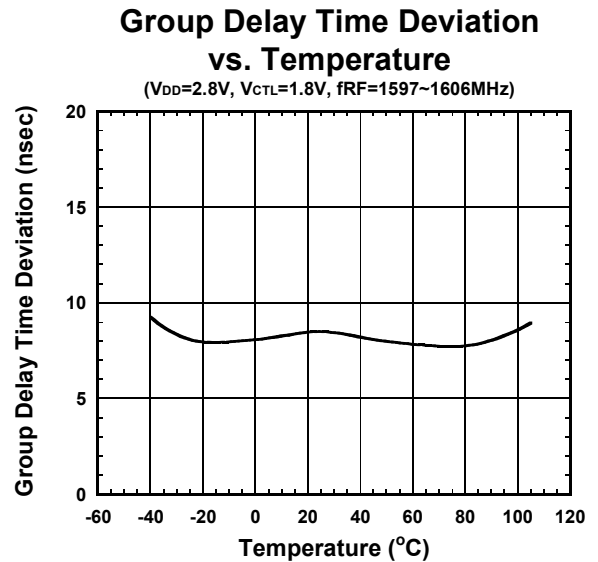
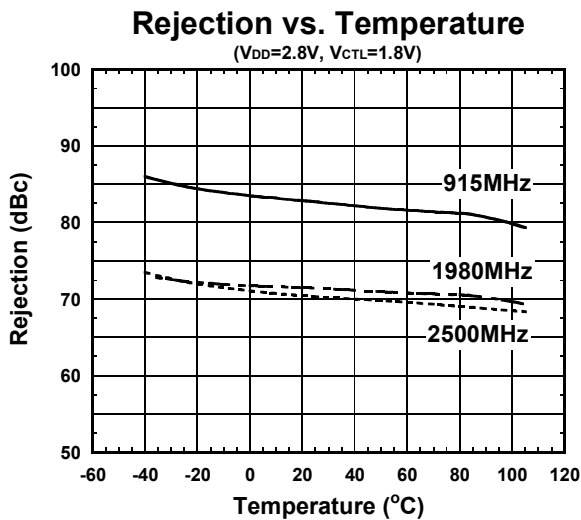
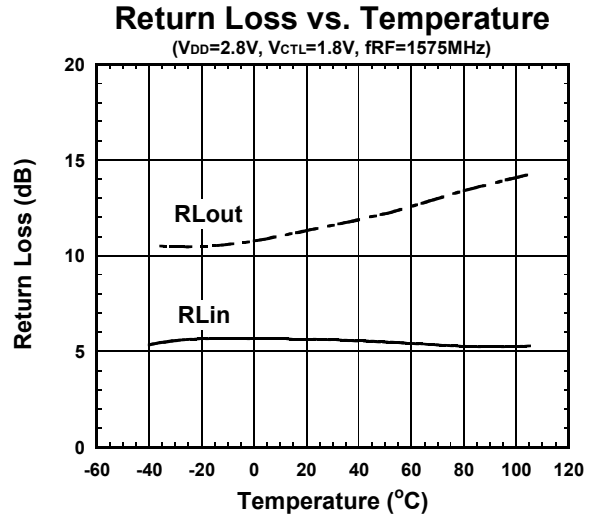
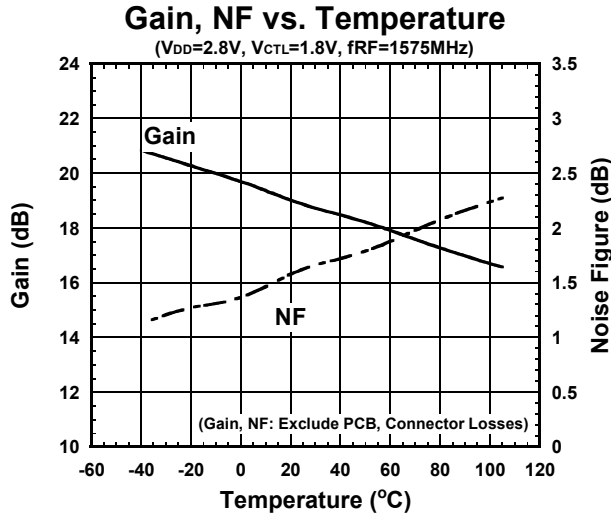

## ELECTRICAL CHARACTERISTICS

Conditions:  $V_{DD}=2.8V$ ,  $V_{CTL}=1.8V$ ,  $Z_s=Z_l=50\Omega$ , with application circuit

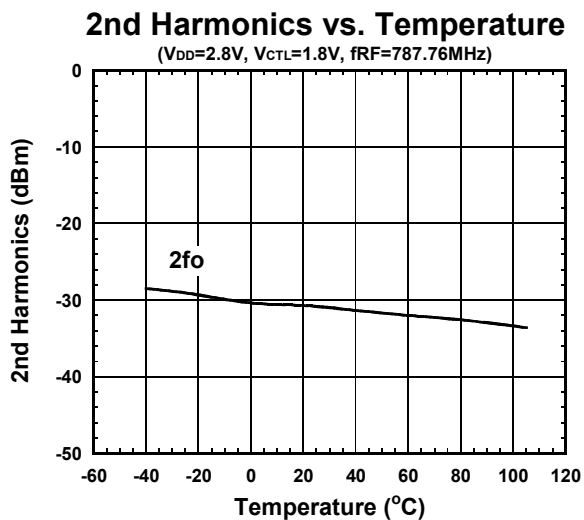
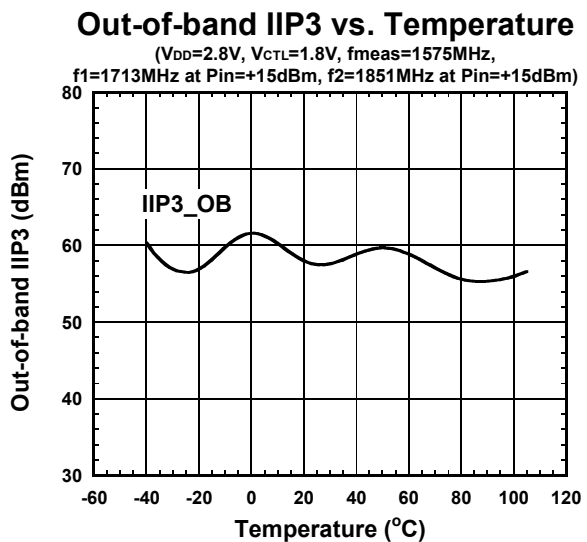
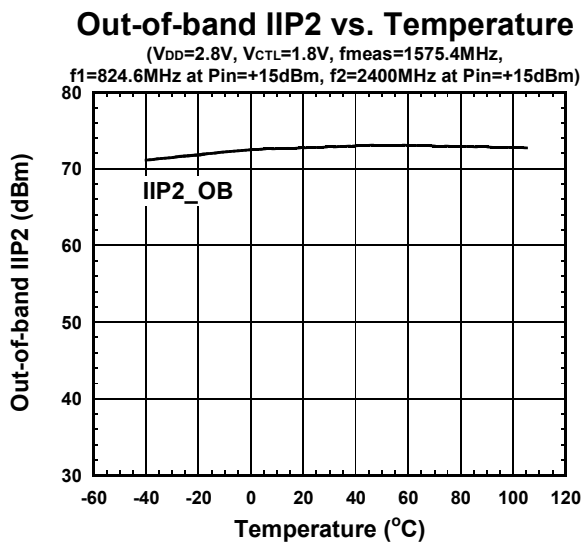
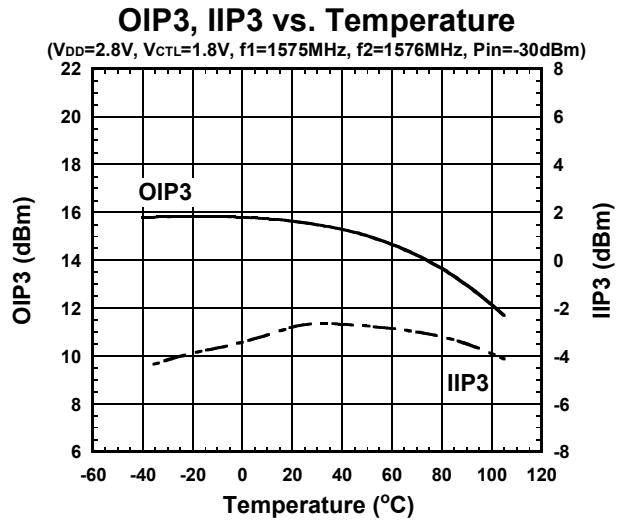
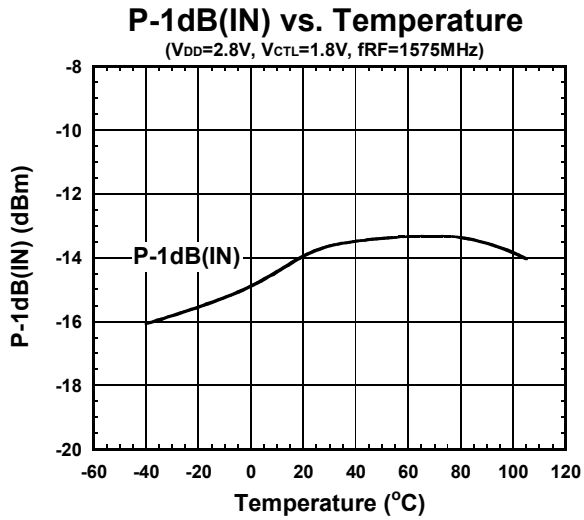

# NJG1157PCD

## ■ ELECTRICAL CHARACTERISTICS

Conditions:  $V_{CTL}=1.8V$ ,  $T_a=25^\circ C$ ,  $Z_s=Z_l=50\Omega$ , with application circuit

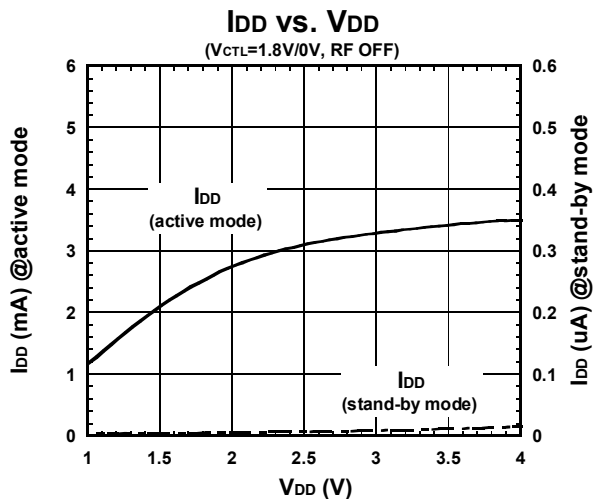
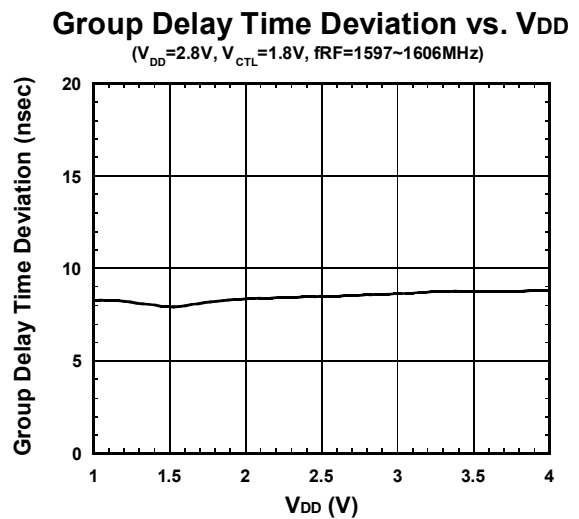
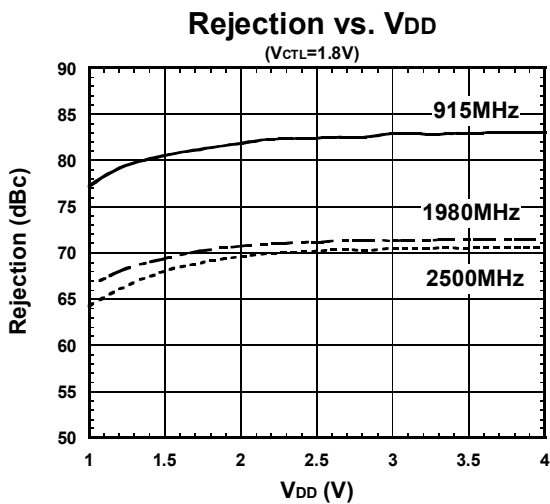
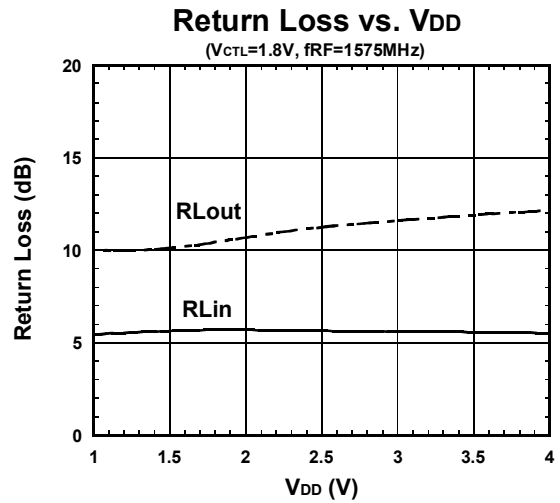
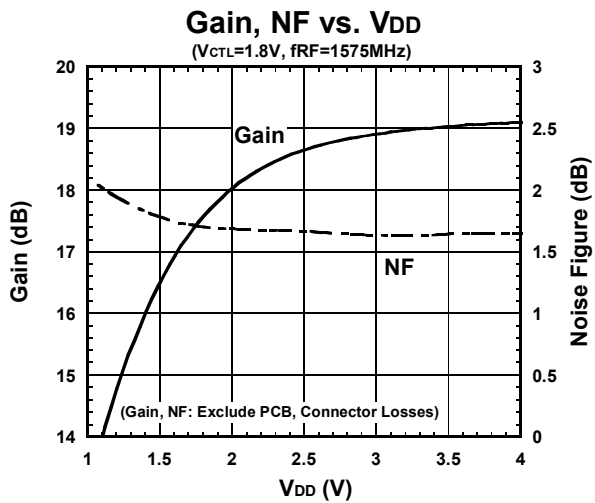

## ■ ELECTRICAL CHARACTERISTICS

Conditions:  $V_{CTL}=1.8V$ ,  $T_a=25^{\circ}C$ ,  $Z_s=Z_l=50\Omega$ , with application circuit

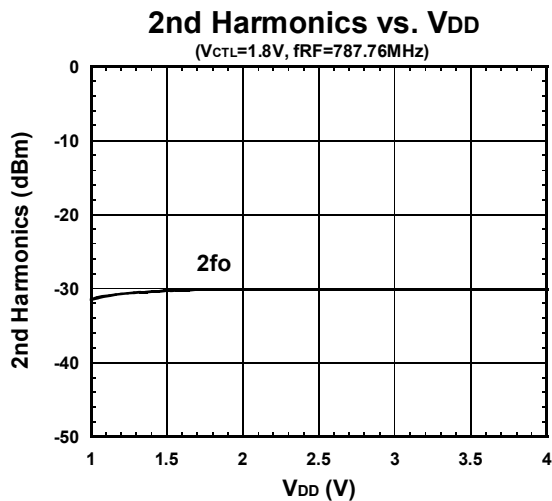
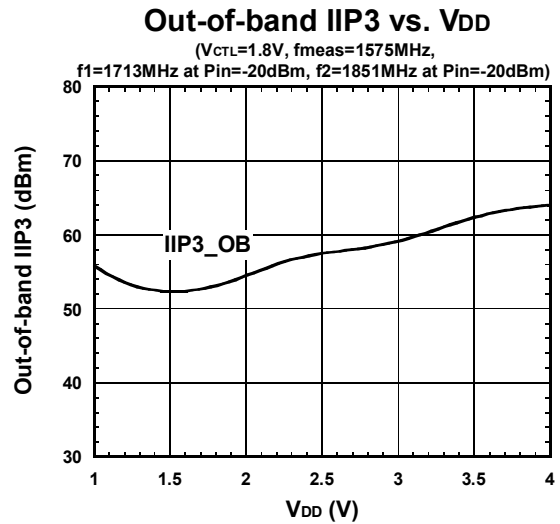
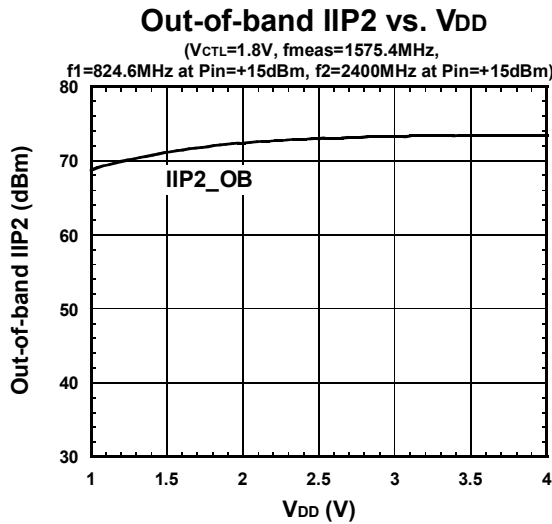
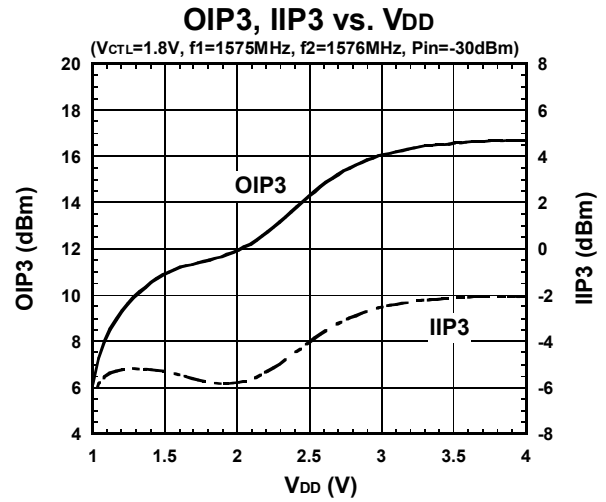
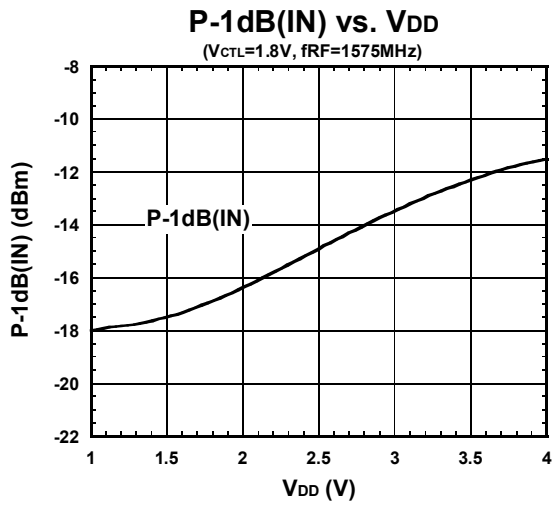

# NJG1157PCD

## APPLICATION CIRCUIT

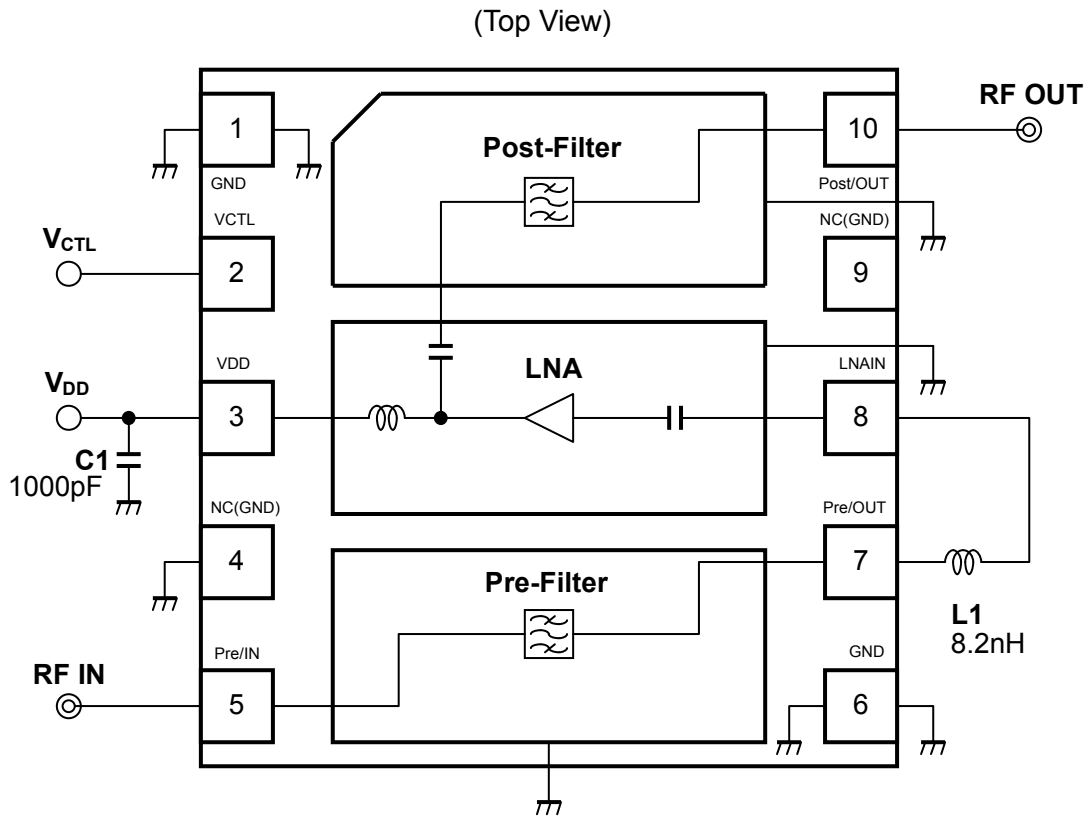

### Parts list

| Parts ID | Manufacture               |
|----------|---------------------------|
| L1       | LQW15A Series<br>(MURATA) |
| C1       | GRM03 Series<br>(MURATA)  |





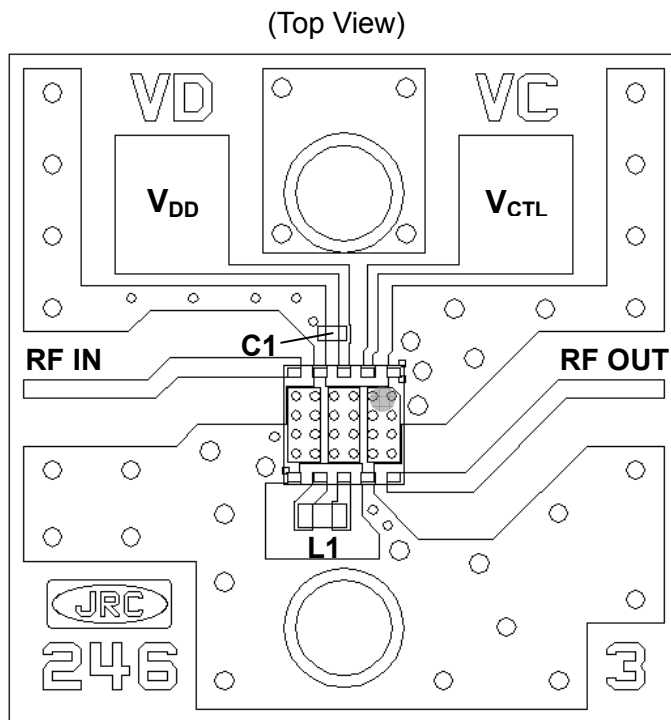

## ■ Evaluation board

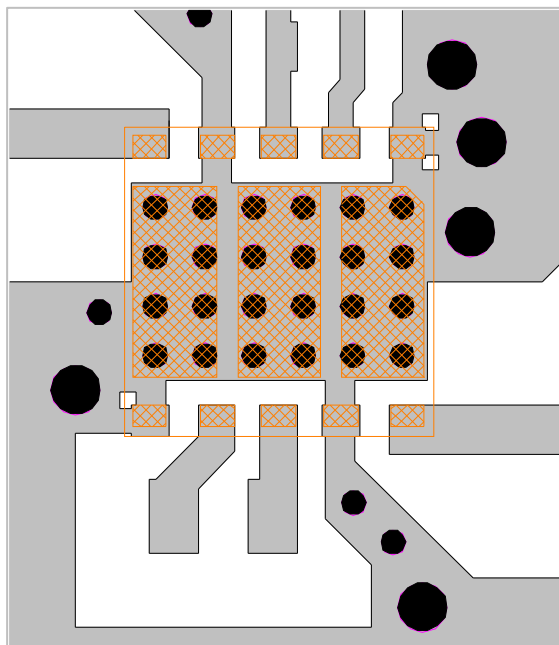

PCB  
 Substrate: FR-4  
 Thickness: 0.2mm  
 Microstrip line width: 0.4mm ( $Z_0=50\Omega$ )  
 Size: 14.0mm x 14.0mm

## <PCB LAYOUT GUIDELINE>



-  PCB
-  PKG Terminal
-  PKG Outline
-  GND Via Hole  
Diameter  $\phi=0.2\text{mm}, 0.4\text{mm}$



## PRECAUTIONS

- Please layout ground pattern under this FEM in order not to couple with RFIN and RFOUT terminal.
- All external parts should be placed as close as possible to the FEM.
- For good RF performance, all GND terminals must be connected to PCB ground plane of substrate, and via-holes for GND should be placed near the FEM.

# NJG1157PCD

## RECOMMENDED FOOTPRINT PATTERN (HFFP10-CD PACKAGE) <Reference>

PKG : 2.5mm x 2.5mm

-  : Land
-  :Mask (Open area) \*Metal mask thickness : 100μm
-  :Resist(Open area)

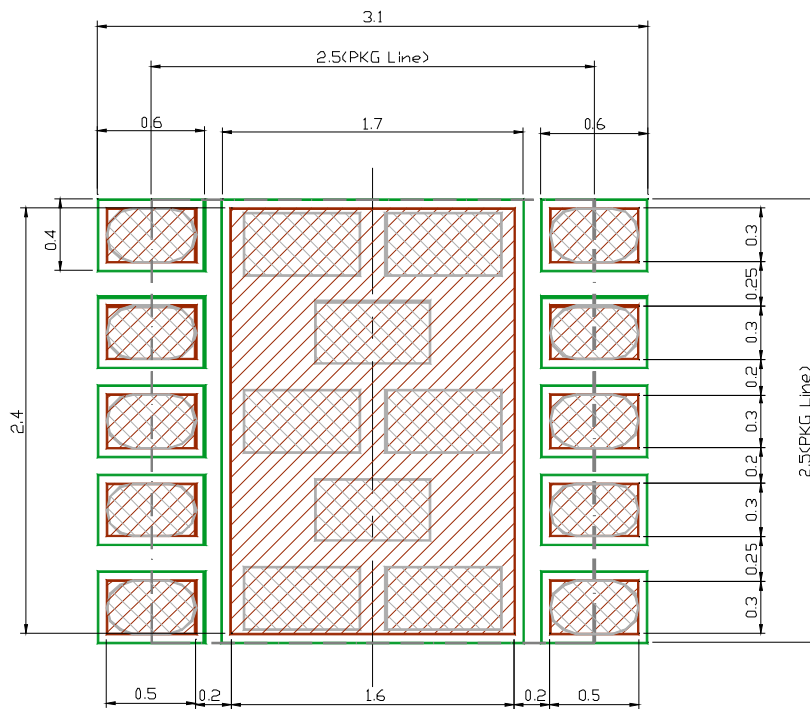

### Metal MASK Detail

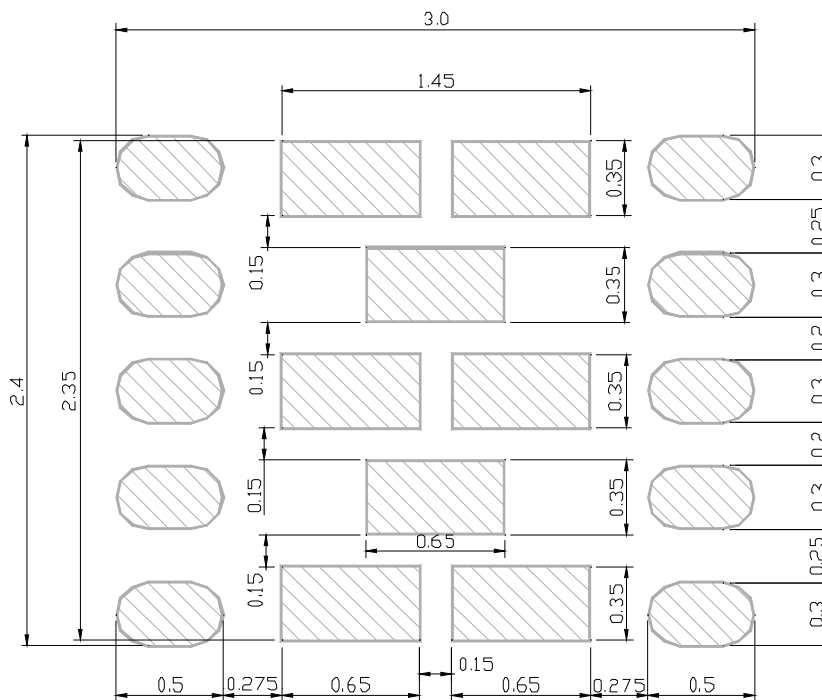

■ NOISE FIGURE MEASUREMENT BLOCK DIAGRAM

Measuring instruments

NF Analyzer : Agilent N8973A  
Noise Source : Agilent 346A

Setting the NF analyzer

Measurement mode form  
Device under test : Amplifier  
System downconverter : off  
Mode setup form  
Sideband : LSB  
Averages : 16  
Average mode : Point  
Bandwidth : 4MHz  
Loss comp : off  
Tcold : setting the temperature of noise source (303.15K)

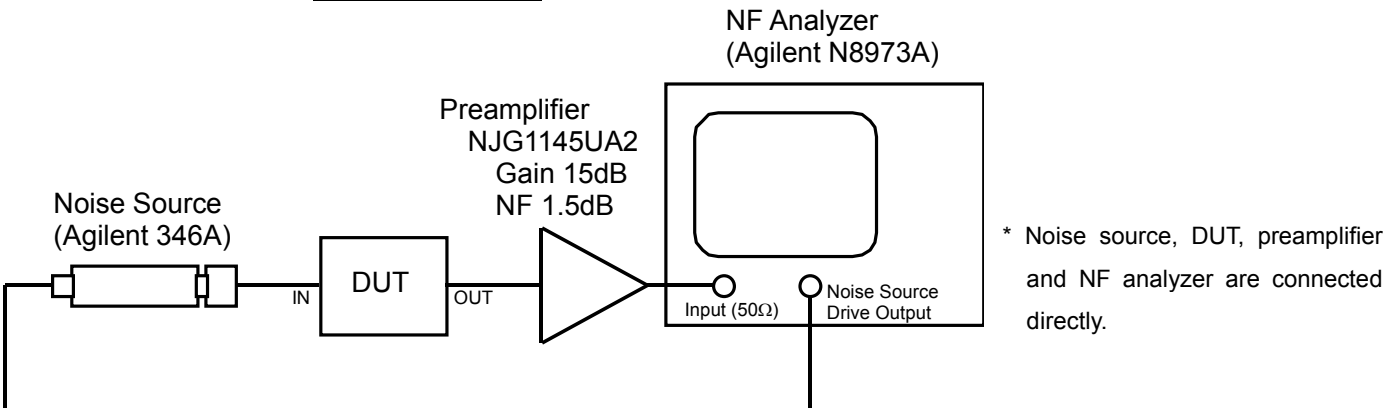
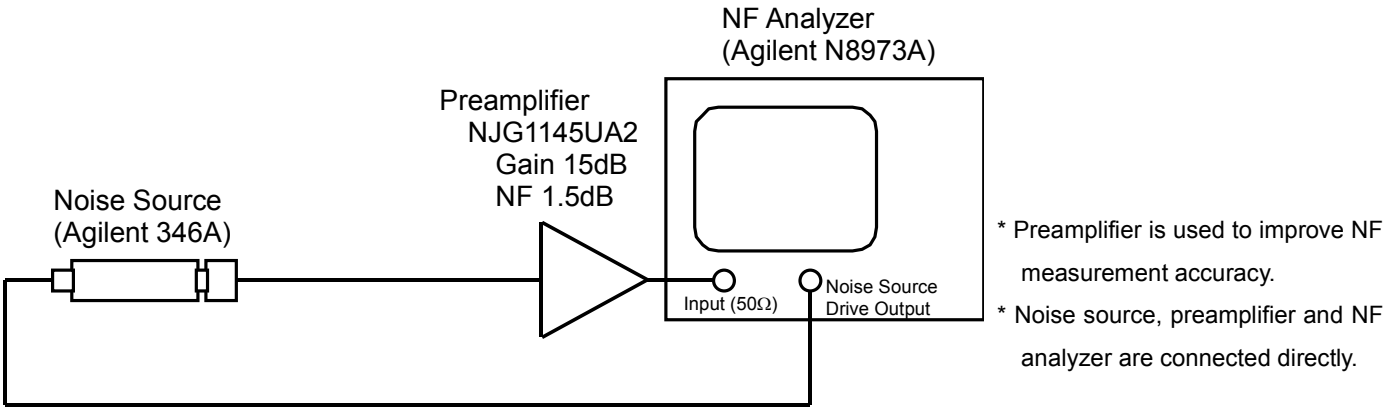

# NJG1157PCD

## PACKAGE OUTLINE (HFFP10-CD)

TOP VIEW

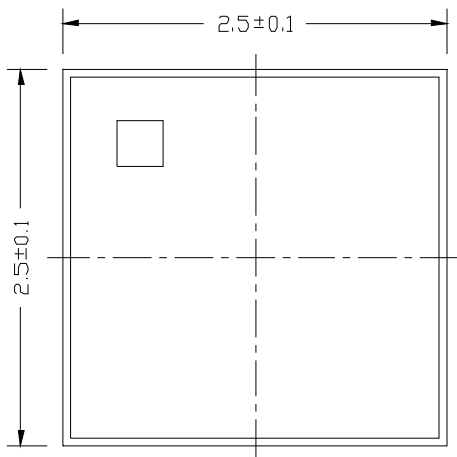

SIDE VIEW

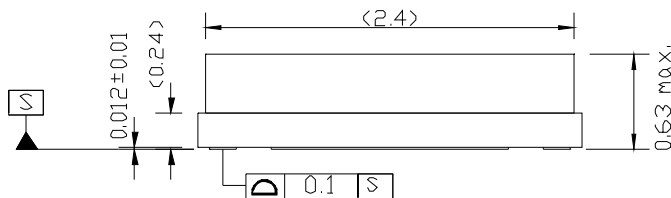

BOTTOM VIEW

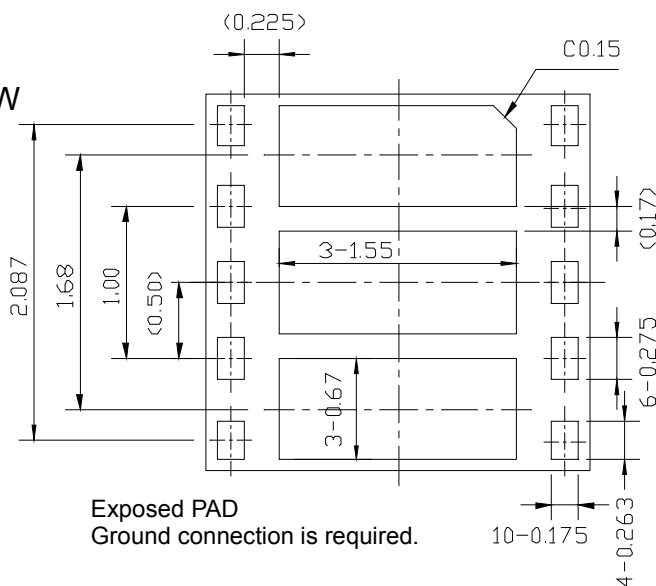

Package Size : 2.5±0.1mm  
0.63mm max.  
Electrode Dimensions clearance : ±0.05mm

Unit : mm  
Substrate : Ceramic  
Terminal treat : Au  
Lid : SnAg/Kovar/Ni  
Weight (typ.) : 18.00mg

### Cautions on using this product

This product contains Gallium-Arsenide (GaAs) which is a harmful material.

- Do NOT eat or put into mouth.
- Do NOT dispose in fire or break up this product.
- Do NOT chemically make gas or powder with this product.
- To waste this product, please obey the relating law of your country.

### [CAUTION]

The specifications on this databook are only given for information, without any guarantee as regards either mistakes or omissions. The application circuits in this databook are described only to show representative usages of the product and not intended for the guarantee or permission of any right including the industrial rights.

This product may be damaged with electric static discharge (ESD) or spike voltage. Please handle with care to avoid these damages.

This product is hollow seal package type, and it is with the structure susceptible to stress from the outside. Therefore, note the following in relation to the contents, after conducting an evaluation, please use.

1. After mounting this product, to implement the potting and transfer molding, please the confirmation of resistance to temperature changes and shrinkage stress involved in the molding.
2. When mounted on the product, collet diameter please use more than 1mmφ. In addition, the value of static load is recommended mounting less than 5N.
3. For dynamic load at the time of mounting, please use it after confirming in consideration of the contact area / speed / load.