

# DLPC3439 Display Controller

## 1 Features

- Display controller for [DLP4710](#) (.47 1080p) DMD
  - Two DLPC3439 controllers drive the DLP4710 DMD
  - Supports input image sizes up to 1080p
  - Low-power DMD interface with interface training
- Input frame rates Up to 120 Hz (60 Hz at 1080p resolution)
- Pixel data processing:
  - IntelliBright™ suite of image processing algorithms
    - Content adaptive illumination control (CAIC)
    - Local area brightness boost (LABB)
  - Image resizing (scaling)
  - Color coordinate adjustment
  - Programmable degamma
  - Active power management processing
  - Color space conversion
  - 4:2:2 to 4:4:4 chroma interpolation
- 24-Bit, input pixel interface support:
  - Parallel Interface Protocol
  - Pixel clock up to 155 MHz
  - Multiple input pixel data format options
- External flash support
- Auto DMD parking at power down
- Embedded frame memory (eDRAM)
- System features:
  - I<sup>2</sup>C control of device configuration
  - Programmable splash screens
  - Programmable LED current control
  - One frame latency
- Pair with [DLPA3000](#) or [DLPA3005](#) PMIC (power management integrated circuit) and LED driver

## 2 Applications

- [DLP Signage](#)
- [Mobile Projector](#)
- [Mobile Smart TV](#)
- [Smart home displays](#)
- [Pico projectors](#)

## 3 Description

The [DLPC3439](#) digital controller, part of the [DLP4710](#) (.47 1080p) chipset, supports reliable operation of the DLP4710 digital micromirror device (DMD). The DLPC3439 controller provides a convenient, multifunctional interface between system electronics and the DMD, enabling small form factor, low power, and high resolution full HD displays.

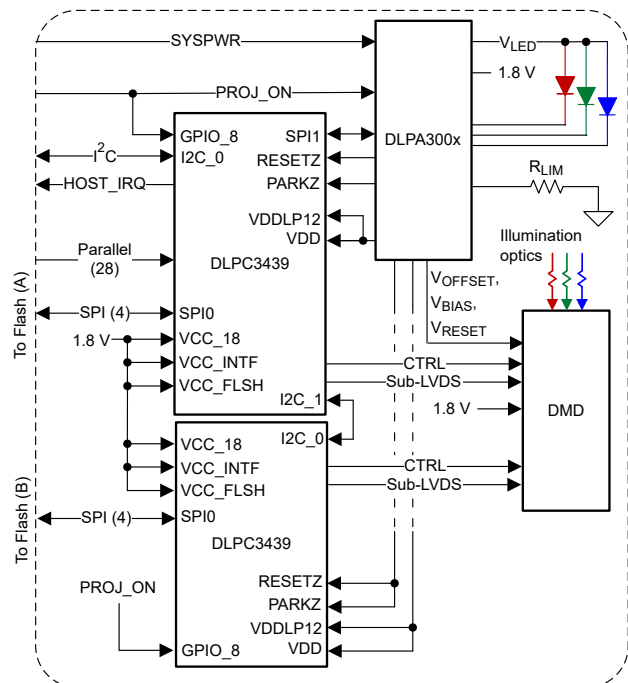
Visit the [getting started with TI DLP®Pico™ display technology page](#), and view the [programmer's guide](#) to learn how to get started.

The chipsets include established resources to help the user accelerate the design cycle, which include [production ready optical modules](#), [optical module manufacturers](#), and [design houses](#).

### Device Information (1)

PART NUMBER	PACKAGE	BODY SIZE (NOM)
DLPC3439	NFBGA (201)	13.00 × 13.00 mm <sup>2</sup>

- (1) For all available packages, see the orderable addendum at the end of the data sheet.



**Typical, Simplified System**



## Table of Contents

<b>1 Features</b> .....	1	7.1 Overview.....	29
<b>2 Applications</b> .....	1	7.2 Functional Block Diagram.....	29
<b>3 Description</b> .....	1	7.3 Feature Description.....	30
<b>4 Revision History</b> .....	3	7.4 Device Functional Modes.....	44
<b>5 Pin Configuration and Functions</b> .....	6	7.5 Programming.....	44
<b>6 Specifications</b> .....	14	<b>8 Application and Implementation</b> .....	45
6.1 Absolute Maximum Ratings.....	14	8.1 Application Information.....	45
6.2 ESD Ratings.....	14	8.2 Typical Application.....	45
6.3 Recommended Operating Conditions.....	15	<b>9 Power Supply Recommendations</b> .....	48
6.4 Thermal Information.....	15	9.1 PLL Design Considerations.....	48
6.5 Power Electrical Characteristics.....	16	9.2 System Power-Up and Power-Down Sequence.....	48
6.6 Pin Electrical Characteristics.....	17	9.3 Power-Up Initialization Sequence.....	52
6.7 Internal Pullup and Pulldown Electrical Characteristics.....	19	9.4 DMD Fast Park Control (PARKZ).....	52
6.8 DMD Sub-LVDS Interface Electrical Characteristics.....	20	9.5 Hot Plug I/O Usage.....	53
6.9 DMD Low-Speed Interface Electrical Characteristics.....	21	<b>10 Layout</b> .....	54
6.10 System Oscillator Timing Requirements.....	23	10.1 Layout Guidelines.....	54
6.11 Power Supply and Reset Timing Requirements.....	24	10.2 Layout Example.....	62
6.12 Parallel Interface Frame Timing Requirements.....	25	<b>11 Device and Documentation Support</b> .....	63
6.13 Parallel Interface General Timing Requirements.....	26	11.1 Device Support.....	63
6.14 Flash Interface Timing Requirements.....	27	11.2 Related Documentation.....	65
6.15 Other Timing Requirements.....	28	11.3 Related Links.....	65
6.16 DMD Sub-LVDS Interface Switching Characteristics.....	28	11.4 Receiving Notification of Documentation Updates..	65
6.17 DMD Parking Switching Characteristics.....	28	11.5 Support Resources.....	65
6.18 Chipset Component Usage Specification.....	28	11.6 Trademarks.....	65
<b>7 Detailed Description</b> .....	29	11.7 Electrostatic Discharge Caution.....	65
		11.8 Glossary.....	65
		<b>12 Mechanical, Packaging, and Orderable Information</b> .....	66
		12.1 Package Option Addendum.....	67

## 4 Revision History

NOTE: Page numbers for previous revisions may differ from page numbers in the current version.

<b>Changes from Revision D (June 2019) to Revision E (February 2021)</b>	<b>Page</b>
• Updated the numbering format for tables, figures, and cross-references throughout the document.....	1
• General datasheet formatting and ordering refresh .....	1
• Deleted mention of mirror parking time from PARKZ pin description and moved to a specification table.....	6
• Changed JTAG pin names from Reserved to proper names .....	6
• Deleted support for adjustable DATAEN_CMD polarity .....	6
• Deleted mention of a specific 3D command .....	6
• Deleted support for adjusting PCLK capture edge in software .....	6
• Changed the description of how to use the CMP_OUT pin and corrected how the comparator must use GPIO_10 (RC_CHARGE) instead of CMP_PWM .....	6
• Deleted support for CMP_PWM.....	6
• Added note about VCC_INTF power up recommendations if slave devices are on the I <sup>2</sup> C bus .....	6
• Deleted mention of unsupported light sensor on GPIO_13 and GPIO_12 .....	6
• Deleted reference of the RC_CHARGE circuit being used for the light sensor and added reference of it being used for the thermistor .....	6
• Deleted reference of the LS_PWR circuit being used for the light sensor.....	6
• Deleted mention of the unsupported LABB output sample and hold sensor control signal.....	6
• Clarified GPIO_03 - GPIO_01 pins are required to be used as a SPI1 port.....	6
• Deleted misleading note about GPIO pins defaulting to inputs .....	6
• Added missing I/O definition 10 .....	6
• Deleted unneeded VCC_INTF and VCC_FLSH absolute maximum values .....	14
• Added high voltage tolerant note to Absolute Maximum Ratings table .....	14
• Changed incorrect pin tolerance .....	15
• Changed Power Electrical Characteristics table to reflect updated power measurement values and techniques .....	16
• Deleted reference to unsupported IDLE mode .....	16
• Added note that the power numbers vary depending on the utilized software.....	16
• Changed and fixed incorrect test conditions for current drive strengths.....	17
• Deleted redundant  V <sub>OD</sub>   specification which is referenced in later sections.....	17
• Added minimum and maximum values for V <sub>OH</sub> for I/O type 4.....	17
• Added minimum and maximum values for V <sub>OL</sub> for I/O type 4.....	17
• Deleted incorrect reference to 2.5V, 24mA drive .....	17
• Corrected I <sup>2</sup> C buffer test conditions.....	17
• Deleted incorrect steady-state common mode voltage reference .....	17
• Changed high voltage tolerant I/O note to only refer to the I <sup>2</sup> C buffer and changed VCC to VCC_INTF.....	17
• Added  V <sub>OD</sub>   minimum and maximum values, and changed the typical value.....	20
• Added high-level output voltage minimum and maximum values for the sub-LVDS DMD interface, deleted redundant mention of specification, and changed the typical value. ....	20
• Added low-level output voltage minimum and maximum values for the sub-LVDS DMD interface, deleted redundant mention of specification, and changed the typical value. ....	20
• Corrected the name of the DMD Low-Speed signals from inputs to outputs. ....	21
• Deleted V <sub>OH(DC)</sub> maximum and V <sub>OL(DC)</sub> minimum values. ....	21
• Added note about DMD input specs being met if a proper series termination resistor is used .....	21
• Deleted reference of selecting unsupported oscillator frequency .....	23
• Corrected system oscillator clock period to match clock frequency .....	23
• Changed pulse duration percent spec from a maximum to a minimum .....	23

• Added condition for VDD rise time .....	24
• Deleted the incorrect part of the $t_{p\_tvb}$ definition.....	25
• Deleted unneeded total horizontal blanking equation .....	25
• Changed minimum total vertical blanking equation .....	25
• Increased maximum PCLK from 150MHz to 155MHz .....	26
• Deleted reference to various signal's active edges being configurable .....	26
• Changed the minimum flash SPI_CLK frequency.....	27
• Corrected flash interface clock period to match clock frequency .....	27
• Added <a href="#">Section 6.15</a> section to more clearly list signal transition time requirements.....	28
• Changed DMD HS Clock switching rate from maximum to nominal and added accompanying clock specification .....	28
• Added <a href="#">Section 6.17</a> section.....	28
• Added the <a href="#">Section 6.18</a> section to clarify chipset support requirements.....	28
• Deleted reference to internal software tools and clarified how firmware affects the supported resolution and frame rates .....	30
• Clarified note about VSYNC_WE needing to remain active .....	31
• Deleted support for changing the clock active edge and clarified support of changing the sync active edge..	31
• Changed the DATAEN_CMD signal to not be optional .....	31
• Added information that the parallel interface isn't ready to accept data until the auto-initialization process is completed.....	34
• Changed how the 500 ms startup time is described .....	34
• Changed SPI flash key timing parameter access frequency minimum and maximum values.....	34
• Changed maximum flash size supported from 16Mb to 128Mb .....	34
• Deleted SPI signal routing section .....	36
• Deleted support for a light sensor integrated with the DLPC34xx controller .....	38
• Added missing timing definitions .....	39
• Clarified that the mentioned SDR clock speed is the typical value.....	42
• Changed how the DMD Sub-LVDS Interface requirements are mentioned .....	42
• Deleted DMD Interface stack-up image .....	42
• Deleted equation concerning DMD interface system timing margin .....	42
• Changed the description of how PROJ_ON affects the power supplies .....	46
• Changed which signals are listed as tri-stated at power up and which signals are pulled low .....	52
• Changed 1-oz copper plane recommendation .....	54
• Deleted reference to unsupported option of variable frequency reference clock.....	55
• Added additional DMD data and DMD clock signal matching requirements .....	58
• Changed maximum mismatch from $\pm 0.1''$ to $\pm 1.0''$ .....	58
• Changed incorrect signal matching requirement table note.....	58
• Changed differential signal layer change to a recommendation.....	60
• Changed wording requiring no more than two vias on certain DMD signals .....	60
• Changed device markings image and definitions .....	63

---

<b>Changes from Revision C (December 2016) to Revision D (June 2019)</b>		<b>Page</b>
• Changed mirror parking time from "500 $\mu$ s" to "20 ms" for PARKZ description in <i>Pin Functions</i> table.....		6
<b>Changes from Revision B (January 2016) to Revision C (December 2016)</b>		<b>Page</b>
• Updated $V_{(VCC18)}$ maximum from 18 mA to 62 mA in <a href="#">Section 6.5</a> .....		16
• Updated $V_{(VCC18)} + V_{(VCC\_INTF)} + V_{(VCC\_FLSH)}$ maximum from 22.5 mA to 66.5 mA in <a href="#">Section 6.5</a> .....		16
• Modified description in <a href="#">Section 7.1</a> to account for two DLPC3439 controllers.....		29
• Included additional DLPC3439 compatible SPI flash device options in <a href="#">Table 7-6</a> .....		34
• Added <a href="#">Section 7.3.7</a> .....		39
• Updated <a href="#">Section 11.1.2.1</a> image, changed manufacturing site to generic code.....		63
• In <a href="#">Section 11.1.2.1</a> note, updated link for DLPC3439 resolutions on the DMD supported per part number to refer to <a href="#">Table 7-1</a> .....		63
• Added DLPA3000 to Chipset Documentation table.....		65
• Added MSL Peak Temp to <a href="#">Section 12.1.1</a> .....		67
<b>Changes from Revision A (June 2015) to Revision B (January 2016)</b>		<b>Page</b>
• Corrected device markings .....		63
• Updated image and table .....		63
<b>Changes from Revision * (February 2014) to Revision A (September 2014)</b>		<b>Page</b>
• Updated <a href="#">Section 11.1.2.1</a> image and table.....		63

## 5 Pin Configuration and Functions

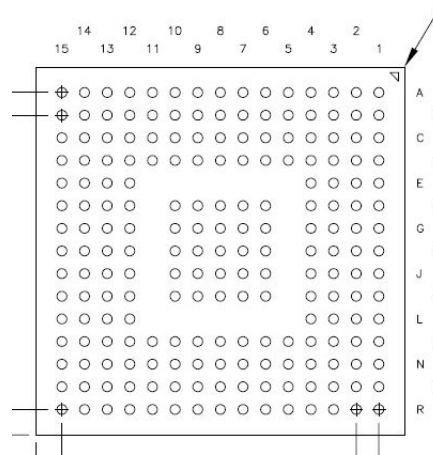


Figure 5-1. ZEZ Package 201-Pin NFBGA Bottom View

	1	2	3	4	5	6	7	8	9	10	11	12	13	14	15
A	DMD_LS_CLK	DMD_LS_WDATA	DMD_HS_WDATAH_P	DMD_HS_WDATAG_P	DMD_HS_WDATAF_P	DMD_HS_WDATAE_P	DMD_HS_CLK_P	DMD_HS_WDATAD_P	DMD_HS_WDATAC_P	DMD_HS_WDATAB_P	DMD_HS_WDATAA_P	CMP_OUT	SPI0_CLK	SPI0_CS20	CMP_PWM
B	DMD_DEN_ARSTZ	DMD_LS_RDATA	DMD_HS_WDATAH_N	DMD_HS_WDATAG_N	DMD_HS_WDATAF_N	DMD_HS_WDATAE_N	DMD_HS_CLK_N	DMD_HS_WDATAD_N	DMD_HS_WDATAC_N	DMD_HS_WDATAB_N	DMD_HS_WDATAA_N	SPI0_DIN	SPI0_DOUT	LED_SEL_1	LED_SEL_0
C	DD3P	DD3N	VDDL12	VSS	VDD	VSS	VCC	VSS	VCC	HWTEST_EN	RESETZ	SPI0_CS21	PARKZ	GPIO_00	GPIO_01
D	DD2P	DD2N	VDD	VCC	VDD	VSS	VDD	VSS	VDD	VSS	VCC_FLSH	VDD	VDD	GPIO_02	GPIO_03
E	DCLKP	DCLKN	VDD	VSS								VCC	VSS	GPIO_04	GPIO_05
F	DD1P	DD1N	RREF	VSS		VSS	VSS	VSS	VSS	VSS		VCC	VDD	GPIO_06	GPIO_07
G	DD0P	DD0N	VSS_PLLM	VSS		VSS	VSS	VSS	VSS	VSS		VSS	VSS	GPIO_08	GPIO_09
H	PLL_REFCLK_I	VDD_PLLM	VSS_PLLD	VSS		VSS	VSS	VSS	VSS	VSS		VSS	VDD	GPIO_10	GPIO_11
J	PLL_REFCLK_O	VDD_PLLD	VSS	VDD		VSS	VSS	VSS	VSS	VSS		VDD	VSS	GPIO_12	GPIO_13
K	PDATA_1	PDATA_0	VDD	VSS		VSS	VSS	VSS	VSS	VSS		VSS	VCC	GPIO_14	GPIO_15
L	PDATA_3	PDATA_2	VSS	VDD								VDD	VDD	GPIO_16	GPIO_17
M	PDATA_5	PDATA_4	VCC_INTF	VSS	VSS	VDD	VCC_INTF	VSS	VDD	VDD	VCC	VSS	JTAGTMS1	GPIO_18	GPIO_19
N	PDATA_7	PDATA_6	VCC_INTF	PDM_CVS_TE	HSYNC_CS	3DR	VCC_INTF	HOST_IRQ	IIC0_SDA	IIC0_SCL	JTAGTMS2	JTAGTDO2	JTAGTDO1	TSTPT_6	TSTPT_7
P	VSYNC_WE	DATEN_CMD	PCLK	PDATA_11	PDATA_13	PDATA_15	PDATA_17	PDATA_19	PDATA_21	PDATA_23	JTAGTRSTZ	JTAGTCK	JTAGTDI	TSTPT_4	TSTPT_5
R	PDATA_8	PDATA_9	PDATA_10	PDATA_12	PDATA_14	PDATA_16	PDATA_18	PDATA_20	PDATA_22	IIC1_SDA	IIC1_SCL	TSTPT_0	TSTPT_1	TSTPT_2	TSTPT_3

Note: The lower image view is from the top.

Figure 5-2. 13 mm × 13 mm Package – VF Ball Grid Array

**Table 5-1. Test Pins and General Control**

PIN		I/O	TYPE <sup>(4)</sup>	DESCRIPTION
NAME	NO.			
HWTEST_EN	C10	I	6	Manufacturing test enable signal. Connect this signal directly to ground on the PCB for normal operation.
PARKZ	C13	I	6	DMD fast park control (active low Input with a hysteresis buffer). This signal is used to quickly park the DMD when loss of power is imminent. The longest lifetime of the DMD may not be achieved with the fast park operation; therefore, this signal is intended to only be asserted when a normal park operation is unable to be completed. The PARKZ signal is typically provided from the DLPAXxxx interrupt output signal.
JTAGTCK	P12	I	6	TI internal use. Leave this pin unconnected.
JTAGTDI	P13	I	6	TI internal use. Leave this pin unconnected.
JTAGTDO1	N13 <sup>(1)</sup>	O	1	TI internal use. Leave this pin unconnected.
JTAGTDO2	N12 <sup>(1)</sup>	O	1	TI internal use. Leave this pin unconnected.
JTAGTMS1	M13	I	6	TI internal use. Leave this pin unconnected.
JTAGTMS2	N11	I	6	TI internal use. Leave this pin unconnected.
JTAGTRSTZ	P11	I	6	TI internal use. This pin must be tied to ground, through an external resistor for normal operation. Failure to tie this pin low during normal operation can cause start up and initialization problems. <sup>(2)</sup>
RESETZ	C11	I	6	Power-on reset (active low input with a hysteresis buffer). Self-configuration starts when a low-to-high transition is detected on RESETZ. All controller power and clocks must be stable before this reset is de-asserted. No signals are in their active state while RESETZ is asserted. This pin is typically connected to the RESET_Z pin of the DLPA300x.
TSTPT_0	R12	I/O	1	Test pins (includes weak internal pulldown). Pins are tri-stated while RESETZ is asserted low. Sampled as an input test mode selection control approximately 1.5 μs after de-assertion of RESETZ, and then driven as outputs. <sup>(2) (3)</sup> Normal use: reserved for test output. Leave open for normal use. Note: An external pullup may put the DLPC34xx in a test mode. See <a href="#">Section 7.3.8</a> for more information.
TSTPT_1	R13	I/O	1	
TSTPT_2	R14	I/O	1	
TSTPT_3	R15	I/O	1	
TSTPT_4	P14	I/O	1	
TSTPT_5	P15	I/O	1	
TSTPT_6	N14	I/O	1	
TSTPT_7	N15	I/O	1	

- (1) If the application design does not require an external pullup, and there is no external logic that can overcome the weak internal pulldown resistor, then this I/O pin can be left open or unconnected for normal operation. If the application design does not require an external pullup, but there is external logic that might overcome the weak internal pulldown resistor, then an external pullup is recommended to ensure a logic low.
- (2) External resistor must have a value of 8 kΩ or less to compensate for pins that provide internal pullup or pulldown resistors.
- (3) If the application design does not require an external pullup and there is no external logic that can overcome the weak internal pulldown, then the TSTPT I/O can be left open (unconnected) for normal operation. If operation does not call for an external pullup, but there is external logic that might overcome the weak internal pulldown resistor, then an external pulldown resistor is recommended to ensure a logic low.
- (4) See [Table 5-10](#) for type definitions.

**Table 5-2. Parallel Port Input (1) (2)**

PIN		I/O	Type <sup>(4)</sup>	DESCRIPTION
NAME	NO.			PARALLEL RGB MODE
PCLK	P3	I	10	Pixel clock
PDM_CVS_TE	N4	I/O	5	Parallel data mask. Programmable polarity with default of active high. Optional signal.
VSYNC_WE	P1	I	10	Vsync <sup>(3)</sup>
HSYNC_CS	N5	I	10	Hsync <sup>(3)</sup>
DATAEN_CMD	P2	I	10	Data valid
PDATA_0 PDATA_1 PDATA_2 PDATA_3 PDATA_4 PDATA_5 PDATA_6 PDATA_7	K2 K1 L2 L1 M2 M1 N2 N1	I	10	<b>(TYPICAL RGB 888)</b> Blue (bit weight 1) Blue (bit weight 2) Blue (bit weight 4) Blue (bit weight 8) Blue (bit weight 16) Blue (bit weight 32) Blue (bit weight 64) Blue (bit weight 128)
PDATA_8 PDATA_9 PDATA_10 PDATA_11 PDATA_12 PDATA_13 PDATA_14 PDATA_15	R1 R2 R3 P4 R4 P5 R5 P6	I	10	<b>(TYPICAL RGB 888)</b> Green (bit weight 1) Green (bit weight 2) Green (bit weight 4) Green (bit weight 8) Green (bit weight 16) Green (bit weight 32) Green (bit weight 64) Green (bit weight 128)
PDATA_16 PDATA_17 PDATA_18 PDATA_19 PDATA_20 PDATA_21 PDATA_22 PDATA_23	R6 P7 R7 P8 R8 P9 R9 P10	I	10	<b>(TYPICAL RGB 888)</b> Red (bit weight 1) Red (bit weight 2) Red (bit weight 4) Red (bit weight 8) Red (bit weight 16) Red (bit weight 32) Red (bit weight 64) Red (bit weight 128)
3DR	N6	I	10	3D reference <ul style="list-style-type: none"> <li>For 3D applications: left or right 3D reference (left = 1, right = 0). To be provided by the host. Must transition in the middle of each frame (no closer than 1 ms to the active edge of VSYNC)</li> <li>If a 3D application is not used, pull this input low through an external resistor.</li> </ul>

- (1) PDATA(23:0) bus mapping depends on pixel format and source mode. See later sections for details.  
(2) Connect unused inputs to ground or pulldown to ground through an external resistor (8 kΩ or less).  
(3) VSYNC and HSYNC polarity can be adjusted by software.  
(4) See [Table 5-10](#) for type definitions.



**Table 5-3. DSI Input Data and Clock**

PIN		I/O	Type <sup>(1)</sup>	DESCRIPTION
NAME	NO.			
DCLKN	E2			Unused; leave unconnected and floating
DCLKP	E1			
DD0N	G2			
DD0P	G1			
DD1N	F2			
DD1P	F1			
DD2N	D2			
DD2P	D1			
DD3N	C2			
DD3P	C1			
RREF	F3	—		

(1) See [Table 5-10](#) for type definitions.

**Table 5-4. DMD Reset and Bias Control**

PIN		I/O	TYPE <sup>(1)</sup>	DESCRIPTION
NAME	NO.			
DMD_DEN_ARSTZ	B1	O	2	DMD driver enable (active high). DMD reset (active low). When corresponding I/O power is supplied, the controller drives this signal low after the DMD is parked and before power is removed from the DMD. If the 1.8-V power to the DLPC34xx is independent of the 1.8-V power to the DMD, then TI recommends including a weak, external pulldown resistor to hold the signal low in case DLPC34xx power is inactive while DMD power is applied.
DMD_LS_CLK	A1	O	3	DMD, low speed (LS) interface clock
DMD_LS_WDATA	A2	O	3	DMD, low speed (LS) serial write data
DMD_LS_RDATA	B2	I	6	DMD, low speed (LS) serial read data

(1) See [Table 5-10](#) for type definitions.

**Table 5-5. DMD Sub-LVDS Interface**

PIN		I/O	TYPE <sup>(1)</sup>	DESCRIPTION
NAME	NO.			
DMD_HS_CLK_P	A7	O	4	DMD high speed (HS) interface clock
DMD_HS_CLK_N	B7			
DMD_HS_WDATA_H_P	A3	O	4	DMD sub-LVDS high speed (HS) interface write data lanes. The true numbering and application of the DMD_HS_WDATA pins depend on the software configuration. See <a href="#">Table 7-9</a> .
DMD_HS_WDATA_H_N	B3			
DMD_HS_WDATA_G_P	A4			
DMD_HS_WDATA_G_N	B4			
DMD_HS_WDATA_F_P	A5			
DMD_HS_WDATA_F_N	B5			
DMD_HS_WDATA_E_P	A6			
DMD_HS_WDATA_E_N	B6			
DMD_HS_WDATA_D_P	A8			
DMD_HS_WDATA_D_N	B8			
DMD_HS_WDATA_C_P	A9			
DMD_HS_WDATA_C_N	B9			
DMD_HS_WDATA_B_P	A10			
DMD_HS_WDATA_B_N	B10			
DMD_HS_WDATA_A_P	A11			
DMD_HS_WDATA_A_N	B11			

(1) See [Table 5-10](#) for type definitions.

**Table 5-6. Peripheral Interface (1)**

PIN		I/O	TYPE <sup>(3)</sup>	DESCRIPTION
NAME	NO.			
CMP_OUT	A12	I	6	Successive approximation ADC (analog-to-digital converter) comparator output (DLPC34xx Input). To implement, use a successive approximation ADC with a thermistor feeding one input of the external comparator and the DLPC34xx controller GPIO_10 (RC_CHARGE) pin driving the other side of the comparator. It is recommended to use the DLPxxxx to achieve this function. CMP_OUT must be pulled-down to ground if this function is not used. (hysteresis buffer)
CMP_PWM	A15	O	1	TI internal use. Leave this pin unconnected.
HOST_IRQ <sup>(2)</sup>	N8	O	9	Host interrupt (output) HOST_IRQ indicates when the DLPC34xx auto-initialization is in progress and most importantly when it completes. This pin is tri-stated during reset. An external pullup must be included on this signal.
IIC0_SCL <sup>(4)</sup>	N10	I/O	7	I <sup>2</sup> C slave (port 0) SCL (bidirectional, open-drain signal with input hysteresis): This pin requires an external pullup resistor. The slave I <sup>2</sup> C I/Os are 3.6-V tolerant (high-voltage-input tolerant) and are powered by VCC_INTF (which can be 1.8, 2.5, or 3.3 V). External I <sup>2</sup> C pullups must be connected to a host supply with an equal or higher supply voltage, up to a maximum of 3.6 V (a lower pullup supply voltage does not typically satisfy the V <sub>IH</sub> specification of the slave I <sup>2</sup> C input buffers).
IIC1_SCL	R11	I/O	8	TI internal use. TI recommends an external pullup resistor.
IIC0_SDA <sup>(4)</sup>	N9	I/O	7	I <sup>2</sup> C slave (port 0) SDA. (bidirectional, open-drain signal with input hysteresis): This pin requires an external pullup resistor. The slave I <sup>2</sup> C port is the control port of controller. The slave I <sup>2</sup> C I/O pins are 3.6-V tolerant (high-volt-input tolerant) and are powered by VCC_INTF (which can be 1.8, 2.5, or 3.3 V). External I <sup>2</sup> C pullups must be connected to a host supply with an equal or higher supply voltage, up to a maximum of 3.6 V (a lower pullup supply voltage does not typically satisfy the V <sub>IH</sub> specification of the slave I <sup>2</sup> C input buffers).
IIC1_SDA	R10	I/O	8	TI internal use. TI recommends an external pullup resistor.
LED_SEL_0	B15	O	1	LED enable select. Automatically controlled by the DLPC34xx programmable DMD sequence  LED_SEL(1:0)                      Enabled LED 00                                      None 01                                      Red 10                                      Green 11                                      Blue
LED_SEL_1	B14	O	1	The controller drives these signals low when RESETZ is asserted and the corresponding I/O power is supplied. The controller continues to drive these signals low throughout the auto-initialization process. A weak, external pulldown resistor is recommended to ensure that the LEDs are disabled when I/O power is not applied.
SPI0_CLK	A13	O	13	SPI (Serial Peripheral Interface) port 0, clock. This pin is typically connected to the flash memory clock.
SPI0_CSZ0	A14	O	13	SPI port 0, chip select 0 (active low output). This pin is typically connected to the flash memory chip select. TI recommends an external pullup resistor to avoid floating inputs to the external SPI device during controller reset assertion.
SPI0_CSZ1	C12	O	13	SPI port 0, chip select 1 (active low output). This pin typically remains unused. TI recommends an external pullup resistor to avoid floating inputs to the external SPI device during controller reset assertion.
SPI0_DIN	B12	I	12	Synchronous serial port 0, receive data in. This pin is typically connected to the flash memory data out.
SPI0_DOUT	B13	O	13	Synchronous serial port 0, transmit data out. This pin is typically connected to the flash memory data in.

(1) External pullup resistor must be 8 kΩ or less.

(2) For more information about usage, see [Section 7.3.2](#).

(3) See [Table 5-10](#) for type definitions.

- (4) When VCC\_INTF is powered and VDD is not powered, the controller may drive the IIC0\_xxx pins low which prevents communication on this I<sup>2</sup>C bus. Do not power up the VCC\_INTF pin before powering up the VDD pin for any system that has additional slave devices on this bus.

**Table 5-7. GPIO Peripheral Interface (1)**

PIN		I/O	TYPE <sup>(1)</sup>	DESCRIPTION <sup>(2)</sup>
NAME	NO.			
GPIO_19	M15	I/O	1	HBT_ODAT (Output): Required to be connected to the second DLPC3439 controller's HBT_IDAT (GPIO_17) input pin.
GPIO_18	M14	I/O	1	HBT_OCLK (Output): Required to be connected to the second DLPC3439 controller's HBT_ICLK (GPIO_16) input pin
GPIO_17	L15	I/O	1	HBT_IDAT (Input): Required to be connected to the second DLPC3439 controller's HBT_ODAT (GPIO_19) output pin
GPIO_16	L14	I/O	1	HBT_ICLK (Input): Required to be connected to the second DLPC3439 controller's HBT_OCLK (GPIO_18) output pin.
GPIO_15	K15	I/O	1	DA_SYNC (BiDir): Required to be connected to the second DLPC3439 controller's DA_SYNC (GPIO_15) pin.
GPIO_14	K14	I/O	1	SEQ_SYNC (BiDir): Required to be connected to the second DLPC3439 controller's SEQ_SYNC (GPIO_14) pin with a 7.87k pullup resistor to VCC18.
GPIO_13	J15	I/O	1	General purpose I/O 13 (hysteresis buffer). Optional GPIO. If unused TI recommends this pin be configured as a logic zero GPIO output and left unconnected. Otherwise this pin requires an external pullup or pulldown to avoid a floating GPIO input.
GPIO_12	J14	I/O	1	General purpose I/O 12 (hysteresis buffer). Optional GPIO. If unused TI recommends this pin be configured as a logic zero GPIO output and left unconnected. Otherwise this pin requires an external pullup or pulldown to avoid a floating GPIO input.
GPIO_11	H15	I/O	1	General purpose I/O 11 (hysteresis buffer). Options: 1. Thermistor power enable (output). Turns on the power to the thermistor when it is used and enabled. 2. Optional GPIO. If unused TI recommends this pin be configured as a logic zero GPIO output and left unconnected. Otherwise this pin requires an external pullup or pulldown to avoid a floating GPIO input.
GPIO_10	H14	I/O	1	General Purpose I/O 10 (hysteresis buffer). Options: 1. RC_CHARGE (output): Intended to feed the RC charge circuit of the thermistor interface. 2. Optional GPIO. If unused TI recommends this pin be configured as a logic zero GPIO output and left unconnected. Otherwise this pin requires an external pullup or pulldown to avoid a floating GPIO input.
GPIO_09	G15	I/O	1	General purpose I/O 09 (hysteresis buffer). Optional GPIO. If unused TI recommends this pin be configured as a logic zero GPIO output and left unconnected. Otherwise this pin requires an external pullup or pulldown to avoid a floating GPIO input.
GPIO_08	G14	I/O	1	General purpose I/O 08 (hysteresis buffer). Normal mirror parking request (active low): To be driven by the PROJ_ON output of the host. A logic low on this signal causes the DLPC34xx to PARK the DMD, but it does not power down the DMD (the DLPxxxx does that instead). The minimum high time is 200 ms. The minimum low time is 200 ms.
GPIO_07	F15	I/O	1	General purpose I/O 07 (hysteresis buffer). If unused TI recommends this pin be configured as a logic zero GPIO output and left unconnected. Otherwise this pin requires an external pullup or pulldown to avoid a floating GPIO input.
GPIO_06	F14	I/O	1	General purpose I/O 06 (hysteresis buffer). Optional GPIO. If unused TI recommends this pin be configured as a logic zero GPIO output and left unconnected. Otherwise this pin requires an external pullup or pulldown to avoid a floating GPIO input.
GPIO_05	E15	I/O	1	General purpose I/O 05 (hysteresis buffer). Optional GPIO. If unused TI recommends this pin be configured as a logic zero GPIO output and left unconnected. Otherwise this pin requires an external pullup or pulldown to avoid a floating GPIO input.
GPIO_04	E14	I/O	1	MST_SLVZ (Input): Master or slave controller identifier signal (Master = 1, Slave = 0).
GPIO_03	D15	I/O	1	General purpose I/O 03 (hysteresis buffer). SPI1_CSZ0 (active low output): SPI1 chip select 0 signal. This pin is typically connected to the DLPxxxx SPI_CSZ pin. Requires an external pullup resistor to deactivate this signal during reset and auto-initialization processes.
GPIO_02	D14	I/O	1	General purpose I/O 02 (hysteresis buffer). SPI1_DOUT (output): SPI1 data output signal. This pin is typically connected to the DLPxxxx SPI_DIN pin.

**Table 5-7. GPIO Peripheral Interface <sup>(1)</sup> (continued)**

PIN		I/O	TYPE <sup>(1)</sup>	DESCRIPTION <sup>(2)</sup>
NAME	NO.			
GPIO_01	C15	I/O	1	General purpose I/O 01 (hysteresis buffer). SPI1_CLK (output): SPI1 clock signal. This pin is typically connected to the DLPxxxx SPI_CLK pin.
GPIO_00	C14	I/O	1	General purpose I/O 00 (hysteresis buffer). SPI1_DIN (input): SPI1 data input signal. This pin is typically connected to the DLPxxxx SPI_DOUT pin.

- (1) GPIO pins must be configured through software for input, output, bidirectional, or open-drain operation. Some GPIO pins have one or more alternative use modes, which are also software configurable. An external pullup resistor is required for each signal configured as open-drain.
- (2) General purpose I/O for the DLPC3439 controller. These GPIO pins are software configurable.

**Table 5-8. Clock and PLL Support**

PIN		I/O	TYPE <sup>(1)</sup>	DESCRIPTION
NAME	NO.			
PLL_REFCLK_I	H1	I	11	Reference clock crystal input. If an external oscillator is used instead of a crystal, use this pin as the oscillator input.
PLL_REFCLK_O	J1	O	5	Reference clock crystal return. If an external oscillator is used instead of a crystal, leave this pin unconnected (floating with no added capacitive load).

- (1) See [Table 5-10](#) for type definitions.

**Table 5-9. Power and Ground**

PIN		I/O	TYPE	DESCRIPTION
NAME	NO.			
VDD	C5, D5, D7, D12, J4, J12, K3, L4, L12, M6, M9, D9, D13, F13, H13, L13, M10, D3, E3	—	PWR	Core 1.1-V power (main 1.1 V)
VDDL12	C3	—	PWR	Reserved – tie to the VDD rail
VSS	C4, D6, D8, D10, E4, E13, F4, G4, G12, H4, H12, J3, J13, K4, K12, L3, M4, M5, M8, M12, G13, C6, C8, F6, F7, F8, F9, F10, G6, G7, G8, G9, G10, H6, H7, H8, H9, H10, J6, J7, J8, J9, J10, K6, K7, K8, K9, K10	—	GND	Core ground (eDRAM, I/O ground, thermal ground)
VCC18	C7, C9, D4, E12, F12, K13, M11	—	PWR	All 1.8-V I/O power: (1.8-V power supply for all I/O pins except the host or parallel interface and the SPI flash interface. This includes RESETZ, PARKZ, LED_SEL, CMP_OUT, GPIO, IIC1, TSTPT, and JTAG pins)
VCC_INTF	M3, M7, N3, N7	—	PWR	Host or parallel interface I/O power: 1.8 V to 3.3 V (Includes IIC0, PDATA, video syncs, and HOST_IRQ pins)

**Table 5-9. Power and Ground (continued)**

PIN		I/O	TYPE	DESCRIPTION
NAME	NO.			
VCC_FLSH	D11	—	PWR	Flash interface I/O power: 1.8 V to 3.3 V (Dedicated SPI0 power pin)
VDD_PLLM	H2	—	PWR	MCG PLL (master clock generator phase lock loop) 1.1-V power
VSS_PLLM	G3	—	RTN	MCG PLL return
VDD_PLLD	J2	—	PWR	DCG PLL (DMD clock generator phase lock loop) 1.1-V power
VSS_PLLD	H3	—	RTN	DCG PLL return

**Table 5-10. I/O Type Subscript Definition**

SUBSCRIPT	I/O		SUPPLY REFERENCE	ESD STRUCTURE
	DESCRIPTION			
1	1.8-V LVCMOS I/O buffer with 8-mA drive		$V_{cc18}$	ESD diode to GND and supply rail
2	1.8-V LVCMOS I/O buffer with 4-mA drive		$V_{cc18}$	ESD diode to GND and supply rail
3	1.8-V LVCMOS I/O buffer with 24-mA drive		$V_{cc18}$	ESD diode to GND and supply rail
4	1.8-V sub-LVDS output with 4-mA drive		$V_{cc18}$	ESD diode to GND and supply rail
5	1.8-V, 2.5-V, 3.3-V LVCMOS with 4-mA drive		$V_{cc\_INTF}$	ESD diode to GND and supply rail
6	1.8-V LVCMOS input		$V_{cc18}$	ESD diode to GND and supply rail
7	1.8-V, 2.5-V, 3.3-V I <sup>2</sup> C with 3-mA drive		$V_{cc\_INTF}$	ESD diode to GND and supply rail
8	1.8-V I <sup>2</sup> C with 3-mA drive		$V_{cc18}$	ESD diode to GND and supply rail
9	1.8-V, 2.5-V, 3.3-V LVCMOS with 8-mA drive		$V_{cc\_INTF}$	ESD diode to GND and supply rail
10	Reserved			
11	1.8-V, 2.5-V, 3.3-V LVCMOS input		$V_{cc\_INTF}$	ESD diode to GND and supply rail
12	1.8-V, 2.5-V, 3.3-V LVCMOS input		$V_{cc\_FLSH}$	ESD diode to GND and supply rail
13	1.8-V, 2.5-V, 3.3-V LVCMOS with 8-mA drive		$V_{cc\_FLSH}$	ESD diode to GND and supply rail

## 6 Specifications

### 6.1 Absolute Maximum Ratings

over operating free-air temperature (unless otherwise noted)<sup>(1)</sup>

		MIN	MAX	UNIT
<b>SUPPLY VOLTAGE<sup>(2)</sup></b>				
V <sub>(VDD)</sub>		-0.3	1.21	V
V <sub>(VDDL12)</sub>		-0.3	1.32	V
V <sub>(VCC18)</sub>		-0.3	1.96	V
DMD Sub-LVDS Interface (DMD_HS_CLK_x and DMD_HS_WDATA_x_y)		-0.3	1.96	V
V <sub>(VCC_INTF)</sub>		-0.3	3.60	V
V <sub>(VCC_FLSH)</sub>		-0.3	3.60	V
V <sub>(VDD_PLLM)</sub> (MCG PLL)		-0.3	1.21	V
V <sub>(VDD_PLLD)</sub> (DCG PLL)		-0.3	1.21	V
V <sub>I2C buffer</sub> (I/O type 7)		-0.3	See <sup>(3)</sup>	V
<b>GENERAL</b>				
T <sub>J</sub>	Operating junction temperature	-30	125	°C
T <sub>stg</sub>	Storage temperature	-40	125	°C

- (1) Stresses beyond those listed under [Section 6.1](#) may cause permanent damage to the device. These are stress ratings only, which do not imply functional operation of the device at these or any other conditions beyond those indicated under [Section 6.3](#). Exposure to absolute-maximum-rated conditions for extended periods may affect device reliability.
- (2) All voltage values are with respect to VSS (GND).
- (3) I/O is high voltage tolerant; that is, if VCC\_INTF = 1.8 V, the input is 3.3-V tolerant, and if VCC\_INTF = 3.3 V, the input is 5-V tolerant.

### 6.2 ESD Ratings

			VALUE	UNIT
V <sub>(ESD)</sub>	Electrostatic discharge	Human body model (HBM), per ANSI/ESDA/JEDEC JS-001, all pins <sup>(1)</sup>	±2000	V
		Charged device model (CDM), per JEDEC specification JESD22-C101, all pins <sup>(2)</sup>	±500	

- (1) JEDEC document JEP155 states that 500-V HBM allows safe manufacturing with a standard ESD control process.
- (2) JEDEC document JEP157 states that 250-V CDM allows safe manufacturing with a standard ESD control process.

## 6.3 Recommended Operating Conditions

over operating free-air temperature range (unless otherwise noted)

		MIN	NOM	MAX	UNIT
V <sub>(VDD)</sub>	Core power 1.1 V (main 1.1 V)	1.045	1.10	1.155	V
V <sub>(VDDL12)</sub>	Reserved See <sup>(3)</sup>	1.045	1.10	1.155	V
V <sub>(VCC18)</sub>	All 1.8-V I/O power: (1.8-V power supply for all I/O pins except the host or parallel interface and the SPI flash interface. This includes RESETZ, PARKZ LED_SEL, CMP_OUT, GPIO, IIC1, TSTPT, and JTAG pins.)	1.64	1.80	1.96	V
V <sub>(VCC_INTF)</sub>	Host or parallel interface I/O power: 1.8 to 3.3 V (includes IIC0, PDATA, video syncs, and HOST_IRQ pins) See <sup>(1)</sup>	1.64	1.80	1.96	V
		2.28	2.50	2.72	
		3.02	3.30	3.58	
V <sub>(VCC_FLSH)</sub>	Flash interface I/O power: 1.8 V to 3.3 V See <sup>(1)</sup>	1.64	1.80	1.96	V
		2.28	2.50	2.72	
		3.02	3.30	3.58	
V <sub>(VDD_PLLM)</sub>	MCG PLL 1.1-V power See <sup>(2)</sup>	1.025	1.100	1.155	V
V <sub>(VDD_PLLD)</sub>	DCG PLL 1.1-V power See <sup>(2)</sup>	1.025	1.100	1.155	V
T <sub>A</sub>	Operating ambient temperature <sup>(4)</sup>	-30		85	°C
T <sub>J</sub>	Operating junction temperature	-30		105	°C

(1) These supplies have multiple valid ranges.

(2) The minimum voltage is lower than other 1.1-V supply minimum to enable additional filtering. This filtering may result in an IR drop across the filter.

(3) VDDL12 must be tied to the VDD rail.

(4) The operating ambient temperature range assumes 0 forced air flow, a JEDEC JESD51 junction-to-ambient thermal resistance value at 0 forced air flow (R<sub>θJA</sub> at 0 m/s), a JEDEC JESD51 standard test card and environment, along with minimum and maximum estimated power dissipation across process, voltage, and temperature. Thermal conditions vary by application, and this affects R<sub>θJA</sub>. Thus, maximum operating ambient temperature varies by application.

- $T_{a\_min} = T_{j\_min} - (P_{d\_min} \times R_{\theta JA}) = -30^{\circ}\text{C} - (0.0\text{ W} \times 28.8^{\circ}\text{C/W}) = -30^{\circ}\text{C}$
- $T_{a\_max} = T_{j\_max} - (P_{d\_max} \times R_{\theta JA}) = +105^{\circ}\text{C} - (0.348\text{ W} \times 28.8^{\circ}\text{C/W}) = +95.0^{\circ}\text{C}$

## 6.4 Thermal Information

THERMAL METRIC <sup>(1)</sup>		DLPC3439	UNIT
		ZEZ (NFBGA)	
		201 PINS	
R <sub>θJC</sub>	Junction-to-case top thermal resistance	10.1	°C/W
R <sub>θJA</sub>	Junction-to-air thermal resistance	at 0 m/s of forced airflow <sup>(2)</sup>	28.8
		at 1 m/s of forced airflow <sup>(2)</sup>	25.3
		at 2 m/s of forced airflow <sup>(2)</sup>	24.4
Ψ <sub>JT</sub>	Temperature variance from junction to package top center temperature, per unit power dissipation <sup>(3)</sup>	0.23	°C/W

(1) For more information about traditional and new thermal metrics, see the *IC Package Thermal Metrics* application report, [SPRA953](#).

(2) Thermal coefficients abide by JEDEC Standard 51. R<sub>θJA</sub> is the thermal resistance of the package as measured using a JEDEC defined standard test PCB. This JEDEC test PCB is not necessarily representative of the DLPC34xx PCB and thus the reported thermal resistance may not be accurate in the actual product application. Although the actual thermal resistance may be different, it is the best information available during the design phase to estimate thermal performance.

(3) Example: (0.5 W) × (0.2 °C/W) ≈ 0.1 °C temperature rise.

## 6.5 Power Electrical Characteristics

over operating free-air temperature range (unless otherwise noted)

PARAMETER <sup>(4) (5) (6)</sup>		TEST CONDITIONS	MIN	TYP <sup>(1)</sup>	MAX <sup>(2)</sup>	UNIT
$I_{(VDD)}$ + $I_{(VDD\_PLL)}$ + $I_{(VDD\_PLL)}$ 1.1V rails		Frame rate = 50 Hz		206	338	mA
		Frame rate = 60 Hz		222	366	
$I_{(VDD\_PLL)}$ MCG PLL 1.1-V current <sup>(3)</sup>		Frame rate = 50 Hz		6		mA
		Frame rate = 60 Hz		6		
$I_{(VDD\_PLL)}$ DCG PLL 1.1-V current <sup>(3)</sup>		Frame rate = 50 Hz		6		mA
		Frame rate = 60 Hz		6		
$I_{(VCC18)}$ All 1.8-V I/O current: (1.8-V power supply for all I/O other than the host or parallel interface and the SPI flash interface)		Frame rate = 50 Hz		31	45	mA
		Frame rate = 60 Hz		31	45	
$I_{(VCC\_INTF)}$ Host or parallel interface I/O current: 1.8 to 3.3 V (includes IIC0, PDATA, video syncs, and HOST_IRQ pins) <sup>(3)</sup>		Frame rate = 50 Hz		2		mA
		Frame rate = 60 Hz		2		
$I_{(VCC\_FLSH)}$ Flash interface I/O current: 1.8 to 3.3 V <sup>(3)</sup>		Frame rate = 50 Hz		1		mA
		Frame rate = 60 Hz		1		

- (1) Values assume all pins using 1.1 V are tied together (including VDDL12), and programmable host and flash I/O are at the minimum nominal voltage (that is 1.8 V).
- (2) Input image is 1920 x 1080 (1080p) 24-bits using VESA reduced blanking v2 timings on the parallel interface at the frame rate shown with the 0.47-inch 1080p (DLP4710) DMD. The controller has the CAIC and LABB algorithms turned off.
- (3) The values do not take into account software updates or customer changes that may affect power performance.
- (4) Assumes nominal process, voltage, and temperature (25°C nominal ambient) with nominal input images.
- (5) Assumes worst case process, maximum voltage, and high nominal ambient temperature of 65°C with worst case input image.
- (6) These power numbers are for a single controller. Two controllers are required in a system and each controller is typically powered by the same source.



## 6.6 Pin Electrical Characteristics

over operating free-air temperature range (unless otherwise noted)

PARAMETER <sup>(3)</sup>		TEST CONDITIONS <sup>(4)</sup>	MIN	TYP	MAX	UNIT	
V <sub>IH</sub>	High-level input threshold voltage	I <sup>2</sup> C buffer (I/O type 7)			0.7 × VCC_INTF	See (1)	V
		I/O type 1, 2, 3, 6, 8 except pins noted in (2)	VCC18 = 1.8 V	1.17		3.6	
		I/O type 1, 6 for pins noted in (2)	VCC18 = 1.8 V	1.3		3.6	
		I/O type 5, 9, 11	VCC_INTF = 1.8 V	1.17		3.6	
		I/O type 12, 13	VCC_FLSH = 1.8 V	1.17		3.6	
		I/O type 5, 9, 11	VCC_INTF = 2.5 V	1.7		3.6	
		I/O type 12, 13	VCC_FLSH = 2.5 V	1.7		3.6	
		I/O type 5, 9, 11	VCC_INTF = 3.3 V	2.0		3.6	
I/O type 12, 13	VCC_FLSH = 3.3 V	2.0		3.6			
V <sub>IL</sub>	Low-level input threshold voltage	I <sup>2</sup> C buffer (I/O type 7)		-0.5		0.3 × VCC_INTF	V
		I/O type 1, 2, 3, 6, 8 except pins noted in (2)	VCC18 = 1.8 V	-0.3		0.63	
		I/O type 1, 6 for pins noted in (2)	VCC18 = 1.8 V	-0.3		0.5	
		I/O type 5, 9, 11	VCC_INTF = 1.8 V	-0.3		0.63	
		I/O type 12, 13	VCC_FLSH = 1.8 V	-0.3		0.63	
		I/O type 5, 9, 11	VCC_INTF = 2.5 V	-0.3		0.7	
		I/O type 12, 13	VCC_FLSH = 2.5 V	-0.3		0.7	
		I/O type 5, 9, 11	VCC_INTF = 3.3 V	-0.3		0.8	
I/O type 12, 13	VCC_FLSH = 3.3 V	-0.3		0.8			
V <sub>OH</sub>	High-level output voltage	I/O type 1, 2, 3, 6, 8	VCC18 = 1.8 V	1.35			V
		I/O type 5, 9, 11	VCC_INTF = 1.8 V	1.35			
		I/O type 12, 13	VCC_FLSH = 1.8 V	1.35			
		I/O type 5, 9, 11	VCC_INTF = 2.5 V	1.7			
		I/O type 12, 13	VCC_FLSH = 2.5 V	1.7			
		I/O type 5, 9, 11	VCC_INTF = 3.3 V	2.4			
I/O type 12, 13	VCC_FLSH = 3.3 V	2.4					
V <sub>OL</sub>	Low-level output voltage	I <sup>2</sup> C buffer (I/O type 7)	VCC_INTF > 2 V			0.4	V
		I <sup>2</sup> C buffer (I/O type 7)	VCC_INTF < 2 V			0.2 × VCC_INTF	
		I/O type 1, 2, 3, 6, 8	VCC18 = 1.8 V			0.45	
		I/O Type 5, 9, 11	VCC_INTF = 1.8 V			0.45	
		I/O Type 12, 13	VCC_FLSH = 1.8 V			0.45	
		I/O Type 5, 9, 11	VCC_INTF = 2.5 V			0.7	
		I/O Type 12, 13	VCC_FLSH = 2.5 V			0.7	
		I/O Type 5, 9, 11	VCC_INTF = 3.3 V			0.4	
I/O Type 12, 13	VCC_FLSH = 3.3 V			0.4			

## 6.6 Pin Electrical Characteristics (continued)

over operating free-air temperature range (unless otherwise noted)

PARAMETER <sup>(3)</sup>		TEST CONDITIONS <sup>(4)</sup>	MIN	TYP	MAX	UNIT	
I <sub>OH</sub>	High-level output current <sup>(5)</sup>	I/O type 2, 4	VCC18 = 1.8 V	2		mA	
		I/O type 5	VCC_INTF = 1.8 V	2			
		I/O type 1	VCC18 = 1.8 V	3.5			
		I/O type 9	VCC_INTF = 1.8 V	3.5			
		I/O type 13	VCC_FLSH = 1.8 V	3.5			
		I/O type 3	VCC18 = 1.8 V	10.6			
		I/O type 5	VCC_INTF = 2.5 V	5.4			
		I/O type 9, 13	VCC_INTF = 2.5V	10.8			
		I/O type 13	VCC_FLSH = 2.5 V	10.8			
		I/O type 5	VCC_INTF = 3.3 V	7.8			
		I/O type 9	VCC_INTF = 3.3 V	15			
		I/O type 13	VCC_FLSH = 3.3 V	15			
I <sub>OL</sub>	Low-level output current <sup>(6)</sup>	I <sup>2</sup> C buffer (I/O type 7)		3		mA	
		I/O type 2, 4	VCC18 = 1.8 V	2.3			
		I/O type 5	VCC_INTF = 1.8 V	2.3			
		I/O type 1	VCC18 = 1.8 V	4.6			
		I/O type 9	VCC_INTF = 1.8 V	4.6			
		I/O type 13	VCC_FLSH = 1.8 V	4.6			
		I/O type 3	VCC18 = 1.8 V	13.9			
		I/O type 5	VCC_INTF = 2.5 V	5.2			
		I/O type 9	VCC_INTF = 2.5 V	10.4			
		I/O type 13	VCC_FLSH = 2.5 V	10.4			
		I/O type 5	VCC_INTF = 3.3 V	4.4			
		I/O type 9	VCC_INTF = 3.3 V	8.9			
		I/O type 13	VCC_FLSH = 3.3 V	8.9			
I <sub>oz</sub>	High-impedance leakage current	I <sup>2</sup> C buffer (I/O type 7)	V <sub>I<sup>2</sup>C buffer</sub> < 0.1 × VCC_INTF or V <sub>I<sup>2</sup>C buffer</sub> > 0.9 × VCC_INTF	-10		10	μA
		I/O type 1, 2, 3, 6, 8,	VCC18 = 1.8 V	-10		10	
		I/O Type 5, 9, 11	VCC_INTF = 1.8 V	-10		10	
		I/O Type 12, 13	VCC_FLSH = 1.8 V	-10		10	
		I/O type 5, 9, 11	VCC_INTF = 2.5 V	-10		10	
		I/O Type 12, 13	VCC_FLSH = 2.5 V	-10		10	
		I/O Type 5, 9, 11	VCC_INTF = 3.3 V	-10		10	
I/O type 12, 13	VCC_FLSH = 3.3 V	-10		10			

## 6.6 Pin Electrical Characteristics (continued)

over operating free-air temperature range (unless otherwise noted)

PARAMETER <sup>(3)</sup>		TEST CONDITIONS <sup>(4)</sup>	MIN	TYP	MAX	UNIT
C <sub>i</sub>	I <sup>2</sup> C buffer (I/O type 7)				5	pF
	I/O type 1, 2, 3, 6, 8	VCC18 = 1.8 V	2.6		3.5	
	I/O Type 5, 9, 11	VCC_INTF = 1.8 V	2.6		3.5	
	I/O Type 12, 13	VCC_FLSH = 1.8 V	2.6		3.5	
	I/O type 5, 9, 11	VCC_INTF = 2.5 V	2.6		3.5	
	I/O type 12, 13	VCC_FLSH = 2.5 V	2.6		3.5	
	I/O type 5, 9, 11	VCC_INTF = 3.3 V	2.6		3.5	
	I/O type 12, 13	VCC_FLSH = 3.3 V	2.6		3.5	
	sub-LVDS – DMD high speed (I/O type 4)	VCC18 = 1.8 V			3	

- (1) I/O is high voltage tolerant; that is, if VCC\_INTF = 1.8 V, the input is 3.3-V tolerant, and if VCC\_INTF = 3.3 V, the input is 5-V tolerant.
- (2) Controller pins CMP\_OUT, PARKZ, RESETZ, and GPIO\_00 through GPIO\_19 have slightly varied V<sub>IH</sub> and V<sub>IL</sub> range from other 1.8-V I/O.
- (3) The I/O type refers to the type defined in [Table 5-10](#).
- (4) Test conditions that define a value for VCC18, VCC\_INTF, or VCC\_FLSH show the nominal voltage that the specified I/O's supply reference is set to.
- (5) At a high level output signal, the given I/O will be able to output at least the minimum current specified.
- (6) At a low level output signal, the given I/O will be able to sink at least the minimum current specified.

## 6.7 Internal Pullup and Pulldown Electrical Characteristics

over operating free-air temperature (unless otherwise noted) <sup>(2)</sup>

INTERNAL PULLUP AND PULLDOWN RESISTOR CHARACTERISTICS		TEST CONDITIONS <sup>(1)</sup>	MIN	MAX	UNIT
Weak pullup resistance		VCCIO = 3.3 V	29	63	kΩ
		VCCIO = 2.5 V	38	90	kΩ
		VCCIO = 1.8 V	56	148	kΩ
Weak pulldown resistance		VCCIO = 3.3 V	30	72	kΩ
		VCCIO = 2.5 V	36	101	kΩ
		VCCIO = 1.8 V	52	167	kΩ

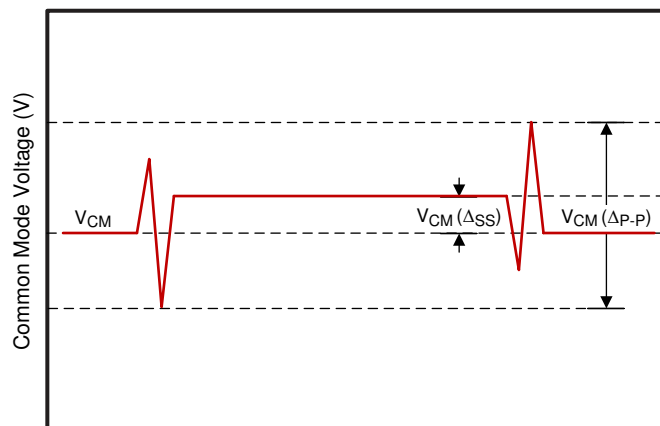
- (1) The resistance is dependent on VCCIO, the pin's supply reference (see a given pins supply reference in [Table 5-10](#)).
- (2) An external 8-kΩ pullup or pulldown (if needed) would work for any voltage condition to correctly pull enough to override any associated internal pullups or pulldowns.

## 6.8 DMD Sub-LVDS Interface Electrical Characteristics

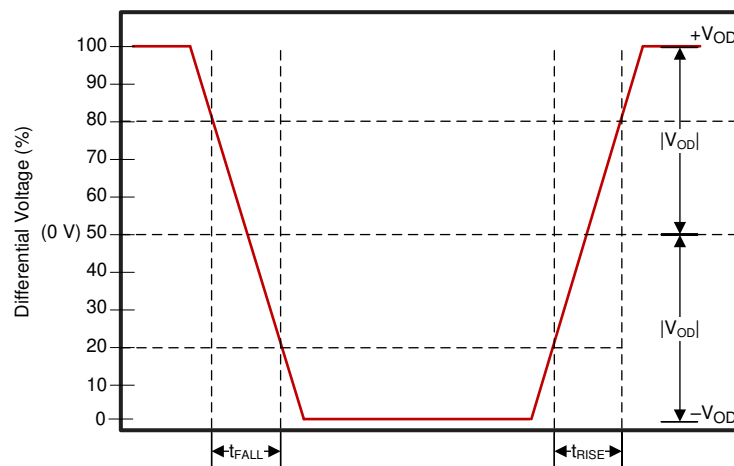
over operating free-air temperature range (unless otherwise noted)

PARAMETER	TEST CONDITIONS	MIN	TYP	MAX	UNIT
$V_{CM}$	Common mode voltage	0.8	0.9	1.0	V
$V_{CM} (\Delta_{pp})^{(1)}$	$V_{CM}$ change peak-to-peak (during switching)			75	mV
$V_{CM} (\Delta_{ss})^{(1)}$	$V_{CM}$ change steady state	-10		10	mV
$ V_{OD} ^{(2)}$	Differential output voltage magnitude	170	250	350	mV
$V_{OD} (\Delta)$	$V_{OD}$ change (between logic states)	-10		10	mV
$V_{OH}$	Single-ended output voltage high	0.825	1.025	1.175	V
$V_{OL}$	Single-ended output voltage low	0.625	0.775	0.975	V
$T_{Xterm}$	Internal differential termination	80	100	120	$\Omega$
$T_{Xload}$	100- $\Omega$ differential PCB trace (50- $\Omega$ transmission lines)	0.5		6	inches

- (1) See [Figure 6-1](#)
- (2)  $V_{OD}$  is the differential voltage measured across a 100- $\Omega$  termination resistance connected directly between the transmitter differential pins.  $V_{OD} = V_P - V_N$ , where P and N are the differential output pins.  $|V_{OD}|$  is the magnitude of the peak-to-peak voltage swing across the P and N output pins (see [Figure 6-2](#)).  $V_{CM}$  cancels out between signals when measured differentially, thus the reason  $V_{OD}$  swings relative to zero.



**Figure 6-1. Common Mode Voltage**



$V_{CM}$  is removed when the signals are viewed differentially

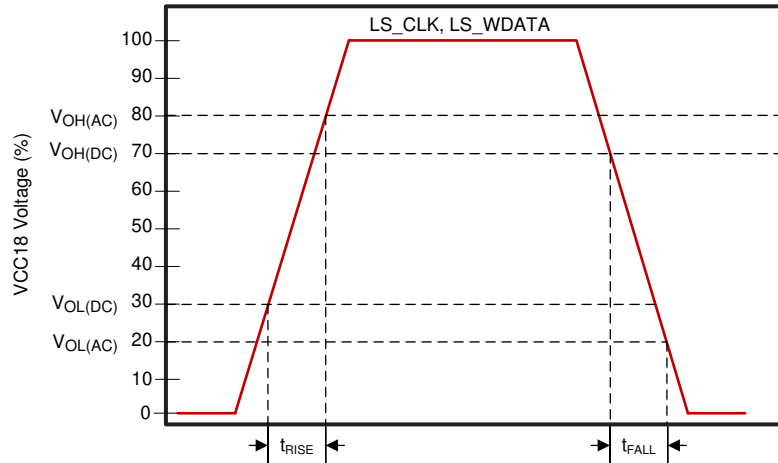
**Figure 6-2. Differential Output Signal**

## 6.9 DMD Low-Speed Interface Electrical Characteristics

over operating free-air temperature range (unless otherwise noted)

PARAMETER <sup>(3)</sup>	TEST CONDITIONS	MIN	TYP	MAX	UNIT	
$V_{OH(DC)}$	DC output high voltage for DMD_LS_WDATA and DMD_LS_CLK	$0.7 \times V_{CC18}$			V	
$V_{OL(DC)}$	DC output low voltage for DMD_LS_WDATA and DMD_LS_CLK			$0.3 \times V_{CC18}$	V	
$V_{OH(AC)}$ <sup>(1)</sup>	AC output high voltage for DMD_LS_WDATA and DMD_LS_CLK	$0.8 \times V_{CC18}$	$V_{CC18} + 0.5$		V	
$V_{OL(AC)}$ <sup>(2)</sup>	AC output low voltage for DMD_LS_WDATA and DMD_LS_CLK	-0.5	$0.2 \times V_{CC18}$		V	
Slew rate	DMD_LS_WDATA and DMD_LS_CLK	$V_{OL(DC)}$ to $V_{OH(AC)}$ for rising edge and $V_{OH(DC)}$ to $V_{OL(AC)}$ for falling edge		1.0	3.0	V/ns
	DMD_DEN_ARSTZ	$V_{OL(AC)}$ to $V_{OH(AC)}$ for rising edge		0.25		
	DMD_LS_RDATA			0.5		

- $V_{OH(AC)}$  maximum applies to overshoot. When the DMD\_LS\_WDATA and DMD\_LS\_CLK lines include a proper 43-Ω series termination resistor, the DMD operates within the LPSDR input AC specifications.
- $V_{OL(AC)}$  minimum applies to undershoot. When the DMD\_LS\_WDATA and DMD\_LS\_CLK lines include a proper 43-Ω series termination resistor, the DMD operates within the LPSDR input AC specifications.
- See [Figure 6-3](#) for DMD\_LS\_CLK, and DMD\_LS\_WDATA rise and fall times. See [Figure 6-4](#) for DMD\_DEN\_ARSTZ rise and fall times.



**Figure 6-3. LS\_CLK and LS\_WDATA Slew Rate**

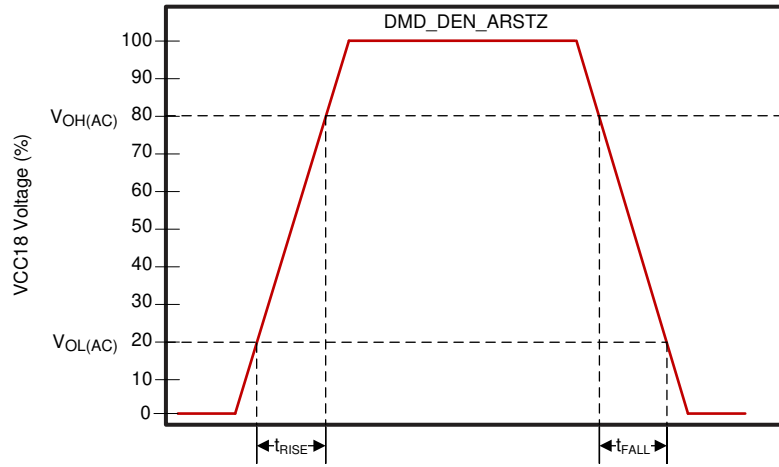
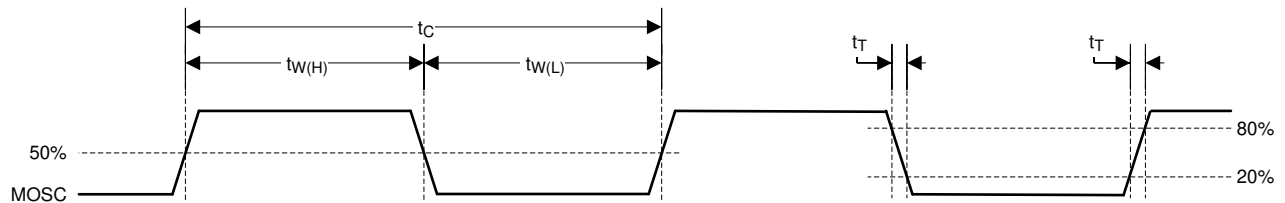


Figure 6-4. DMD\_DEN\_ARSTZ Slew Rate

## 6.10 System Oscillator Timing Requirements

			MIN	NOM	MAX	UNIT
$f_{clk}$	Clock frequency, MOSC (master oscillator clock) <sup>(1)</sup>		23.998	24.000	24.002	MHz
$t_c$	Cycle time, MOSC (clock period) <sup>(1)</sup>	See <a href="#">Figure 6-5</a>	41.663	41.667	41.670	ns
$t_{w(H)}$	Pulse duration as percent of $t_c$ <sup>(2)</sup> , MOSC, high	50% to 50% reference points (signal)	40%	50%		
$t_{w(L)}$	Pulse duration as percent of $t_c$ <sup>(2)</sup> , MOSC, low	50% to 50% reference points (signal)	40%	50%		
$t_t$	Transition time <sup>(2)</sup> , MOSC	20% to 80% reference points (rising signal) 80% to 20% reference points (falling signal)			10	ns
$t_{jp}$	Long-term, peak-to-peak, period jitter <sup>(2)</sup> , MOSC (that is the deviation in period from ideal period due solely to high frequency jitter)				2%	

- (1) The frequency accuracy for MOSC is  $\pm 200$  PPM. (This includes impact to accuracy due to aging, temperature, and trim sensitivity.) The MOSC input does not support spread spectrum clock spreading.
- (2) Applies only when driven by an external digital oscillator.



**Figure 6-5. System Oscillators**

## 6.11 Power Supply and Reset Timing Requirements

			MIN	MAX	UNIT
$t_{w(L)}$	Pulse duration, active low, RESETZ	50% to 50% reference points (signal)	1.25		$\mu\text{s}$
$t_r$	Rise time, RESETZ <sup>(1)</sup>	20% to 80% reference points (signal)		0.5	$\mu\text{s}$
$t_f$	Fall time, RESETZ <sup>(1)</sup>	80% to 20% reference points (signal)		0.5	$\mu\text{s}$
$t_{\text{rise}}$	Rise time, VDD (during VDD ramp up at turn-on)	0.3 V to 1.045 V (VDD)		1	ms

(1) For more information on RESETZ, see [Section 5](#).

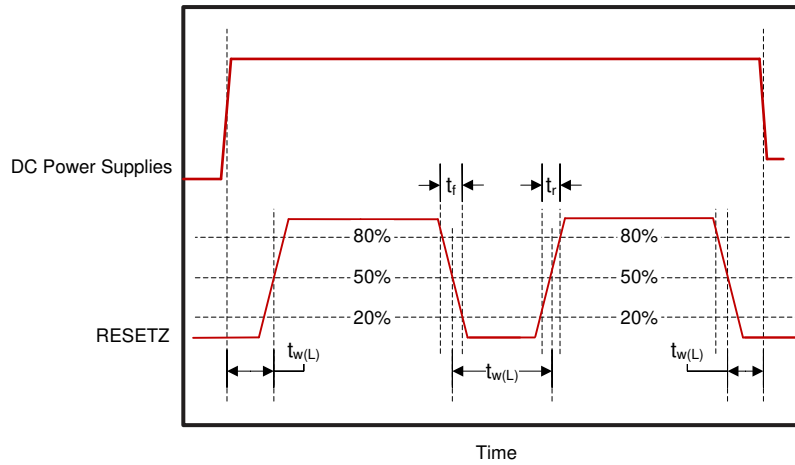


Figure 6-6. Power-Up and Power-Down RESETZ Timing



## 6.12 Parallel Interface Frame Timing Requirements

			MIN	MAX	UNIT
$t_{p\_vsw}$	Pulse duration – default VSYNC_WE high	50% reference points	1		lines
$t_{p\_vbp}$	Vertical back porch (VBP) – time from the active edge of VSYNC_WE to the active edge of HSYNC_CS for the first active line <sup>(1)</sup>	50% reference points	2		lines
$t_{p\_vfp}$	Vertical front porch (VFP) – time from the active edge of the HSYNC_CS following the last active line in a frame to the active edge of VSYNC_WE <sup>(1)</sup>	50% reference points	1		lines
$t_{p\_tvb}$	Total vertical blanking – the sum of VBP and VFP ( $t_{p\_vbp} + t_{p\_vfp}$ )	50% reference points	See <sup>(1)</sup>		lines
$t_{p\_hsw}$	Pulse duration – default HSYNC_CS high	50% reference points	4	128	PCLKs
$t_{p\_hbp}$	Horizontal back porch (HBP) – time from the active edge of HSYNC_CS to the rising edge of DATAEN_CMD	50% reference points	4		PCLKs
$t_{p\_hfp}$	Horizontal front porch (HFP) – time from the falling edge of DATAEN_CMD to the active edge of HSYNC_CS	50% reference points	8		PCLKs

(1) The minimum total vertical blanking is defined by the following equation:  $t_{p\_tvb}(\min) = 6 + [8 \times \text{Max}(1, \text{Source\_ALPF} / \text{DMD\_ALPF})]$  lines where:

- SOURCE\_ALPF = Input source active lines per frame
- DMD\_ALPF = Actual DMD used lines per frame supported

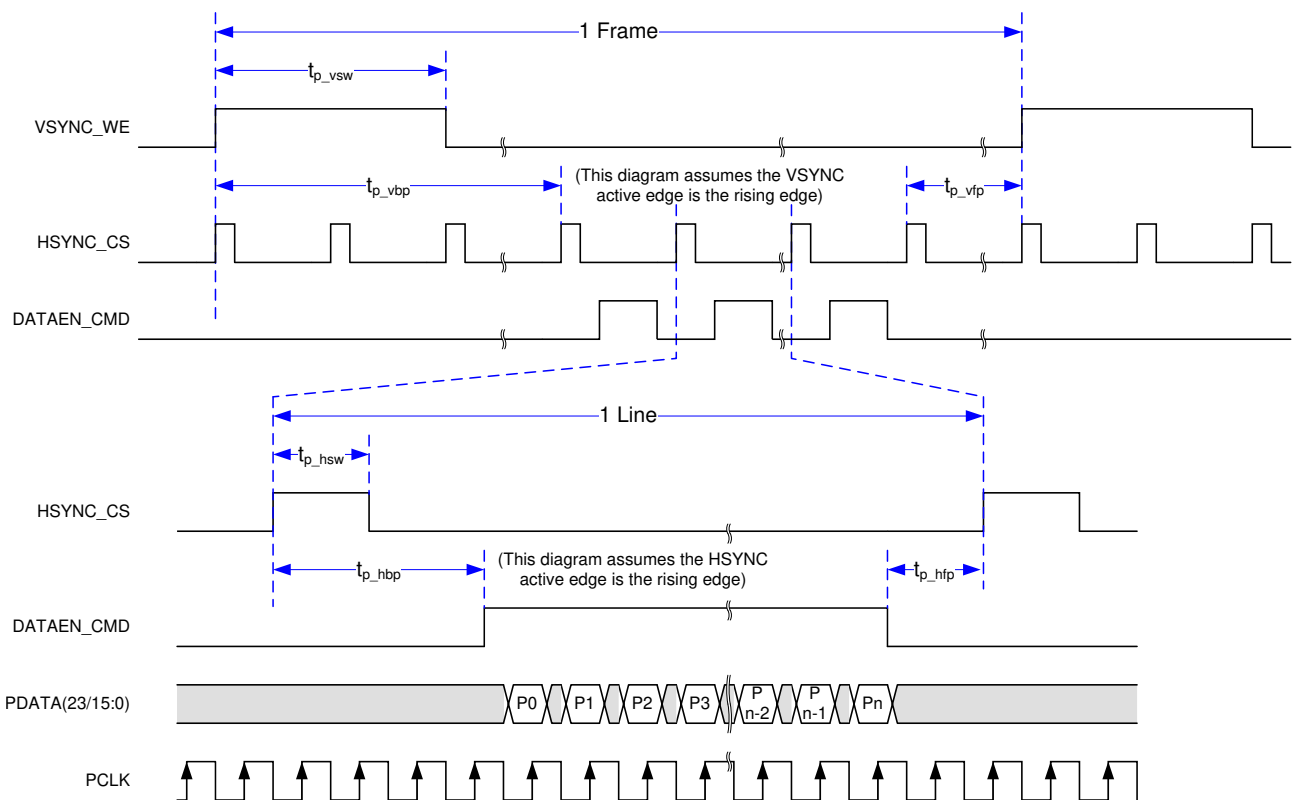
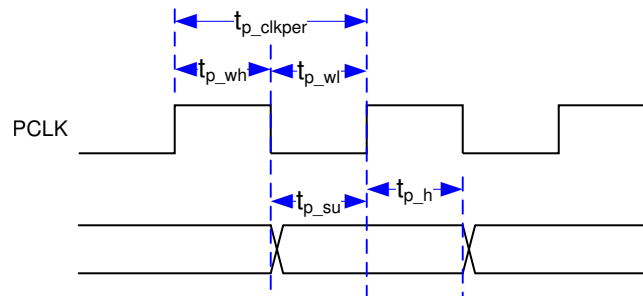


Figure 6-7. Parallel Interface Frame Timing

## 6.13 Parallel Interface General Timing Requirements

			MIN	MAX	UNIT
$f_{\text{clock}}$	PCLK frequency		1.0	155.0	MHz
$t_{\text{p\_clkper}}$	PCLK period	50% reference points	6.45	1000	ns
$t_{\text{p\_clkjit}}$	PCLK jitter	Max $f_{\text{clock}}$	see (1)		
$t_{\text{p\_wh}}$	PCLK pulse duration high	50% reference points	2.43		ns
$t_{\text{p\_wl}}$	PCLK pulse duration low	50% reference points	2.43		ns
$t_{\text{p\_su}}$	Setup time – HSYNC_CS, DATAEN_CMD, PDATA(23:0) valid before the active edge of PCLK	50% reference points	0.9		ns
$t_{\text{p\_h}}$	Hold time – HSYNC_CS, DATAEN_CMD, PDATA(23:0) valid after the active edge of PCLK	50% reference points	0.9		ns
$t_{\text{t}}$	Transition time – all signals	20% to 80% reference points (rising signal) 80% to 20% reference points (falling signal)	0.2	2.0	ns
$t_{\text{setup, 3DR}}$	This is the setup time with respect to VSYNC <sup>(2)</sup>	50% reference points	1.0		ms
$t_{\text{hold, 3DR}}$	This is the hold time with respect VSYNC <sup>(3)</sup>	50% reference points	1.0		ms

- (1) Calculate clock jitter (in ns) using this formula:  $\text{Jitter} = [1 / f_{\text{clock}} - 5.76 \text{ ns}]$ . Setup and hold times must be met even with clock jitter.
- (2) In other words, the 3DR signal must change at least 1.0 ms before VSYNC changes
- (3) In other words, the 3DR signal must not change for at least 1.0 ms after VSYNC changes



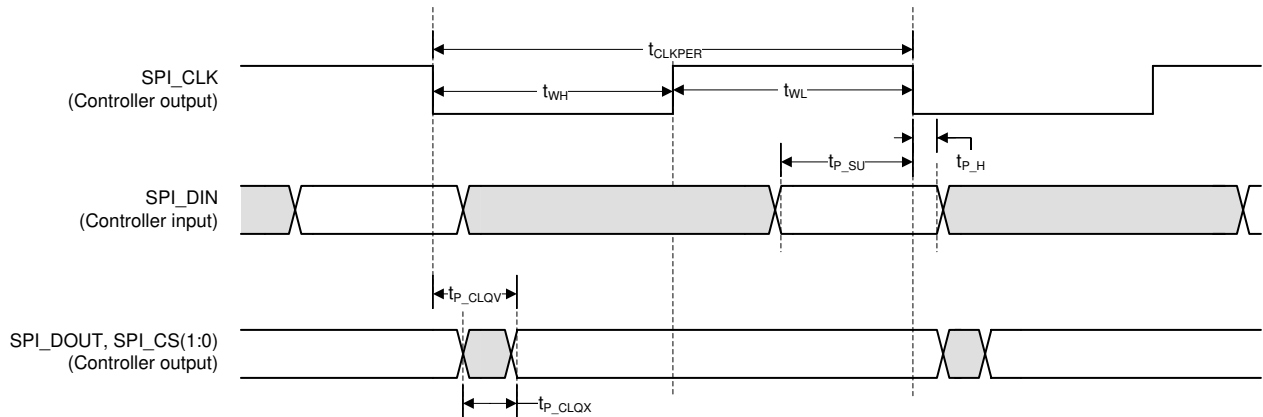
**Figure 6-8. Parallel Interface Pixel Timing**

## 6.14 Flash Interface Timing Requirements

The DLPC34xx flash memory interface consists of a SPI flash serial interface. The DLPC34xx can support 1- to 128-Mb flash memories.<sup>(2) (3) (4)</sup>

			MIN	MAX	UNIT
$f_{\text{clock}}$	SPI_CLK frequency	See <sup>(1)</sup>	1.4	36.0	MHz
$t_{\text{p\_clkper}}$	SPI_CLK period	50% reference points	27.8	704	ns
$t_{\text{p\_wh}}$	SPI_CLK pulse duration high	50% reference points	352		ns
$t_{\text{p\_wl}}$	SPI_CLK pulse duration low	50% reference points	352		ns
$t_{\text{t}}$	Transition time – all signals	20% to 80% reference points (rising signal) 80% to 20% reference points (falling signal)	0.2	3.0	ns
$t_{\text{p\_su}}$	Setup time – SPI_DIN valid before SPI_CLK falling edge	50% reference points	10.0		ns
$t_{\text{p\_h}}$	Hold time – SPI_DIN valid after SPI_CLK falling edge	50% reference points	0.0		ns
$t_{\text{p\_clqv}}$	SPI_CLK clock falling edge to output valid time – SPI_DOUT and SPI_CSZ	50% reference points		1.0	ns
$t_{\text{p\_clqx}}$	SPI_CLK clock falling edge output hold time – SPI_DOUT and SPI_CSZ	50% reference points	-3.0	3.0	ns

- (1) This range include the  $\pm 200$  ppm of the external oscillator (but no jitter).
- (2) Standard SPI protocol is to transmit data on the falling edge of SPI\_CLK and capture data on the rising edge. The DLPC34xx does transmit data on the falling edge, but it also captures data on the falling edge rather than the rising edge. This provides support for SPI devices with long clock-to-Q timing. DLPC34xx hold capture timing has been set to facilitate reliable operation with standard external SPI protocol devices.
- (3) With the above output timing, DLPC34xx provides the external SPI device 8.2-ns input set-up and 8.2-ns input hold, relative to the rising edge of SPI\_CLK.
- (4) For additional requirements of the external flash device view the [Section 7.3.3.1](#) section.



**Figure 6-9. Flash Interface Timing**

## 6.15 Other Timing Requirements

		MIN	MAX	UNIT
$t_{rise, all}^{(1)(2)}$	20% to 80% reference points		10	ns
$t_{fall, all}^{(1)(2)}$	80% to 20% reference points		10	ns
$t_{rise, PARKZ}^{(2)}$	20% to 80% reference points		150	ns
$t_{fall, PARKZ}^{(2)}$	80% to 20% reference points		150	ns
$t_w, GPIO\_08$ (normal park) pulse width <sup>(3)</sup>		200		ms
I <sup>2</sup> C baud rate			100	kHz

- (1) Unless noted elsewhere, the following signal transition times are for all DLPC34xx signals.  
(2) This is the recommended signal transition time to avoid input buffer oscillations.  
(3) When the controller is turned off by setting PROJ\_ON low, PROJ\_ON must not be brought high again for at least 200 ms. View [Section 9.3](#) for additional requirements.

## 6.16 DMD Sub-LVDS Interface Switching Characteristics

over operating free-air temperature range (unless otherwise noted)

PARAMETER		TEST CONDITIONS	MIN	TYP	MAX	UNIT
$t_R^{(1)}$	Differential output rise time				250	ps
$t_F^{(1)}$	Differential output fall time				250	
$t_{switch}$	DMD HS Clock switching rate			1064		Mbps
$f_{clock}$	DMD HS Clock frequency			532		MHz
DCout	DMD HS Clock output duty cycle		45%	50%	55%	

- (1) Rise and fall times are defined for the differential  $V_{OD}$  signal as shown in [Figure 6-2](#).

## 6.17 DMD Parking Switching Characteristics

See [\(2\)](#)

PARAMETER		TEST CONDITIONS	MIN	TYP	MAX	UNIT
$t_{park}$	Normal Park time <sup>(1)</sup>				20	ms
$t_{fast\ park}$	Fast park time <sup>(3)</sup>				32	$\mu$ s

- (1) Normal park time is defined as how long it takes the DLPC34xx controller to complete the parking of the DMD after it receives the normal park request (GPIO\_08 goes low).  
(2) The oscillator and power supplies must remain active for at least the duration of the park time. The power supplies must additionally be held on for a time after parking is completed to satisfy DMD requirements. See [Section 9.2](#) and the appropriate DMD or PMIC datasheet for more information.  
(3) Fast park time is defined as how long it takes the DLPC34xx controller to complete the parking of the DMD after it receives the fast park request (PARKZ goes low).

## 6.18 Chipset Component Usage Specification

The DLPC3439 is a component of a DLP chipset. Reliable function and operation of the DLP chipset requires that it be used with all components (DMD, PMIC, and controller) of the applicable DLP chipset.

**Table 6-1. DLPC3439 Supported DMDs and PMICs**

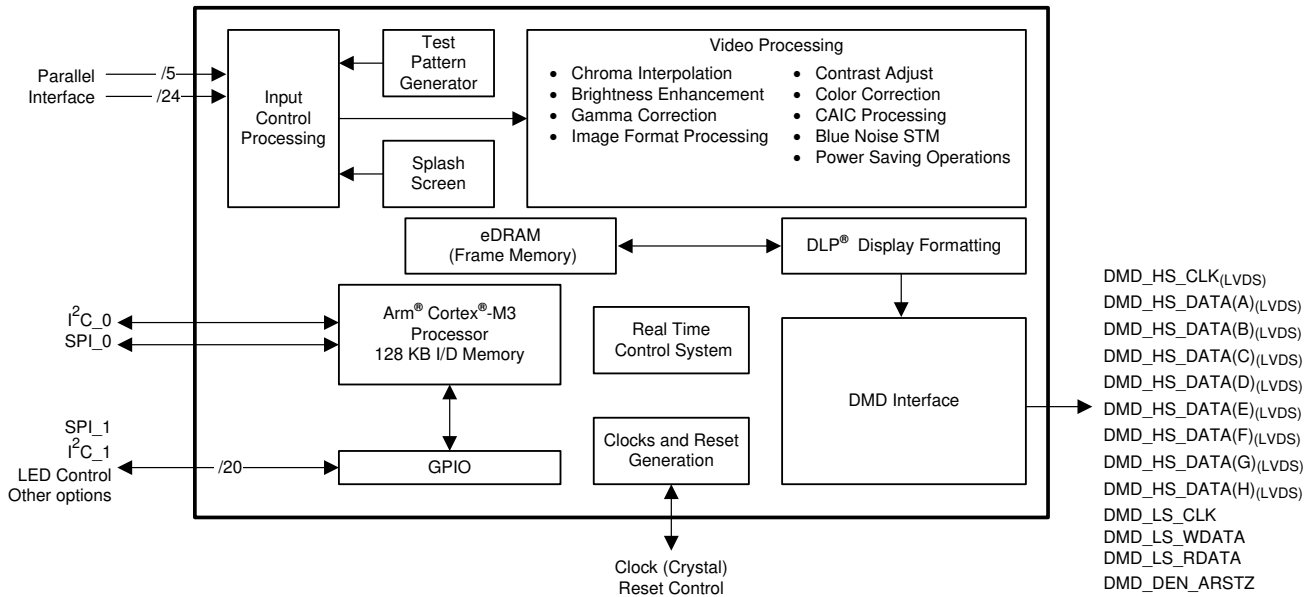
DLPC3439 DLP Chipset (two DLPC3439 controllers required)	
DMD	DLP4710
PMIC	DLPA3000
	DLPA3005

## 7 Detailed Description

### 7.1 Overview

The DLPC3439 is the display controller for the DLP4710 (0.47 1080p) DMD. The DLPC3439 is part of the chipset comprising two DLPC3439 controllers, the DLP4710 (0.47 1080p) DMD, and the DLPA3000 or DLPA3005 PMIC/LED driver. All four components of the chipset must be used in conjunction with each other for reliable operation of the DLP4710 (0.47 1080p) DMD. Each DLPC3439 display controller provides interfaces and data and image processing functions that are optimized for small form factor and power-constrained display applications. Applications include pico projectors, wearable displays, and digital signage. The DLPC3439 is not a front-end processor; therefore, standalone projectors must include a separate front-end chip to interface to the outside world (for example, video decoder, HDMI receiver, triple ADC, or USB I/F chip).

### 7.2 Functional Block Diagram



## 7.3 Feature Description

### 7.3.1 Input Source Requirements

#### 7.3.1.1 Supported Resolution and Frame Rates

**Table 7-1. Supported Input Source Ranges (1) (2) (3)**

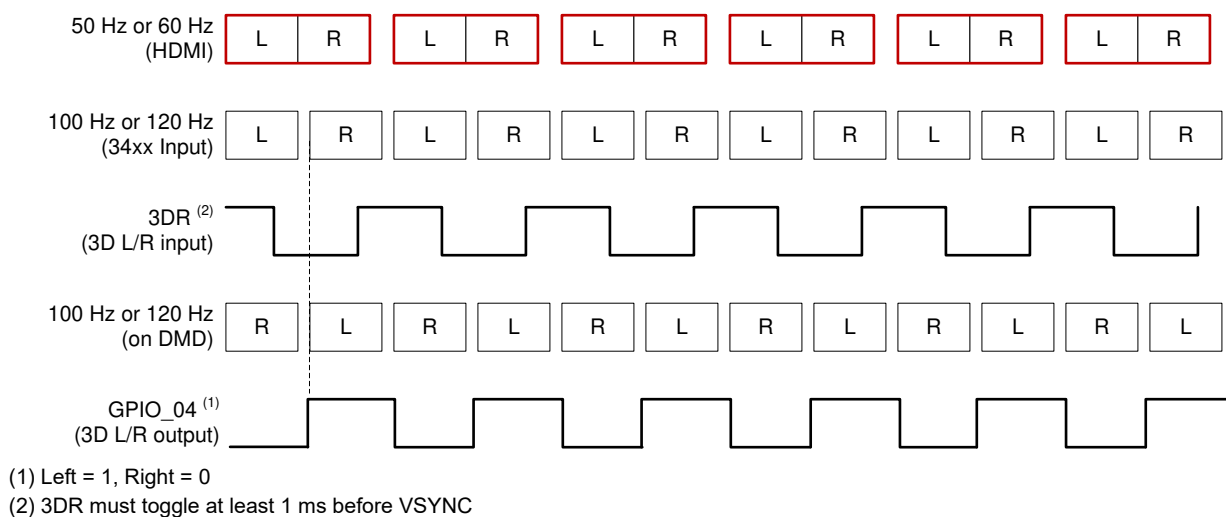
INTERFACE	Bits per Pixel (max) <sup>(4)</sup>	IMAGE TYPE	SOURCE RESOLUTION RANGE(pixels)		FRAME RATE RANGE (Hz)
			HORIZONTAL	VERTICAL	
Parallel	24	2D only	400 to 1920	550 to 1080	47 to 63
	24	2D only	400 to 1280	550 to 720	47 to 123
	24	3D only	400 to 1280	550 to 720	100 ±2 120 ±2

- (1) The application must remain within specifications for all source interface parameters such as maximum clock rate and maximum line rate.
- (2) The maximum DMD size for all rows in the table is 1920 × 1080 pixels.
- (3) To achieve the ranges stated, the firmware must support the source parameters. Review the firmware release notes or contact TI to determine the latest available frame rate and input resolution support for a given firmware image.
- (4) Bits per pixel does not necessarily equal the number of data pins used on the DLPC34xx controller.

#### 7.3.1.2 3D Display

For 3D sources on the video input interface, images must be frame sequential (L, R, L, ...) when input to the DLPC34xx controller. Any processing required to unpack 3D images and to convert them to frame sequential input must be done by external electronics prior to inputting the images to the controller. Each 3D source frame input must contain a single eye frame of data, separated by a VSYNC, where an eye frame contains image data for a single left or right eye. The signal 3DR input to the controller indicates whether the input frame is for the left eye or right eye.

Each DMD frame is displayed at the same rate as the input interface frame rate. [Figure 7-1](#) below shows the typical timing for a 50-Hz or 60-Hz 3D HDMI source frame, the input interface of the DLPC34xx controller, and the DMD. In general, video frames sent over the HDMI interface pack both the left and right content into the same video frame. GPIO\_04 is optionally sent to a transmitter on the system PCB for wirelessly transmitting a synchronization signal to 3D glasses (usually an IR sync signal). The glasses are then in phase with the DMD images displayed. Alternately, the *3D Glasses Operation* section shows how DLP link pulses can be used instead.



**Figure 7-1. 3D Display Left and Right Frame Timing**

### 7.3.1.3 Parallel Interface

The parallel interface complies with standard graphics interface protocol, which includes the signals listed in [Table 7-2](#).

**Table 7-2. Parallel Interface Signals**

SIGNAL	DESCRIPTION
VSYNC_WE	vertical sync
HSYNC_CS	horizontal sync
DATAEN_CMD	data valid
PDATA	24-bit data bus
PCLK	pixel clock
PDM_CVS_TE	parallel data mask (optional)

#### Note

VSYNC\_WE must remain active at all times when using parallel RGB mode. When this signal is no longer active, the display sequencer stops and causes the LEDs to turn off.

The active edge of both sync signals are variable. The *Parallel Interface Frame Timing Requirements* section shows the relationship of these signals.

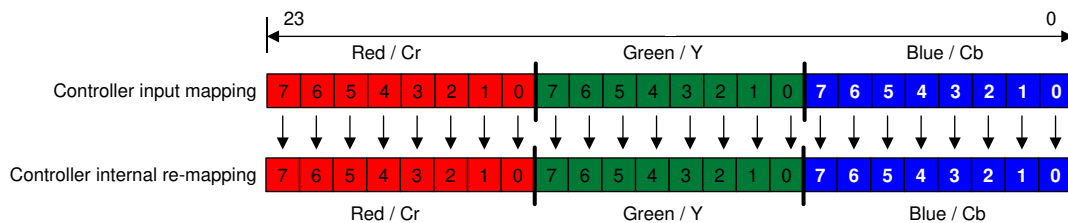
An optional parallel data mask signal (PDM\_CVS\_TE) allows periodic frame updates to be stopped without losing the displayed image. When active, PDM\_CVS\_TE acts as a data mask and does not allow the source image to be propagated to the display. A programmable PDM polarity parameter determines if it is active high or active low. PDM\_CVS\_TE defaults to active high. To disable the data mask function, tie PDM\_CVS\_TE to a logic low signal. PDM\_CVS\_TE must only change during vertical blanking.

The parallel interface supports six data transfer formats. They are as follows:

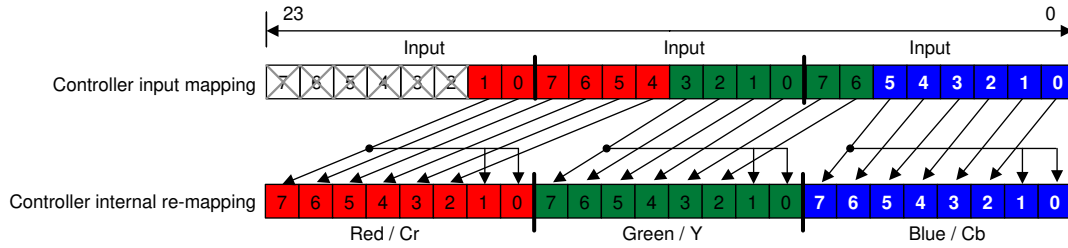
- 24-bit RGB888 or 24-bit YCbCr888 on a 24 data wire interface
- 18-bit RGB666 or 18-bit YCbCr666 on an 18 data wire interface
- 16-bit RGB565 or 16-bit YCbCr565 on a 16 data wire interface
- 16-bit YCbCr 4:2:2 (standard sampling assumed to be Y0Cb0, Y1Cr0, Y2Cb2, Y3Cr2, Y4Cb4, Y5Cr4, ...)
- 8-bit RGB888 or 8-bit YCbCr888 serial (1 color per clock input; 3 clocks per displayed pixel) on an 8 data wire interface
- 8-bit YCbCr 4:2:2 serial (1 color per clock input; 2 clocks per displayed pixel) on an 8 data wire interface

[Section 7.3.1.3.1](#) shows the required PDATA(23:0) bus mapping for these six data transfer formats.

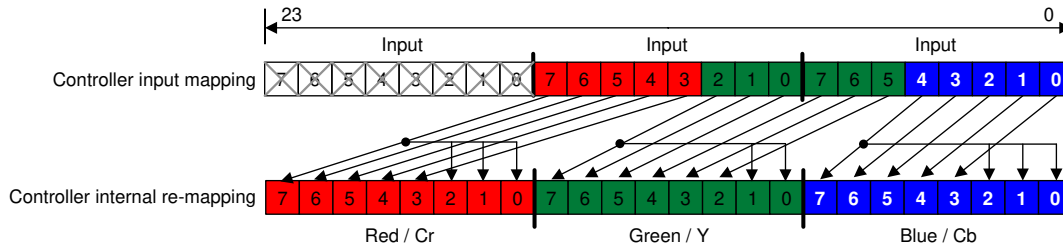
#### 7.3.1.3.1 PDATA Bus – Parallel Interface Bit Mapping Modes



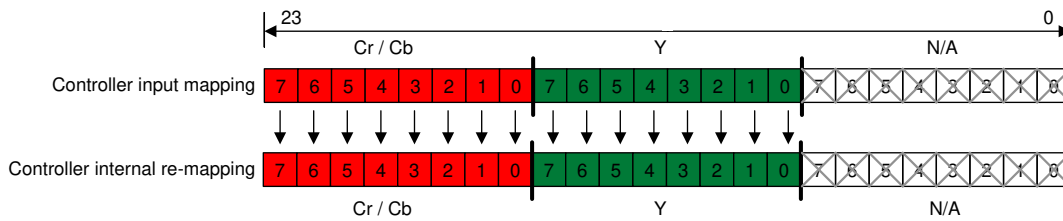
**Figure 7-2. RGB-888 and YCbCr-888 I/O Mapping**



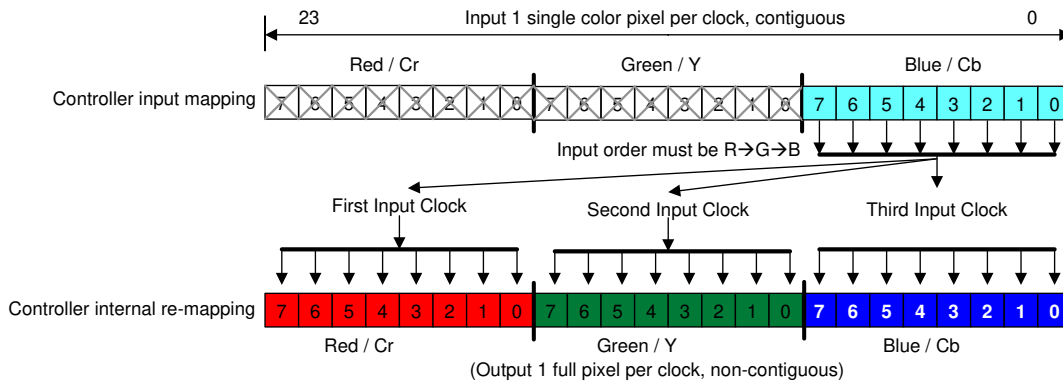
**Figure 7-3. RGB-666 and YCbCr-666 I/O Mapping**



**Figure 7-4. RGB-565 and YCbCr-565 I/O Mapping**

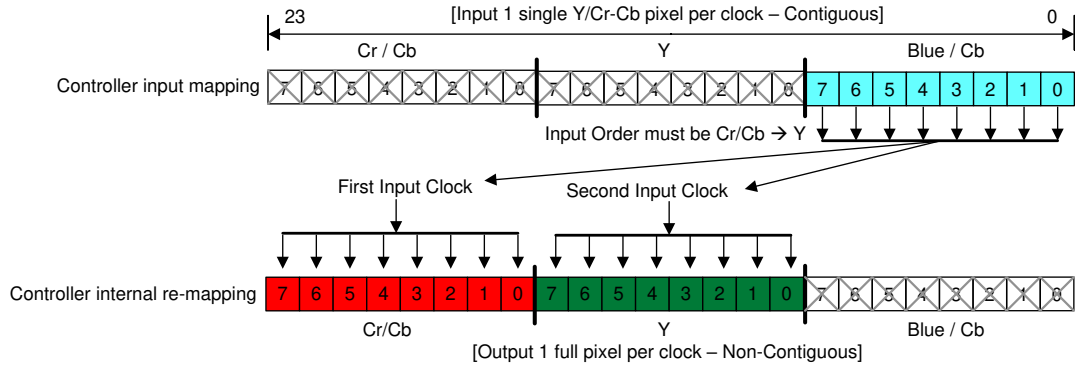


**Figure 7-5. 16-Bit YCbCr-880 I/O Mapping**



**Figure 7-6. 8-Bit RGB-888 or YCbCr-888 I/O Mapping**

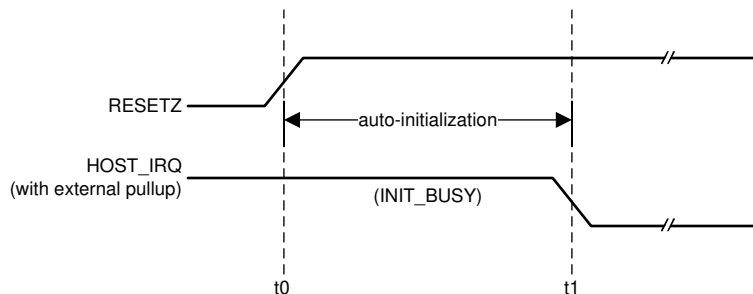




**Figure 7-7. 8-Bit Serial YCbCr-422 I/O Mapping**

### 7.3.2 Device Startup

- The HOST\_IRQ signal is provided to indicate when the system has completed auto-initialization.
- While reset is applied, HOST\_IRQ is tri-stated (an external pullup resistor pulls the line high).
- HOST\_IRQ remains tri-stated (pulled high externally) until the boot process completes. While the signal is pulled high, this indicates that the controller is performing boot-up and auto-initialization.
- As soon as possible after the controller boots-up, the controller drives HOST\_IRQ to a logic high state to indicate that the controller is continuing to perform auto-initialization (no real state changes occur on the external signal).
- The software sets HOST\_IRQ to a logic low state at the completion of the auto-initialization process. At the falling edge of the signal, the initialization is complete.
- The DLPC34xx controller is ready to receive commands through I<sup>2</sup>C or accept video over the video interface only after auto-initialization is complete.
- The controller initialization typically completes (HOST\_IRQ goes low) within 500 ms of RESETZ being asserted. However, this time may vary depending on the software version and the contents of the user configurable auto initialization file.



t0: rising edge of RESETZ; auto-initialization begins

t1: falling edge of HOST\_IRQ; auto-initialization is complete

**Figure 7-8. HOST\_IRQ Timing**

### 7.3.3 SPI Flash

#### 7.3.3.1 SPI Flash Interface

The DLPC34xx controller requires an external SPI serial flash memory device to store the firmware. Follow the below guidelines and requirements in addition to the requirements listed in the *Flash Interface Timing Requirements* section.

The controller supports a maximum flash size of 128 Mb (16 MB). See the DLPC34xx Validated SPI Flash Device Options table for example compatible flash options. The minimum required flash size depends on the size of the utilized firmware. The firmware size depends upon a variety of factors including the number of sequences, lookup tables, and splash images.

The DLPC34xx controller uses a single SPI interface that complies to industry standard SPI flash protocol. The device will begin accessing the flash at a nominal 1.42-MHz frequency before running at a nominal 30-MHz rate. The flash device must support these rates.

The controller has two independent SPI chip select (CS) control lines. Ensure that the chip select pin of the flash device is connects to SPI0\_CSZ0 as the controller boot routine is executes from the device connected to chip select zero. The boot routine uploads program code from flash memory to program memory then transfers control to an auto-initialization routine within program memory.

The DLPC34xx is designed to support any flash device that is compatible with the modes of operation, features, and performance as defined in the Additional DLPC34xx SPI Flash Requirements table below [Table 7-3](#), [Table 7-4](#), and [Table 7-5](#).

**Table 7-3. Additional DLPC34xx SPI Flash Requirements**

FEATURE	DLPC34xx REQUIREMENT
SPI interface width	Single
SPI polarity and phase settings	SPI mode 0
Fast READ addressing	Auto-incrementing
Programming mode	Page mode
Page size	256 B
Sector size	4-KB sector
Block size	Any
Block protection bits	0 = Disabled
Status register bit(0)	Write in progress (WIP), also called flash busy
Status register bit(1)	Write enable latch (WEN)
Status register bits(6:2)	A value of 0 disables programming protection
Status register bit(7)	Status register write protect (SRWP)
Status register bits(15:8) (that is expansion status byte)	Because the DLPC34xx controller supports only single-byte status register R/W command execution, it may not be compatible with flash devices that contain an expansion status byte. However, as long as the expansion status byte is considered optional in the byte 3 position and any write protection control in this expansion status byte defaults to unprotected, then the flash device is likely compatible with the DLPC34xx.

The DLPC34xx controller is intended to support flash devices with program protection defaults of either enabled or disabled. The controller assumes the default is enabled and proceeds to disable any program protection as part of the boot process.

The DLPC34xx issues these commands during the boot process:

- A write enable (WREN) instruction to request write enable, followed by
- A read status register (RDSR) instruction (repeated as needed) to poll the write enable latch (WEL) bit
- After the write enable latch (WEL) bit is set, a write status register (WRSR) instruction that writes 0 to all 8 bits (this disables all programming protection)

Prior to each program or erase instruction, the DLPC34xx controller issues similar commands:

- A write enable (WREN) instruction to request write enable, followed by
- A read status register (RDSR) instruction (repeated as needed) to poll the write enable latch (WEL) bit
- After the write enable latch (WEL) bit is set, the program or erase instruction

Note that the flash device automatically clears the write enable status after each program and erase instruction.

[Table 7-4](#) and [Table 7-5](#) below list the specific instruction OpCode and timing compatibility requirements. The DLPC34xx controller does not adapt protocol or clock rate based on the flash type connected.

**Table 7-4. SPI Flash Instruction OpCode and Access Profile Compatibility Requirements**

SPI FLASH COMMAND	BYTE 1 (OPCODE)	BYTE 2	BYTE 3	BYTE 4	BYTE 5	BYTE 6
Fast READ (1 output)	0x0B	ADDRS(0)	ADDRS(1)	ADDRS(2)	dummy	DATA(0) <sup>(1)</sup>
Read status	0x05	N/A	N/A	STATUS(0)		
Write status	0x01	STATUS(0)	See <sup>(2)</sup>			
Write enable	0x06					
Page program	0x02	ADDRS(0)	ADDRS(1)	ADDRS(2)	DATA(0) <sup>(1)</sup>	
Sector erase (4 KB)	0x20	ADDRS(0)	ADDRS(1)	ADDRS(2)		
Chip erase	0xC7					

- (1) Shows the first data byte only. Data continues.  
(2) Access to a second (expansion) write status byte not supported by the DLPC34xx controller.

Table 7-5 below and the *Flash Interface Timing Requirements* section list the specific timing compatibility requirements for a DLPC34xx compatible flash device.

**Table 7-5. SPI Flash Key Timing Parameter Compatibility Requirements**

SPI FLASH TIMING PARAMETER <sup>(1) (2)</sup>	SYMBOL	ALTERNATE SYMBOL	MIN	MAX	UNIT
Access frequency (all commands)	FR	$f_C$	$\leq 1.4$	$\geq 30.1$	MHz
Chip select high time (also called chip select deselect time)	$t_{SHSL}$	$t_{CSH}$	$\leq 200$		ns
Output hold time	$t_{CLQX}$	$t_{HO}$	$\geq 0$		ns
Clock low to output valid time	$t_{CLQV}$	$t_V$		$\leq 11$	ns
Data in set-up time	$t_{DVCH}$	$t_{DSU}$	$\leq 5$		ns
Data in hold time	$t_{CHDX}$	$t_{DH}$	$\leq 5$		ns

- (1) The timing values apply to the specification of the peripheral flash device, not the DLPC34xx controller. For example, the flash device minimum access frequency (FR) must be 1.4 MHz or less and the maximum access frequency must be 30.1 MHz or greater.  
(2) The DLPC34xx does not drive the HOLD or WP (active low write protect) pins on the flash device, and thus these pins must be tied to a logic high on the PCB through an external pullup.

In order for the DLPC34xx controller to support 1.8-V, 2.5-V, or 3.3-V serial flash devices, the VCC\_FLASH pin must be supplied with the corresponding voltage. The DLPC34xx Validated SPI Flash Device Options table contains a list of validated 1.8-V, 2.5-V, or 3.3-V compatible SPI serial flash devices supported by the DLPC34xx controller.

**Table 7-6. DLPC34xx Validated SPI Flash Device Options <sup>(1) (2) (3)</sup>**

DENSITY (Mb)	VENDOR	PART NUMBER	PACKAGE SIZE
<b>1.8-V COMPATIBLE DEVICES</b>			
4 Mb	Winbond	W25Q40BWUXIG	2 × 3 mm USON
4 Mb	Macronix	MX25U4033EBAI-12G	1.43 × 1.94 mm WLCSP
8 Mb	Macronix	MX25U8033EBAI-12G	1.68 × 1.99 mm WLCSP
<b>2.5- OR 3.3-V COMPATIBLE DEVICES</b>			
16 Mb	Winbond	W25Q16CLZPIG	5 × 6 mm WSON

- (1) The flash supply voltage must equal VCC\_FLASH supply voltage on the DLPC34xx controller. Make sure to order the device that supports the correct supply voltage as multiple voltage options are often available.  
(2) Numonyx (Micron) serial flash devices typically do not support the 4 KB sector size compatibility requirement for the DLPC34xx controller.  
(3) The flash devices in this table have been formally validated by TI. Other flash options may be compatible with the DLPC34xx controller, but they have not been formally validated by TI.

### 7.3.3.2 SPI Flash Programming

The SPI pins of the flash can directly be driven for flash programming while the DLPC34xx controller I/Os are tri-stated. SPI0\_CLK, SPI0\_DOUT, and SPI0\_CSZ0 I/O can be tri-stated by holding RESETZ in a logic low state

while power is applied to the controller. The logic state of the SPI0\_CSZ1 pin is not affected by this action. Alternatively, the DLPC34xx controller can program the SPI flash itself when commanded via I<sup>2</sup>C if a valid firmware image has already been loaded and the controller is operational.

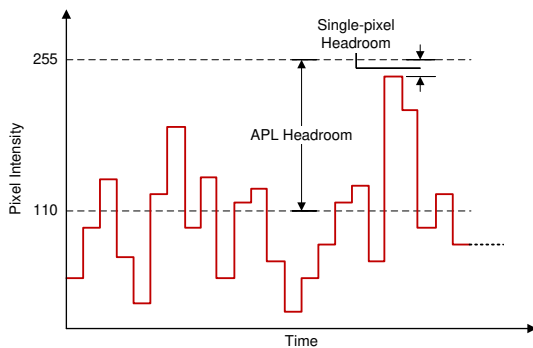
### 7.3.4 I<sup>2</sup>C Interface

Both of the DLPC34xx I<sup>2</sup>C interface ports support a 100-kHz baud rate. Because I<sup>2</sup>C interface transactions operate at the speed of the slowest device on the bus, there is no requirement to match the speed of all devices in the system.

### 7.3.5 Content Adaptive Illumination Control (CAIC)

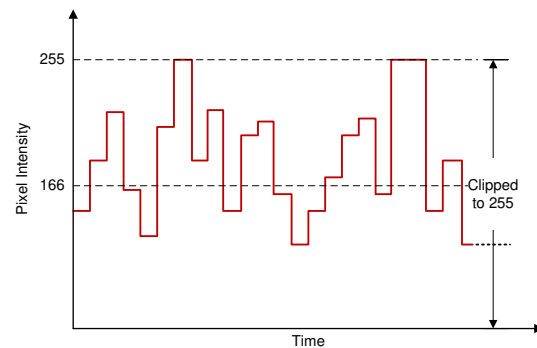
Content Adaptive Illumination control (CAIC) is part of the IntelliBright<sup>®</sup> suite of advanced image processing algorithms that adaptively enhances brightness and reduces power. In common real-world image content most pixels in the images are well below full scale for the R (red), G (green), and B (blue) digital channels input to the DLPC34xx. As a result of this, the average picture level (APL) for the overall image is also well below full scale, and the dynamic range for the collective set of pixel values is not fully used. CAIC takes advantage of the headroom between the source image APL and the top of the available dynamic range of the display system.

CAIC evaluates images on a frame-by-frame basis and derives three unique digital gains, one for each of the R, G, and B color channel. During image processing, CAIC applies each gain to all pixels in the associated color channel. The calculated gain is applied to all pixels in that channel so that the pixels as a group collectively shift upward and as close to full scale as possible. To prevent any image quality degradation, the gains are set at the point where just a few pixels in each color channel are clipped. The [Source Pixels for a Color Channel](#) and [Pixels for a Color Channel After CAIC Processing](#) figures below show an example of the application of CAIC for one color channel.



(1) APL = 110

**Figure 7-9. Source Pixels for a Color Channel**

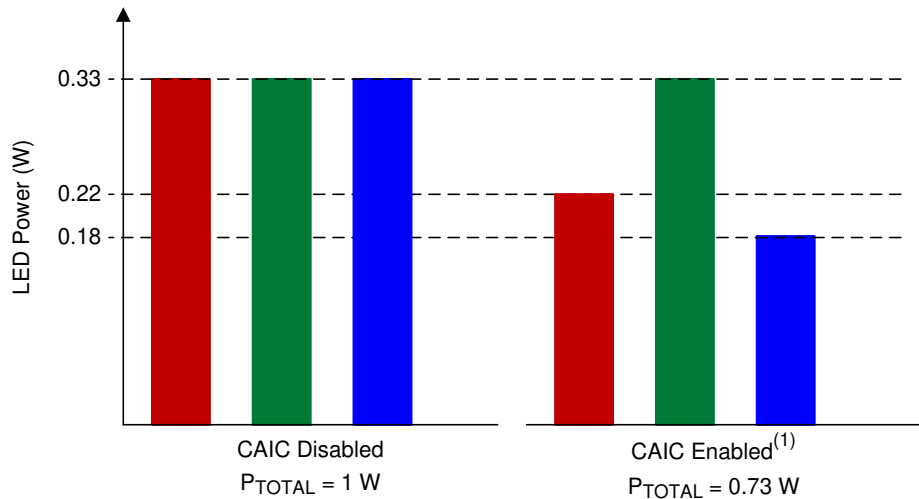


(1) APL = 166

(2) Channel gain =  $166/110 = 1.51$

**Figure 7-10. Pixels for a Color Channel After CAIC Processing**

Above, [Figure 7-10](#) shows the gain that is applied to a color processing channel inside the DLPC34xx. Additionally, CAIC adjusts the power for the R, G, and B LED by commanding different LED currents. For each color channel of an individual frame, CAIC intelligently determines the optimal combination of digital gain and LED power. The user configurable CAIC settings heavily influence the amount of digital gain that is applied to a color channel and the LED power for that color.



(1) With CAIC enabled, if red and blue LEDs require less than nominal power for a given input image, the red and blue LED power will reduce.

**Figure 7-11. CAIC Power Reduction Mode (for Constant Brightness)**

As CAIC applies a digital gain to each color channel and adjusts the power to each LED, CAIC ensures the resulting color balance in the final image matches the target color balance for the projector system. Thus, the effective displayed white point of images is held constant by CAIC from frame to frame.

CAIC can be used to increase the overall image brightness while holding the total power for all LEDs constant, or CAIC can be used to hold the overall image brightness constant while decreasing LED power. In summary, CAIC has two primary modes of operation:

- Power reduction mode holds overall image brightness constant while reducing LED power
- Enhanced brightness mode holds overall LED power constant while enhancing image brightness

In power reduction mode, since the R, G, and B channels can be gained up by CAIC inside the DLPC34xx, the LED power can be reduced for any color channel until the brightness of the color on the screen is unchanged. Thus, CAIC can achieve an overall LED power reduction while maintaining the same overall image brightness as if CAIC was not used. [Figure 7-11](#) shows an example of LED power reduction by CAIC for an image where the red and blue LEDs can consume less power.

In enhanced brightness mode the R, G, and B channels can be gained up by CAIC with LED power generally being held constant. This results in an enhanced brightness with no power savings.

While there are two primary modes of operation described, the DLPC34xx actually operates within the extremes of pure power reduction mode and enhanced brightness mode. The user can configure which operating mode the DLPC34xx will more closely follow by adjusting the CAIC gain setting as described in the software programmer's guide.

In addition to the above functionality, CAIC also can be used as a tool with which FOFO (full-on full-off) contrast on a projection system can be improved. While operating in power reduction mode, the DLPC34xx reduces LED power as the intensity of the image content for each color channel decreases. This will result in the LEDs operating at nominal settings with full-on content (a white screen) and reducing power output until the dimmest possible content (a black screen) is reached. In this latter case, the LEDs will be operating at minimum power output capacity and thus producing the minimum possible amount of off-state light. This optimization provided by CAIC will thereby improve FOFO contrast ratio. The given contrast ratio will further increase as nominal LED current (full-on state) is increased.

### 7.3.6 Local Area Brightness Boost (LABB)

Local area brightness boost (LABB), part of the IntelliBright™ suite of advanced image processing algorithms, adaptively gains up regions of an image that are dim relative to the average picture level. The controller applies

significant gain to some regions of the image, and applies little or no gain to other regions. The LABB algorithm evaluates images frame-by-frame and calculates the local area gains to be used for each image. Since many images have a net overall boost in gain, even if the controller applies no gain to some parts of the image, the controller boosts the overall perceived brightness of the image.

Figure 7-12 below shows a split screen example of the impact of the LABB algorithm for an image that includes dark areas.



**Figure 7-12. LABB enabled (left side) and LABB disabled (right side)**

The LABB algorithm operates most effectively when ambient light conditions are used to help determine the decision about the strength of gains utilized. For this reason, it may be useful to include an ambient light sensor in the system design that is used to measure the display screen's reflected ambient light. This sensor can assist in dynamically controlling the LABB strength. Set the LABB gain higher for bright rooms to help overcome washed out images. Set the LABB gain lower in dark rooms to prevent overdriven pixel intensities in images.

### 7.3.7 3D Glasses Operation

When using 3D glasses (with 3D video input and appropriate software support), the controller outputs sync information to align the left eye and right eye shuttering in the glasses with the displayed DMD image frames. 3D glasses typically use either Infrared (IR) transmission or DLP Link™ technology to achieve this synchronization.

One glasses type uses an IR transmitter on the system PCB to send an IR sync signal to an IR receiver in the glasses. In this case DLPC34xx controller output signal GPIO\_04 can be used to cause the IR transmitter to send an IR sync signal to the glasses. The Figure 7-13 figure shows the timing sequence for the GPIO\_04 signal.

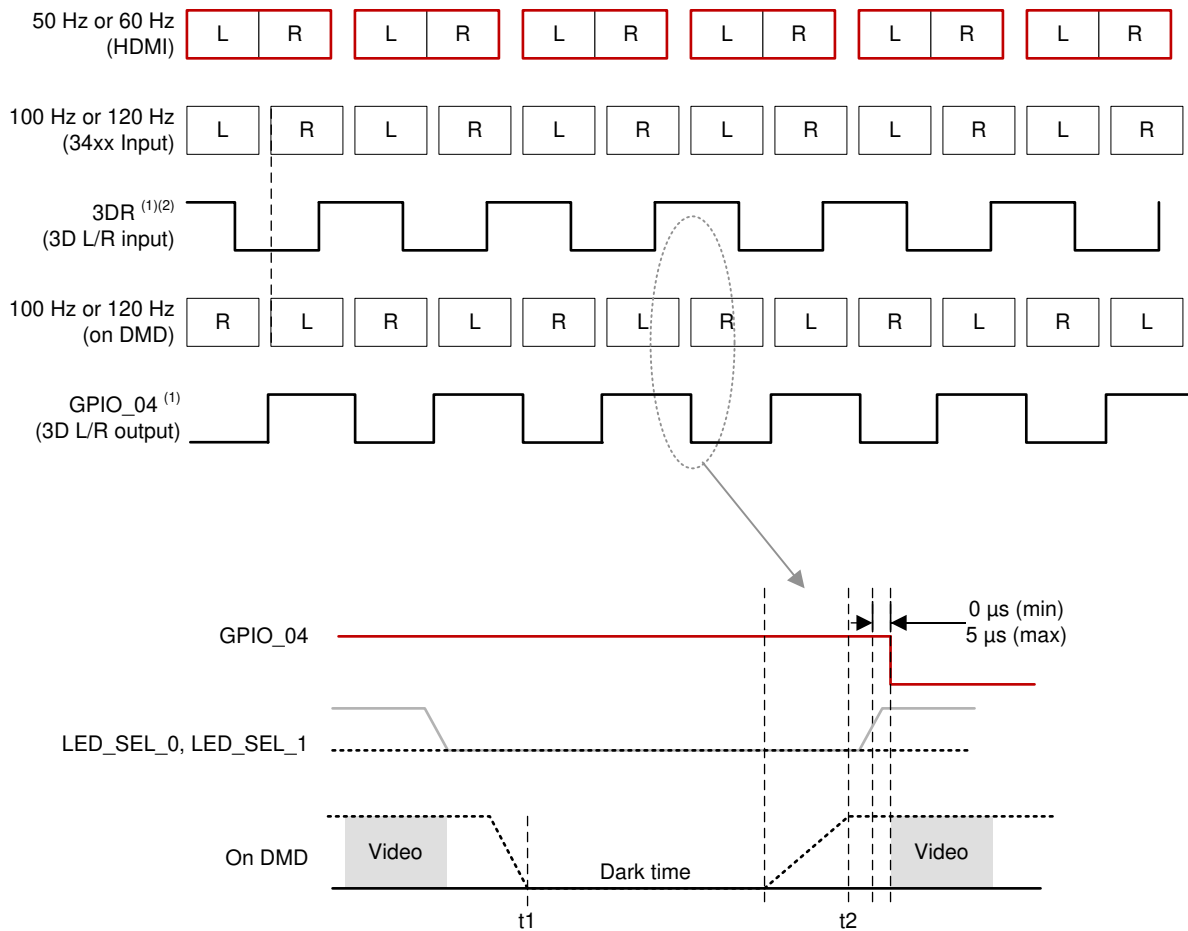
The second type of glasses relies on sync information that is encoded into the light being output from the projection lens. This approach uses the DLP Link feature for 3D video. Many 3D glasses from different suppliers have been built using this method. The advantage of using the DLP Link feature is that it takes advantage of existing projector hardware to transmit the sync information to the glasses. This method may give an advantage in cost, size and power savings in the projector.



**DLPC3439**

DLPS057E – NOVEMBER 2014 – REVISED FEBRUARY 2021

When using DLP Link technology, one light pulse per DMD frame is output from the projection lens while the glasses have both shutters closed. To achieve this, the DLPC34xx tells the DLPxxxx when to turn on the illumination source (typically LEDs or lasers) so that an encoded light pulse is output once per DMD frame. Because the shutters in the glasses are both off when the pulse is sent, the projector illumination source is also off except when the light is sent to create the pulse. The pulses may use any color; however, due to the transmission property of the eye-glass LCD shutter lenses and the sensitivity of the white-light sensor used on the eye-glasses, it is highly recommended that blue is not used for pulses. Red pulses are the recommended color to use. The Figure 7-13 figure below shows 3D timing information. Figure 7-14 and Table 7-7 show the timing for the light pulses when using the DLP Link feature.



(1) Left = 1, Right = 0

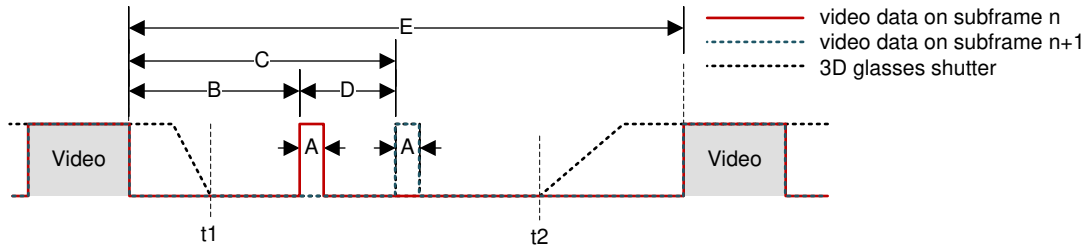
(2) 3DR must toggle 1 ms before VSYNC

t1: both shutters turned off

t2: next shutter turned on

**Figure 7-13. 3D Display Left and Right Frame and Signal Timing**





The time offset of DLP Link pulses at the end of a subframe alternates between B and B+D where D is the delta offset.

Figure 7-14. 3D DLP Link Pulse Timing

Table 7-7. 3D DLP Link Timing

HDMI Source Frame Rate (Hz) <sup>(1)</sup>	DLPC34xx Input Frame Rate (Hz)	A (µs)	B (µs)	C (µs)	D (µs)	E (µs)
49.0	98	20 - 32 (31.8 nominal)	> 500	> 622	128 - 163 (161.6 nominal)	> 2000
50.0	100	20 - 32 (31.2 nominal)	> 500	> 658	128 - 163 (158.4 nominal)	> 2000
51.0	102	20 - 32 (30.6 nominal)	> 500	> 655	128 - 163 (155.3 nominal)	> 2000
59.0	118	20 - 32 (26.4 nominal)	> 500	> 634	128 - 163 (134.2 nominal)	> 2000
60.0	120	20 - 32 (26.0 nominal)	> 500	> 632	128 - 163 (132.0 nominal)	> 2000
61.0	122	20 - 32 (25.6 nominal)	> 500	> 630	128 - 163 (129.8 nominal)	> 2000

(1) Timing parameter C is always the sum of B+D.

### 7.3.8 Test Point Support

The DLPC34xx test point output port, TSTPT\_(7:0), provides selected system calibration and controller debug support. These test points are inputs when reset is applied. These test points are outputs when reset is released. The controller samples the signal state upon the release of system reset and then uses the captured value to configure the test mode until the next time reset is applied. Because each test point includes an internal pulldown resistor, external pullups must be used to modify the default test configuration.

The default configuration (b000) corresponds to the TSTPT\_(2:0) outputs remaining tri-stated to reduce switching activity during normal operation. For maximum flexibility, a jumper to external pullup resistors is recommended for TSTPT\_(2:0). The pullup resistors on TSTPT\_(2:0) can be used to configure the controller for a specific mode or option. TI does not recommend adding pullup resistors to TSTPT\_(7:3) due to potentially adverse effects on normal operation. For normal use TSTPT\_(7:3) should be left unconnected. The test points are sampled only during a 0-to-1 transition on the RESETZ input, so changing the configuration after reset is released does not have any effect until the next time reset asserts and releases. Table 7-8 describes the test mode selections for one programmable scenario defined by TSTPT\_(2:0).

Table 7-8. Test Mode Selection Scenario Defined by TSTPT\_(2:0)

TSTPT OUTPUT VALUE <sup>(1)</sup>	NO SWITCHING ACTIVITY	CLOCK DEBUG OUTPUT
	TSTPT_(2:0) = 0b000	TSTPT_(2:0) = 0b010
TSTPT_0	HI-Z	60 MHz
TSTPT_1	HI-Z	30 MHz
TSTPT_2	HI-Z	0.7 to 22.5 MHz
TSTPT_3	HI-Z	HIGH
TSTPT_4	HI-Z	LOW
TSTPT_5	HI-Z	HIGH

**Table 7-8. Test Mode Selection Scenario Defined by TSTPT\_(2:0) (continued)**

TSTPT OUTPUT VALUE <sup>(1)</sup>	NO SWITCHING ACTIVITY	CLOCK DEBUG OUTPUT
	TSTPT_(2:0) = 0b000	TSTPT_(2:0) = 0b010
TSTPT_6	HI-Z	HIGH
TSTPT_7	HI-Z	7.5 MHz

(1) These are default output selections. Software can reprogram the selection at any time.

### 7.3.9 DMD Interface

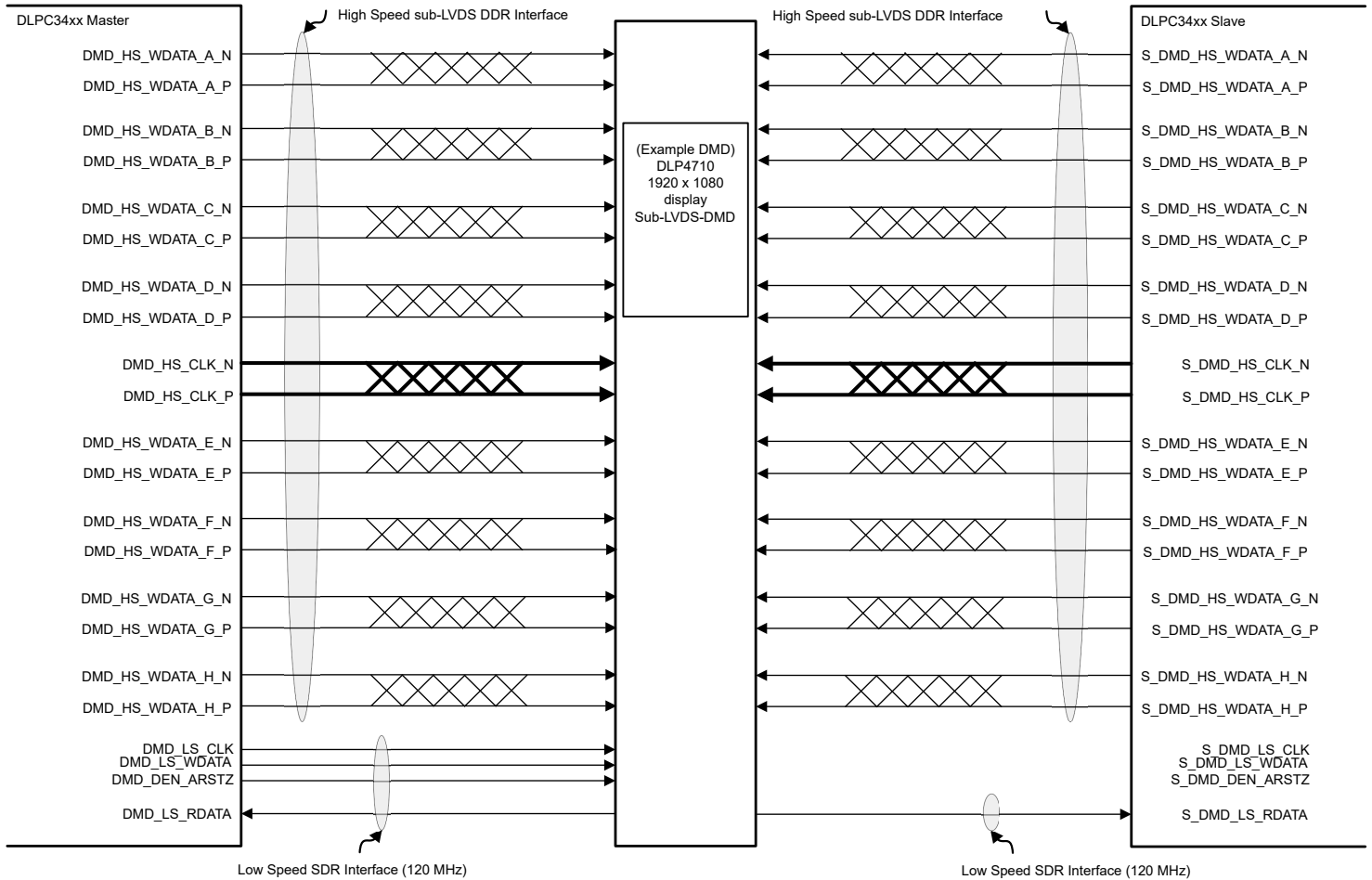
The DLPC34xx controller DMD interface consists of one high-speed (HS), 1.8-V sub-LVDS, output-only interface and one low speed (LS), 1.8-V LVCMOS SDR interface with a typical fixed clock speed of 120 MHz.

#### 7.3.9.1 Sub-LVDS (HS) Interface

The DLPC3439 controller to DMD interface consists of a HS 1.8-V sub-LVDS output only interface with a maximum clock speed of 532-MHz DDR and a LS SDR (1.8-V LVCMOS) interface with a fixed clock speed of 120 MHz. [Table 7-9](#) shows the two options available for the DLP4710 DMD.

**Table 7-9. DLPC3439 (Master and Slave) to DLP4710 (.47 1080p) DMD 8-Lane DMD Pin Mapping**

DLPC3439 controller 8 LANE DMD ROUTING OPTION #1		
MASTER DLPC3439 PINS	SLAVE DLPC3439 PINS	DMD PINS
HS_WDATA_D_P HS_WDATA_D_N	HS_WDATA_E_P HS_WDATA_E_N	Input DATA_p_0 Input DATA_n_0
HS_WDATA_C_P HS_WDATA_C_N	HS_WDATA_F_P HS_WDATA_F_N	Input DATA_p_1 Input DATA_n_1
HS_WDATA_B_P HS_WDATA_B_N	HS_WDATA_G_P HS_WDATA_G_N	Input DATA_p_2 Input DATA_n_2
HS_WDATA_A_P HS_WDATA_A_N	HS_WDATA_H_P HS_WDATA_H_N	Input DATA_p_3 Input DATA_n_3
HS_WDATA_H_P HS_WDATA_H_N	HS_WDATA_A_P HS_WDATA_A_N	Input DATA_p_4 Input DATA_n_4
HS_WDATA_G_P HS_WDATA_G_N	HS_WDATA_B_P HS_WDATA_B_N	Input DATA_p_5 Input DATA_n_5
HS_WDATA_F_P HS_WDATA_F_N	HS_WDATA_C_P HS_WDATA_C_N	Input DATA_p_6 Input DATA_n_6
HS_WDATA_E_P HS_WDATA_E_N	HS_WDATA_D_P HS_WDATA_D_N	Input DATA_p_7 Input DATA_n_7
DLPC3439 controller 8 LANE DMD ROUTING OPTION #2		
MASTER DLPC3439 PINS	SLAVE DLPC3439 PINS	DMD PINS
HS_WDATA_E_P HS_WDATA_E_N	HS_WDATA_D_P HS_WDATA_D_N	Input DATA_p_0 Input DATA_n_0
HS_WDATA_F_P HS_WDATA_F_N	HS_WDATA_C_P HS_WDATA_C_N	Input DATA_p_1 Input DATA_n_1
HS_WDATA_G_P HS_WDATA_G_N	HS_WDATA_B_P HS_WDATA_B_N	Input DATA_p_2 Input DATA_n_2
HS_WDATA_H_P HS_WDATA_H_N	HS_WDATA_A_P HS_WDATA_A_N	Input DATA_p_3 Input DATA_n_3
HS_WDATA_A_P HS_WDATA_A_N	HS_WDATA_H_P HS_WDATA_H_N	Input DATA_p_4 Input DATA_n_4
HS_WDATA_B_P HS_WDATA_B_N	HS_WDATA_G_P HS_WDATA_G_N	Input DATA_p_5 Input DATA_n_5
HS_WDATA_C_P HS_WDATA_C_N	HS_WDATA_F_P HS_WDATA_F_N	Input DATA_p_6 Input DATA_n_6
HS_WDATA_D_P HS_WDATA_D_N	HS_WDATA_E_P HS_WDATA_E_N	Input DATA_p_7 Input DATA_n_7



**Figure 7-15. DLP4710 (.47 1080p) DMD Interface**

The sub-LVDS high-speed interface waveform quality and timing on the DLPC34xx controller depends on the total length of the interconnect system, the spacing between traces, the characteristic impedance, etch losses, and how well matched the lengths are across the interface. Thus, ensuring positive timing margin requires attention to many factors.

In an attempt to minimize the signal integrity analysis that would otherwise be required, the *DMD Control and Sub-LVDS Signals* layout section is provided as a reference of an interconnect system that satisfy both waveform quality and timing requirements (accounting for both PCB routing mismatch and PCB signal integrity). Variation from these recommendations may also work, but should be confirmed with PCB signal integrity analysis or lab measurements.

## 7.4 Device Functional Modes

The DLPC34xx controller has two functional modes (ON and OFF) controlled by a single pin, PROJ\_ON (GPIO\_08).

- When the PROJ\_ON pin is set high, the controller powers up and can be programmed to send data to the DMD.
- When the PROJ\_ON pin is set low, the controller powers down and consumes minimal power.

## 7.5 Programming

The DLPC34xx controller contains an Arm® Cortex®-M3 processor with additional functional blocks to enable video processing and control. TI provides software as a firmware image. The customer is required to flash this firmware image onto the SPI flash memory. The DLPC34xx controller loads this firmware during startup and regular operation. The controller and its accompanying DLP chipset requires this proprietary software to operate. The available controller functions depend on the firmware version installed. Different firmware is required for different chipset combinations (such as when using different PMIC devices). See *Documentation Support* at the end of this document or contact TI to view or download the latest published software.

Users can modify software behavior through I<sup>2</sup>C interface commands. For a list of commands, view the software user's guide accessible through the *Documentation Support* page.

## 8 Application and Implementation

---

### Note

Information in the following applications sections is not part of the TI component specification, and TI does not warrant its accuracy or completeness. TI's customers are responsible for determining suitability of components for their purposes, as well as validating and testing their design implementation to confirm system functionality.

---

### 8.1 Application Information

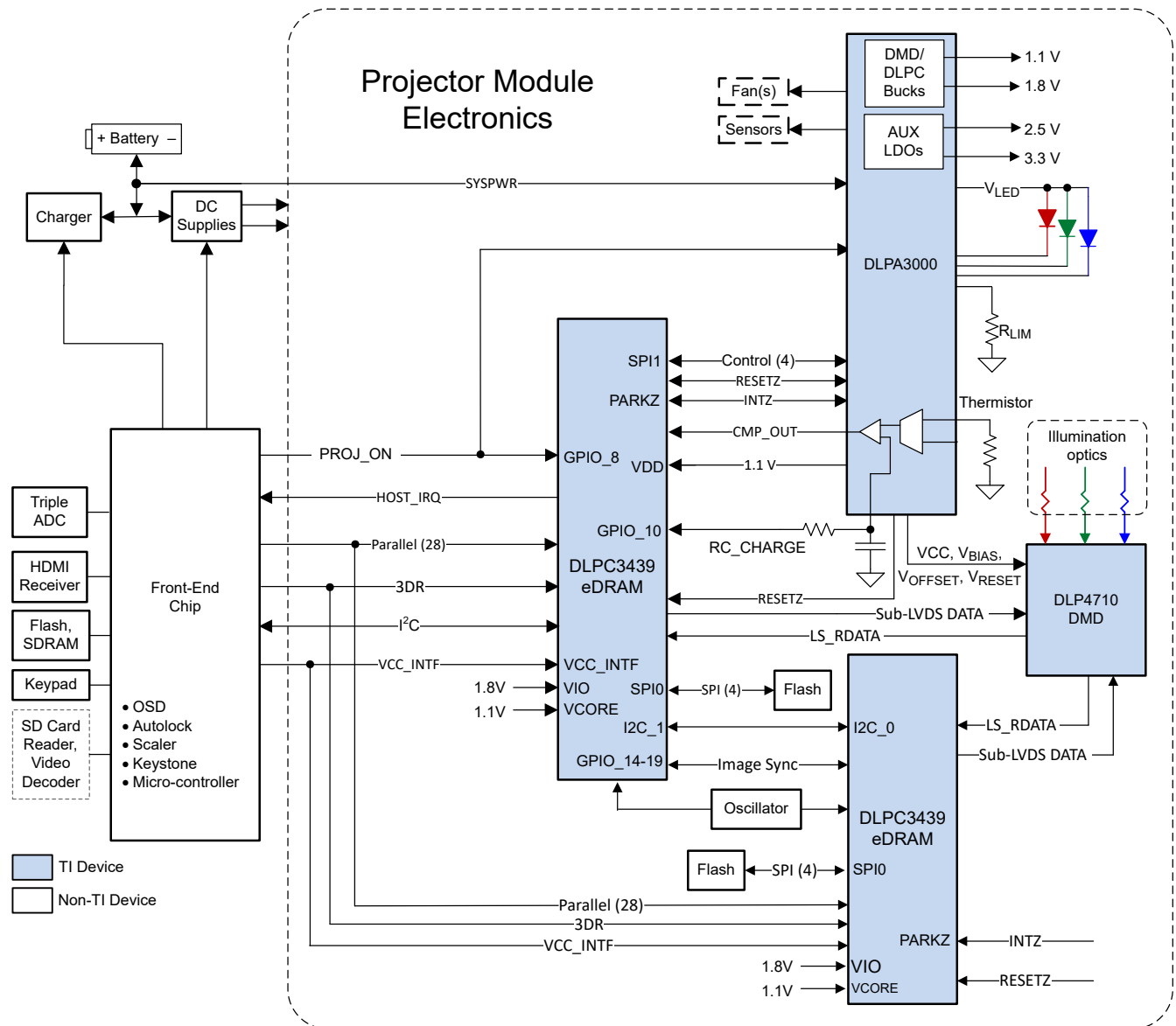
The DLPC34xx controller is used with the DLP4710 DMD to provide a reliable display solution for many data and video display applications. The DMDs are spatial light modulators which reflect incoming light from an illumination source to one of two directions, with the primary direction being into projection or collection optics. The optical architecture of the system and the format of the image digital data coming into the DLPC34xx are what primarily determine the application requirements.

Click these links to find more information about typical applications:

[DLP Signage](#), [Mobile Projector](#), [Mobile Smart TV](#), [Commercial gaming displays](#), [Smart home displays](#), [Pico projectors](#).

### 8.2 Typical Application

A common application using a DLPC3439 controller with a DLP4710 DMD and a DLPA3000/DLPA3005 PMIC/LED driver is creating an accessory Pico projector for a smartphone, tablet, or any other display source. The DLPC3439 in the accessory Pico projector typically receives images from a host processor or a multi media processor.



**Figure 8-1. Typical Application Diagram**

### 8.2.1 Design Requirements

A Pico projector is created by using a DLP chipset comprised of a DLP4710 (.47 1080p) DMD, a 2xDLPC3439 controller and a DLPA3000/DLPA3005 PMIC/LED driver. The DLPC3439 does the digital image processing, the DLPA3000/DLPA3005 provides the needed analog functions for the projector, and the DMD is the display device for producing the projected image.

In addition to the three DLP chips in the chipset, other chips may be needed. At a minimum a flash part is needed to store the software and firmware to control the DLPC3439.

The illumination light that is applied to the DMD is typically from red, green, and blue LEDs. These are often contained in three separate packages, but sometimes more than one color of LED die may be in the same package to reduce the overall size of the pico-projector.

For connecting the DLPC3439 to the host processing for receiving images, parallel interface is used. I<sup>2</sup>C should be connected to the host processor for sending commands to the DLPC3439.

The only power supply needed external to the DLPC3439-based chipset is an AC adapter or battery to provide the SYSPWR DC voltage. The DLPA3000 or DLPA3005 PMIC will create all of the DC supplies needed by the DLPC3439-based chipset as well as those needed by all other electronics in the projector.

The entire pico-projector can be turned on and off by using a single signal called PROJ\_ON. When PROJ\_ON is high, the projector turns on and begins displaying images. When PROJ\_ON is set low, the projector turns off and draws just microamps of current on SYSPWR. When PROJ\_ON is set low, the 1.8-V supply can continue to be left at 1.8 V and used by other non-projector sections of the product. If PROJ\_ON is low, the DLPA3000/DLPA3005 will not draw current on the 1.8-V supply.

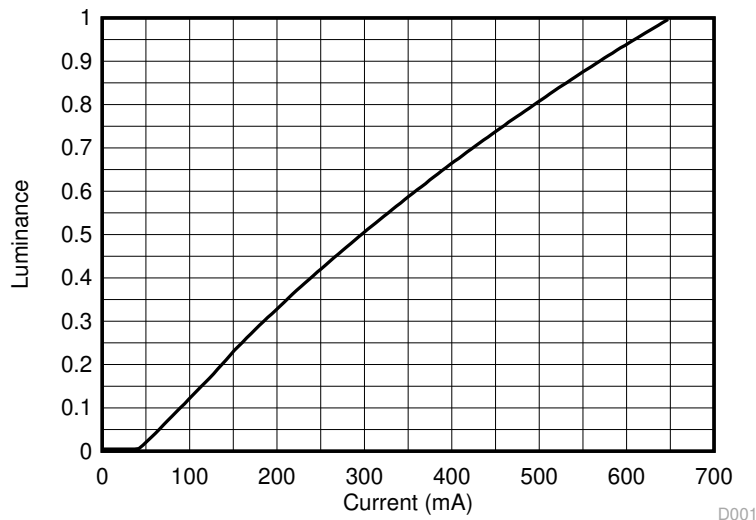
### 8.2.2 Detailed Design Procedure

For connecting together the DLP4710 (.47 1080p) DMD, the 2xDLPC3439 controller, and the DLPA3000/DLPA3005 PMIC/LED driver, see the reference design schematic. When a circuit board layout is created from this schematic, a very small circuit board is possible. An example small board layout is included in the reference design data base. Follow the layout guidelines to achieve a reliable projector.

The optical engine that has the LED packages and the DMD mounted to it is typically supplied by an optical OEM who specializes in designing optics for DLP projectors.

### 8.2.3 Application Curve

As the LED currents that are driven time-sequentially through the red, green, and blue LEDs are increased, the brightness of the projector increases. This increase is somewhat non-linear, and the curve for typical white screen lumens changes with LED currents is shown in Figure 8-2. For the LED currents shown, it is assumed that the same current amplitude is applied to the red, green, and blue LEDs. The shape of the curve depends on the LED devices used as well as the LED system-level heat sink implementation.



**Figure 8-2. Typical Luminance vs Current**

## 9 Power Supply Recommendations

### 9.1 PLL Design Considerations

It is acceptable for the VDD\_PLLD and VDD\_PLLM to be derived from the same regulator as the core VDD. However, to minimize the AC noise component, apply a filter as recommended in the *PLL Power Layout* section.

### 9.2 System Power-Up and Power-Down Sequence

#### 9.2.1

Although the DLPC34xx controller requires an array of power supply voltage pins (for example, VDD, VDDL12, VDD\_PLLM/D, VCC18, VCC\_FLSH, and VCC\_INTF), if VDDL12 is tied to the 1.1-V VDD supply (which is assumed to be the typical configuration), then there are no restrictions regarding the relative order of power supply sequencing to avoid damaging the DLPC34xx controller (this remains true for both power-up and power-down scenarios). The controller requires no minimum delay time between powering-up and powering-down the individual supplies if the VDDL12 is tied to the 1.1-V VDD supply.

However, if the VDDL12 pin is not tied to the VDD supply, then the VDDL12 pin must be powered-on only after the VDD supply is powered-on. And in a similar sequence, the VDDL12 pin must be powered-off before the VDD supply is powered-off. If the VDDL12 pin is not tied to VDD, then the VDDL12 pin and VDD supply pins must be powered-on or powered-off within 100 ms of each other.

Although there is no risk of damaging the DLPC34xx controller when the above power sequencing rules are followed, these additional power sequencing recommendations must be considered to ensure proper system operation:

- To ensure that the DLPC34xx controller output signal states behave as expected, all controller I/O supplies are encouraged to remain applied while VDD core power is applied. If VDD core power is removed while the I/O supply (VCC\_INTF) is applied, then the output signal states associated with the inactive I/O supply go to a high impedance state.
- Because additional power sequencing rules may exist for devices that share the supplies with the DLPC34xx controller (such as the PMIC and DMD), these devices may force additional system power sequencing requirements.

Figure 9-1, Figure 9-2, and Figure 9-3 show the DLPC34xx power-up sequence, the normal PARK power-down sequence, and the fast PARK power-down sequence of a typical DLPC34xx system.

When the VDD core power is applied, but I/O power is not applied, the controller may draw additional leakage current. This leakage current does not affect the normal DLPC34xx controller operation or reliability.

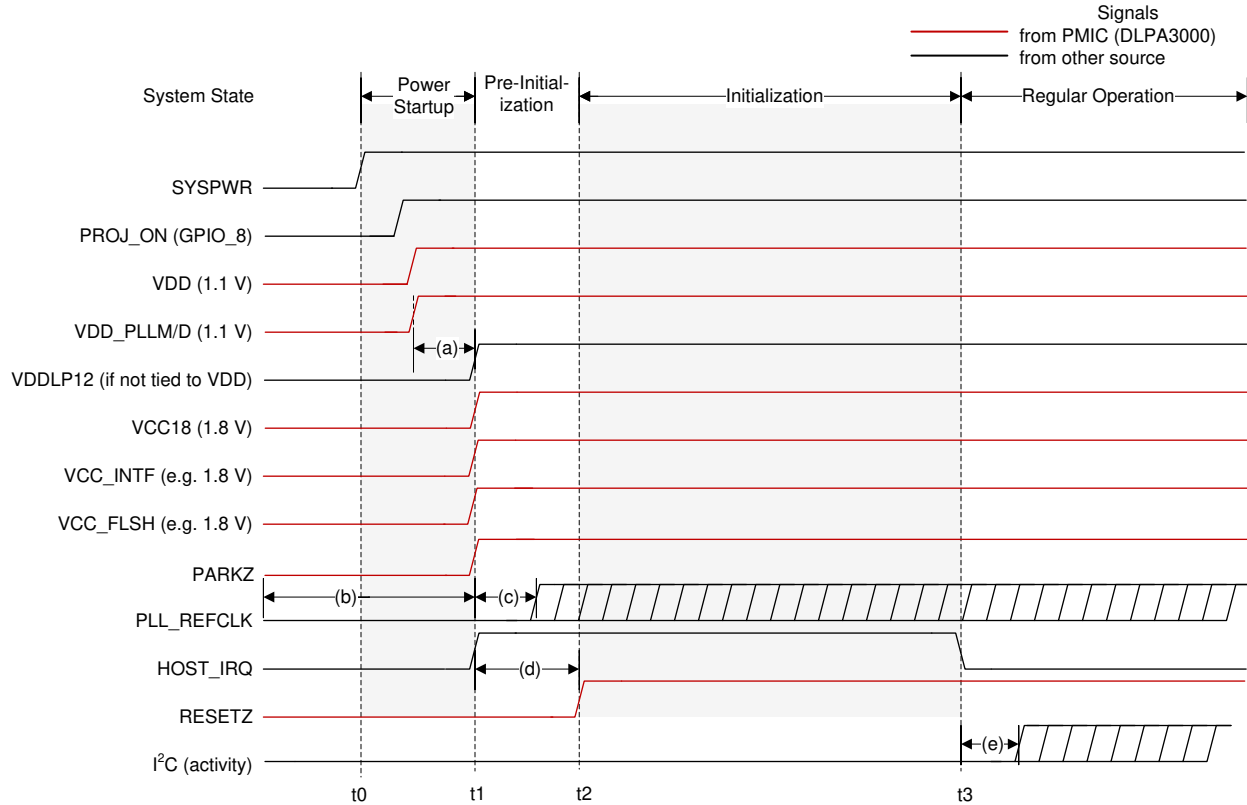
---

#### Note

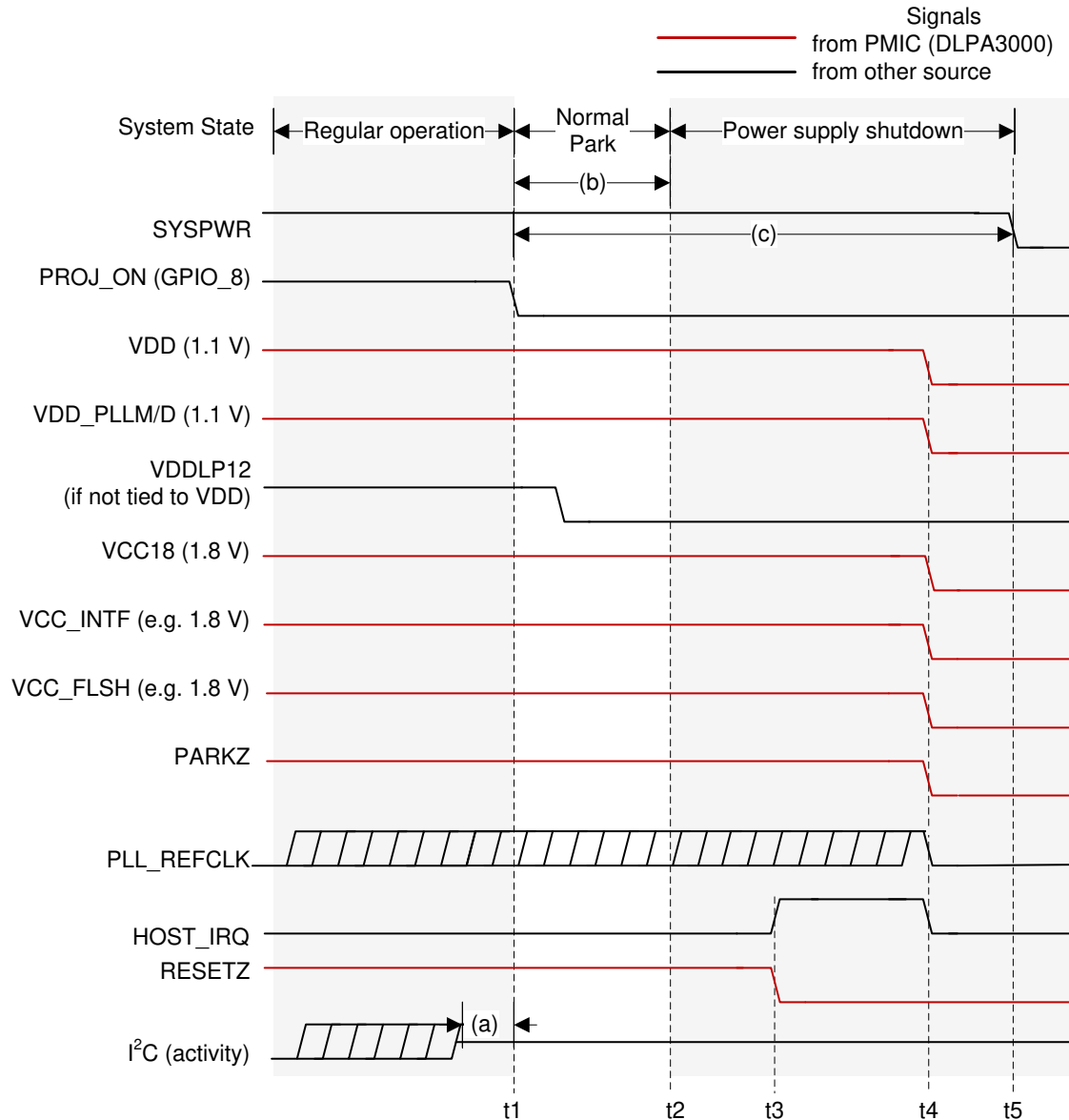
During a Normal Park it is recommended to maintain SYSPWR within specification for at least 50 ms after PROJ\_ON goes low. This is to allow the DMD to be parked and the power supply rails to safely power down. After 50 ms, SYSPWR can be turned off. If a DLPA200x is used, it is also recommended that the 1.8-V supply fed into the DLPA200x load switch be maintained within specification for at least 50 ms after PROJ\_ON goes low.

---



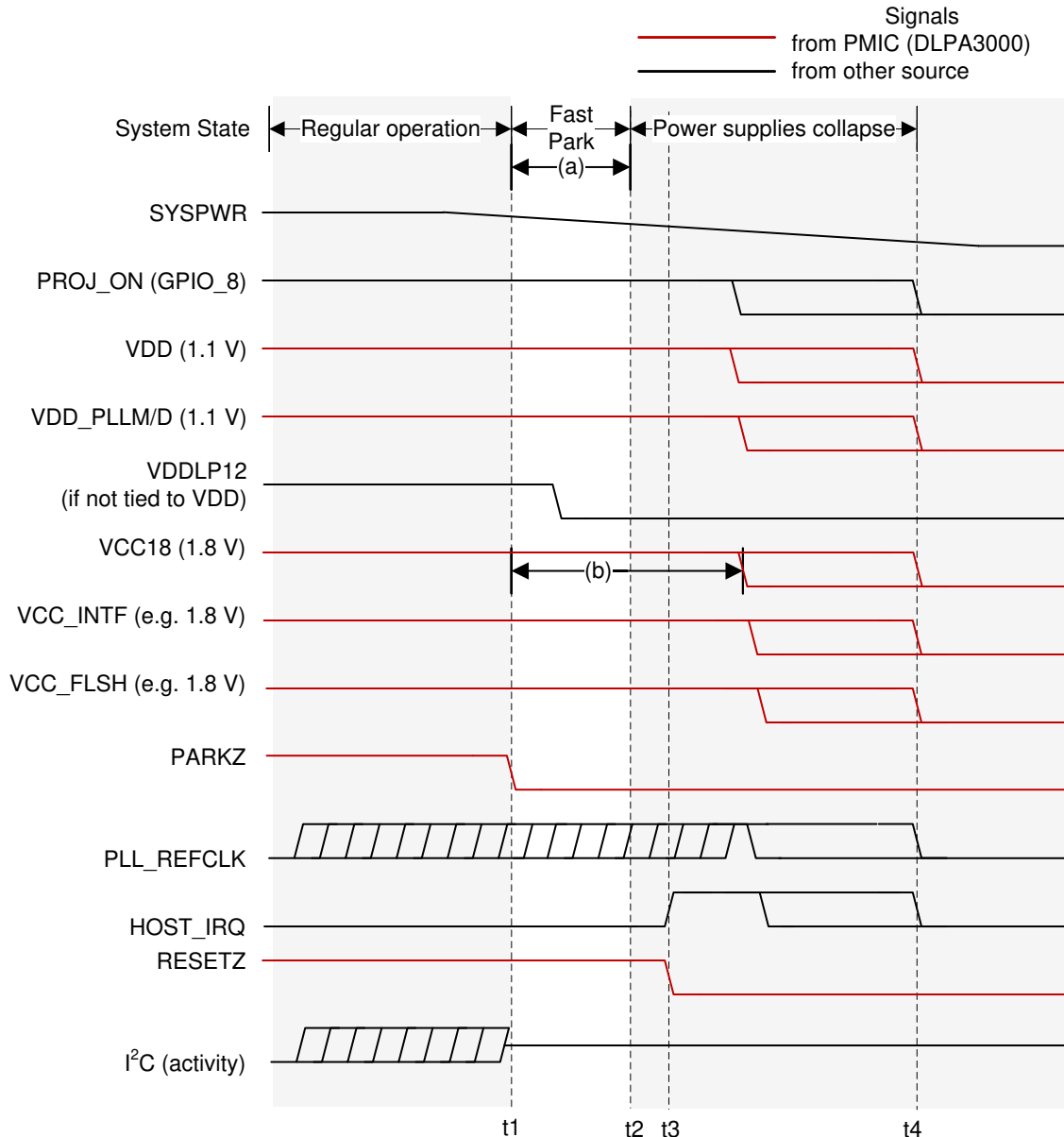


**Figure 9-1. System Power-Up Waveforms (With DLPA3000)**



- t1: PROJ\_ON goes low to begin the power down sequence.
- t2: The controller finishes parking the DMD.
- t3: RESETZ is asserted which causes HOST\_IRQ to be pulled high.
- t4: All controller power supplies are turned off.
- t5: SYSPWR is removed now that all other supplies are turned off.
- (a): I<sup>2</sup>C activity must stop before PROJ\_ON is deasserted (goes low).
- (b): The DMD will be parked within 20 ms of PROJ\_ON being deasserted (going low). VDD, VDD\_PLLM/D, VCC18, VCC\_INITF, and VCC\_FLSH power supplies and the PLL\_REFCLK must be held within specification for a minimum of 20 ms after PROJ\_ON is deasserted (goes low). However, 20 ms does not satisfy the typical shutdown timing of the entire chipset. It is therefore recommended to follow note (c).
- (c): It is recommended that SYSPWR not be turned off for 50 ms after PROJ\_ON is deasserted (goes low). This time allows the DMD to be parked, the controller to turn off, and the PMIC supplies to shut down.

**Figure 9-2. Normal Park Power-Down Waveforms**



- t1: A fault is detected (in this example the PMIC detects a UVLO condition) and PARKZ is asserted (goes low) to tell the controller to initiate a fast park of the DMD.
- t2: The controller finishes the fast park procedure.
- t3: RESETZ is asserted which puts the controller in a reset state which causes HOST\_IRQ to be pulled high.
- t4: Eventually all power supplies that were derived from SYSPWR collapse.
- (a): VDD, VDD\_PLLM/D, VCC18, VCC\_INITF, and VCC\_FLSH power supplies and the PLL\_REFCLK must be held within specification for a minimum of 32  $\mu$ s after PARKZ is asserted (goes low).
- (b): VCC18 must remain in specification long enough to satisfy DMD power sequencing requirements defined in the DMD datasheet. Also see the DLPxxxx datasheets for more information.

**Figure 9-3. Fast Park Power-Down Waveforms**

### 9.3 Power-Up Initialization Sequence

An external power monitor is required to hold the DLPC34xx controller in system reset during the power-up sequence by driving RESETZ to a logic-low state. It shall continue to drive RESETZ low until all controller voltages reach the minimum specified voltage levels, PARKZ goes high, and the input clocks are stable. The external power monitoring is automatically done by the DLPxxxx PMIC.

No signals output by the DLPC34xx controller will be in their active state while RESETZ is asserted. The following signals are tri-stated while RESETZ is asserted:

- SPI0\_CLK
- SPI0\_DOUT
- SPI0\_CSZ0
- SPI0\_CSZ1
- GPIO [19:00]

Add external pullup (or pulldown) resistors to all tri-stated output signals (including bidirectional signals to be configured as outputs) to avoid floating controller outputs during reset if they are connected to devices on the PCB that can malfunction. For SPI, at a minimum, include a pullup to any chip selects connected to devices. Unused bidirectional signals can be configured as outputs in order to avoid floating controller inputs after RESETZ is set high.

The following signals are forced to a logic low state while RESETZ is asserted and the corresponding I/O power is applied:

- LED\_SEL\_0
- LED\_SEL\_1
- DMD\_DEN\_ARSTZ

After power is stable and the PLL\_REFCLK\_I clock input to the DLPC34xx controller is stable, then RESETZ should be deactivated (set to a logic high). The DLPC34xx controller then performs a power-up initialization routine that first locks its PLL followed by loading self configuration data from the external flash. Upon release of RESETZ, all DLPC34xx I/Os will become active. Immediately following the release of RESETZ, the HOST\_IRQ signal will be driven high to indicate that the auto initialization routine is in progress. However, since a pullup resistor is connected to signal HOST\_IRQ, this signal will have already gone high before the controller actively drives it high. Upon completion of the auto-initialization routine, the DLPC34xx controller will drive HOST\_IRQ low to indicate the initialization done state of the controller has been reached.

To ensure reliable operation, during the power-up initialization sequence, GPIO\_08 (PROJ\_ON) must not be deasserted. In other words, once the startup routine has begun (by asserting PROJ\_ON), the startup routine must complete (indicated by HOST\_IRQ going low) before the controller can be commanded off (by deasserting PROJ\_ON).

---

#### Note

No I<sup>2</sup>C or DSI (if applicable) activity is permitted until HOST\_IRQ goes low.

---

### 9.4 DMD Fast Park Control (PARKZ)

PARKZ is an input early warning signal that must alert the controller at least 32  $\mu$ s before DC supply voltages drop below specifications. Typically, the PARKZ signal is provided by the DLPxxxx interrupt output signal. PARKZ must be deasserted (set high) prior to releasing RESETZ (that is, prior to the low-to-high transition on the RESETZ input) for normal operation. When PARKZ is asserted (set low) the controller performs a Fast Park operation on the DMD which assists in maintaining the lifetime of the DMD. The reference clock must continue running and RESETZ must remain deactivated for at least 32  $\mu$ s after PARKZ has been asserted (set low) to allow the park operation to complete.

Fast Park operation is only intended for use when loss of power is imminent and beyond the control of the host processor (for example, when the external power source has been disconnected or the battery has dropped below a minimum level). The longest lifetime of the DMD may not be achieved with Fast Park operation. The

longest lifetime is achieved with a Normal Park operation (initiated through GPIO\_08). Hence, PARKZ is typically only used instead of a Normal Park request if there is not enough time for a Normal Park. A Normal Park operation takes much longer than 32  $\mu$ s to park the mirrors. During a Normal Park operation, the DLPxxxx keeps on all power supplies, and keeps RESETZ high, until the longer mirror parking has completed. Additionally, the DLPxxxx may hold the supplies on for a period of time after the parking has been completed. View the relevant DLPxxxx datasheet for more information. The longer mirror parking time ensures the longest DMD lifetime and reliability. The *DMD Parking Switching Characteristics* section specifies the park timings.

## 9.5 Hot Plug I/O Usage

The DLPC34xx controller provides fail-safe I/O on all host interface signals (signals powered by VCC\_INTF). This allows these inputs to externally be driven even when no I/O power is applied. Under this condition, the controller does not load the input signal nor draw excessive current that could degrade controller reliability. For example, the I<sup>2</sup>C bus from the host to other components is not affected by powering off VCC\_INTF to the DLPC34xx controller. This allows additional devices on the I<sup>2</sup>C bus to be utilized even if the controller is not powered on. TI recommends weak pullup or pulldown resistors to avoid floating inputs for signals that feed back to the host.

If the I/O supply (VCC\_INTF) powers off, but the core supply (VDD) remains on, then the corresponding input buffer may experience added leakage current; however, the added leakage current does not damage the DLPC34xx controller.

However, if VCC\_INTF is powered and VDD is not powered, the controller may drive the IIC0\_xx pins low which prevents communication on this I<sup>2</sup>C bus. Do not power up the VCC\_INTF pin before powering up the VDD pin for any system that has additional secondary devices on this bus.

## 10 Layout

### 10.1 Layout Guidelines

For a summary of the PCB design requirements for the DLPC34xx controller see [PCB Design Requirements for TI DLP Pico TRP Digital Micromirror Devices](#). Some applications (such as high frame rate video) may require the use of 1-oz (or greater) copper planes to manage the controller package heat.

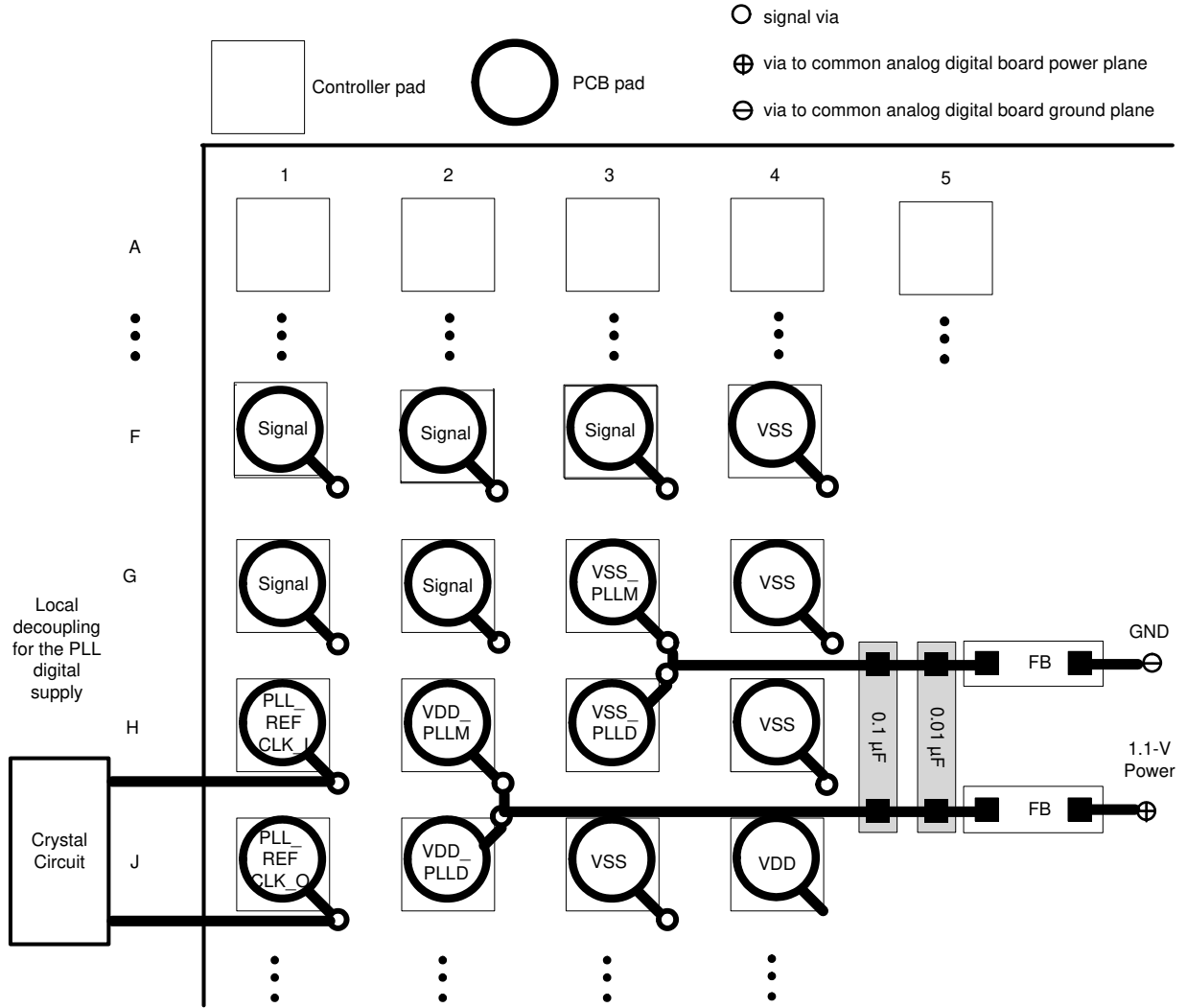
#### 10.1.1 PLL Power Layout

Follow these recommended guidelines to achieve acceptable controller performance for the internal PLL. The DLPC34xx controller contains two internal PLLs which have dedicated analog supplies (VDD\_PLLM, VSS\_PLLM, VDD\_PLLD, and VSS\_PLLD). At a minimum, isolate the VDD\_PLLx power and VSS\_PLLx ground pins using a simple passive filter consisting of two series ferrite beads and two shunt capacitors (to widen the spectrum of noise absorption). It is recommended that one capacitor be 0.1  $\mu\text{F}$  and one be 0.01  $\mu\text{F}$ . Place all four components as close to the controller as possible. It is especially important to keep the leads of the high frequency capacitors as short as possible. Connect both capacitors from VDD\_PLLM to VSS\_PLLM and VDD\_PLLD to VSS\_PLLD on the controller side of the ferrite beads.

Select ferrite beads with these characteristics:

- DC resistance less than 0.40  $\Omega$
- Impedance at 10 MHz equal to or greater than 180  $\Omega$
- Impedance at 100 MHz equal to or greater than 600  $\Omega$

The PCB layout is critical to PLL performance. It is vital that the quiet ground and power are treated like analog signals. Therefore, VDD\_PLLM and VDD\_PLLD must be a single trace from the DLPC34xx controller to both capacitors and then through the series ferrites to the power source. Make the power and ground traces as short as possible, parallel to each other, and as close as possible to each other.

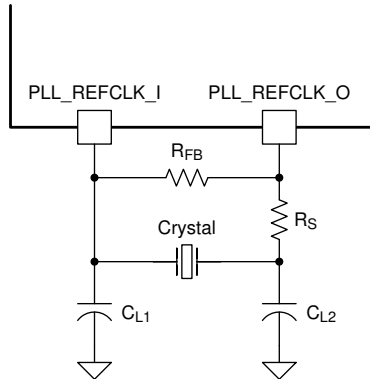


**Figure 10-1. PLL Filter Layout**

### 10.1.2 Reference Clock Layout

The DLPC34xx controller requires an external reference clock to feed the internal PLL. Use either a crystal or oscillator to supply this reference. The DLPC34xx reference clock must not exceed a frequency variation of  $\pm 200$  ppm (including aging, temperature, and trim component variation).

Figure 10-2 shows the required discrete components when using a crystal.



$C_L$  = Crystal load capacitance (farads)

$C_{L1} = 2 \times (C_L - C_{stray\_pll\_refclk\_i})$

$C_{L2} = 2 \times (C_L - C_{stray\_pll\_refclk\_o})$

where:

- $C_{stray\_pll\_refclk\_i}$  = Sum of package and PCB stray capacitance at the crystal pin associated with the controller pin `pll_refclk_i`.
- $C_{stray\_pll\_refclk\_o}$  = Sum of package and PCB stray capacitance at the crystal pin associated with the controller pin `pll_refclk_o`.

**Figure 10-2. Required Discrete Components**

### 10.1.2.1 Recommended Crystal Oscillator Configuration

**Table 10-1. Crystal Port Characteristics**

PARAMETER	NOM	UNIT
PLL_REFCLK_I TO GND capacitance	1.5	pF
PLL_REFCLK_O TO GND capacitance	1.5	pF

**Table 10-2. Recommended Crystal Configuration**

PARAMETER <sup>(1)</sup> <sup>(2)</sup>	RECOMMENDED	UNIT
Crystal circuit configuration	Parallel resonant	
Crystal type	Fundamental (first harmonic)	
Crystal nominal frequency	24	MHz
Crystal frequency tolerance (including accuracy, temperature, aging and trim sensitivity)	±200	PPM
Maximum startup time	1.0	ms
Crystal equivalent series resistance (ESR)	120 (max)	Ω
Crystal load	6	pF
$R_S$ drive resistor (nominal)	100	Ω
$R_{FB}$ feedback resistor (nominal)	1	MΩ
$C_{L1}$ external crystal load capacitor	See equation in <a href="#">Figure 1-1</a> notes	pF
$C_{L2}$ external crystal load capacitor	See equation in <a href="#">Figure 1-1</a> notes	pF
PCB layout	A ground isolation ring around the crystal is recommended	

(1) Temperature range of –30°C to 85°C.

(2) The crystal bias is determined by the controllers VCC\_INTF voltage rail, which is variable (not the VCC18 rail).

If an external oscillator is used, then the oscillator output must drive the PLL\_REFCLK\_I pin on the DLPC34xx controller, and the PLL\_REFCLK\_O pin must be left unconnected.



**Table 10-3. Recommended Crystal Parts**

MANUFACTURER (1) (2)	PART NUMBER	SPEED (MHz)	TEMPERATURE AND AGING (ppm)	MAXIMUM ESR ( $\Omega$ )	LOAD CAPACITANCE (pF)	PACKAGE DIMENSIONS (mm)
KDS	DSX211G-24.000M-8pF-50-50	24	$\pm 50$	120	8	2.0 × 1.6
Murata	XRCGB24M000F0L11R0	24	$\pm 100$	120	6	2.0 × 1.6
NDK	NX2016SA 24M EXS00A-CS05733	24	$\pm 145$	120	6	2.0 × 1.6

- (1) The crystal devices in this table have been validated to work with the DLPC34xx controller. Other devices may also be compatible but have not necessarily been validated by TI.
- (2) Operating temperature range:  $-30^{\circ}\text{C}$  to  $85^{\circ}\text{C}$  for all crystals.

### 10.1.3 Unused Pins

To avoid potentially damaging current caused by floating CMOS input-only pins, TI recommends tying unused controller input pins through a pullup resistor to its associated power supply or a pulldown resistor to ground. For controller inputs with internal pullup or pulldown resistors, it is unnecessary to add an external pullup or pulldown unless specifically recommended. Note that internal pullup and pulldown resistors are weak and should not be expected to drive an external device. The DLPC34xx controller implements very few internal resistors and are listed in the tables found in the *Pin Configuration and Functions* section. When external pullup or pulldown resistors are needed for pins that have weak pullup or pulldown resistors, choose a maximum resistance of 8 k $\Omega$ .

Never tie unused output-only pins directly to power or ground. Leave them open.

When possible, TI recommends that unused bidirectional I/O pins are configured to their output state such that the pin can remain open. If this control is not available and the pins may become an input, then include an appropriate pullup (or pulldown) resistor.

## 10.1.4 DMD Control and Sub-LVDS Signals

**Table 10-4. Maximum Pin-to-Pin PCB Interconnect Recommendations**

DMD BUS SIGNAL <sup>(1)</sup> <sup>(2)</sup>	SIGNAL INTERCONNECT TOPOLOGY		UNIT
	SINGLE-BOARD SIGNAL ROUTING LENGTH	MULTI-BOARD SIGNAL ROUTING LENGTH	
DMD_HS_CLK_P DMD_HS_CLK_N	6.0 (152.4)	See <sup>(3)</sup>	in (mm)
DMD_HS_WDATA_A_P DMD_HS_WDATA_A_N	6.0 (152.4)	See <sup>(3)</sup>	in (mm)
DMD_HS_WDATA_B_P DMD_HS_WDATA_B_N			
DMD_HS_WDATA_C_P DMD_HS_WDATA_C_N			
DMD_HS_WDATA_D_P DMD_HS_WDATA_D_N			
DMD_HS_WDATA_E_P DMD_HS_WDATA_E_N			
DMD_HS_WDATA_F_P DMD_HS_WDATA_F_N			
DMD_HS_WDATA_G_P DMD_HS_WDATA_G_N			
DMD_HS_WDATA_H_P DMD_HS_WDATA_H_N			
DMD_LS_CLK			
DMD_LS_WDATA	6.5 (165.1)	See <sup>(3)</sup>	in (mm)
DMD_LS_RDATA	6.5 (165.1)	See <sup>(3)</sup>	in (mm)
DMD_DEN_ARSTZ	7.0 (177.8)	See <sup>(3)</sup>	in (mm)

(1) Maximum signal routing length includes escape routing.

(2) Multi-board DMD routing length is more restricted due to the impact of the connector.

(3) Due to PCB variations, these recommendations cannot be defined. Any board design should SPICE simulate with the controller IBIS model (found under the *Tools & Software* tab of the controller web page) to ensure routing lengths do not violate signal requirements.

**Table 10-5. High Speed PCB Signal Routing Matching Requirements**

SIGNAL GROUP LENGTH MATCHING <sup>(1) (2) (3)</sup>				
INTERFACE	SIGNAL GROUP	REFERENCE SIGNAL	MAX MISMATCH <sup>(4)</sup>	UNIT
DMD <sup>(5)</sup>	DMD_HS_WDATA_A_P DMD_HS_WDATA_A_N	DMD_HS_CLK_P DMD_HS_CLK_N	±1.0 (±25.4)	in (mm)
	DMD_HS_WDATA_B_P DMD_HS_WDATA_B_N			
	DMD_HS_WDATA_C_P DMD_HS_WDATA_C_N			
	DMD_HS_WDATA_D_P DMD_HS_WDATA_D_N			
	DMD_HS_WDATA_E_P DMD_HS_WDATA_E_N			
	DMD_HS_WDATA_F_P DMD_HS_WDATA_F_N			
	DMD_HS_WDATA_G_P DMD_HS_WDATA_G_N			
	DMD_HS_WDATA_H_P DMD_HS_WDATA_H_N			
DMD	DMD_HS_WDATA_x_P	DMD_HS_WDATA_x_N	±0.025 (±0.635)	in (mm)
DMD	DMD_HS_CLK_P	DMD_HS_CLK_N	±0.025 (±0.635)	in (mm)
DMD	DMD_LS_WDATA DMD_LS_RDATA	DMD_LS_CLK	±0.2 (±5.08)	in (mm)
DMD	DMD_DEN_ARSTZ	N/A	N/A	in (mm)

- (1) The length matching values apply to PCB routing lengths only. Internal package routing mismatch associated with the DLPC34xx controller or the DMD require no additional consideration.
- (2) Training is applied to DMD HS data lines. This is why the defined matching requirements are slightly relaxed compared to the LS data lines.
- (3) DMD LS signals are single ended.
- (4) Mismatch variance for a signal group is always with respect to the reference signal.
- (5) DMD HS data lines are differential, thus these specifications are pair-to-pair.

**Table 10-6. Signal Requirements**

PARAMETER	REFERENCE	REQUIREMENT
Source series termination	DMD_LS_WDATA	Required
	DMD_LS_CLK	Required
	DMD_DEN_ARSTZ	Acceptable
	DMD_LS_RDATA	Required
	DMD_HS_WDATA_x_y	Not acceptable
	DMD_HS_CLK_y	Not acceptable
Endpoint termination	DMD_LS_WDATA	Not acceptable
	DMD_LS_CLK	Not acceptable
	DMD_DEN_ARSTZ	Not acceptable
	DMD_LS_RDATA	Not acceptable
	DMD_HS_WDATA_x_y	Not acceptable
	DMD_HS_CLK_y	Not acceptable
PCB impedance	DMD_LS_WDATA	68 $\Omega$ $\pm$ 10%
	DMD_LS_CLK	68 $\Omega$ $\pm$ 10%
	DMD_DEN_ARSTZ	68 $\Omega$ $\pm$ 10%
	DMD_LS_RDATA	68 $\Omega$ $\pm$ 10%
	DMD_HS_WDATA_x_y	100 $\Omega$ $\pm$ 10%
	DMD_HS_CLK_y	100 $\Omega$ $\pm$ 10%
Signal type	DMD_LS_WDATA	SDR (single data rate) referenced to DMD_LS_DCLK
	DMD_LS_CLK	SDR referenced to DMD_LS_DCLK
	DMD_DEN_ARSTZ	SDR
	DMD_LS_RDATA	SDR referenced to DMD_LS_DCLK
	DMD_HS_WDATA_x_y	sub-LVDS
	DMD_HS_CLK_y	sub-LVDS

### 10.1.5 Layer Changes

- Single-ended signals: Minimize the number of layer changes.
- Differential signals: Individual differential pairs can be routed on different layers. Ideally ensure that the signals of a given pair do not change layers.

### 10.1.6 Stubs

- Avoid using stubs.

### 10.1.7 Terminations

- DMD\_HS differential signals require no external termination resistors.
- Make sure the DMD\_LS\_CLK and DMD\_LS\_WDATA signal paths include a 43- $\Omega$  series termination resistor located as close as possible to the corresponding controller pins.
- Make sure the DMD\_LS\_RDATA signal path includes a 43- $\Omega$  series termination resistor located as close as possible to the corresponding DMD pin.
- The DMD\_DEN\_ARSTZ pin requires no series resistor.

### 10.1.8 Routing Vias

- The number of vias on DMD\_HS signals must be minimized and ideally not exceed two.
- Any and all vias on DMD\_HS signals must be located as close to the controller as possible.
- The number of vias on the DMD\_LS\_CLK and DMD\_LS\_WDATA signals must be minimized and ideally not exceed two.

- Any and all vias on the DMD\_LS\_CLK and DMD\_LS\_WDATA signals must be located as close to the controller as possible.

### 10.1.9 Thermal Considerations

The underlying thermal limitation for the DLPC34xx controller is that the maximum operating junction temperature ( $T_J$ ) not be exceeded (this is defined in the *Recommended Operating Conditions* section).

Some factors that influence  $T_J$  are as follows:

- operating ambient temperature
- airflow
- PCB design (including the component layout density and the amount of copper used)
- power dissipation of the DLPC34xx controller
- power dissipation of surrounding components

The controller package is designed to primarily extract heat through the power and ground planes of the PCB. Thus, copper content and airflow over the PCB are important factors.

The recommended maximum operating ambient temperature ( $T_A$ ) is provided primarily as a design target and is based on maximum DLPC34xx controller power dissipation and  $R_{\theta JA}$  at 0 m/s of forced airflow, where  $R_{\theta JA}$  is the thermal resistance of the package as measured using a JEDEC defined standard test PCB with two, 1-oz power planes. This JEDEC test PCB is not necessarily representative of the DLPC34xx controller PCB, so the reported thermal resistance may not be accurate in the actual product application. Although the actual thermal resistance may be different, it is the best information available during the design phase to estimate thermal performance. TI highly recommends that thermal performance be measured and validated after the PCB is designed and the application is built.

To evaluate the thermal performance, measure the top center case temperature under the worse case product scenario (maximum power dissipation, maximum voltage, maximum ambient temperature), and validate the controller does not exceed the maximum recommended case temperature ( $T_C$ ). This specification is based on the measured  $\phi_{JT}$  for the DLPC34xx controller package and provides a relatively accurate correlation to junction temperature.

Take care when measuring this case temperature to prevent accidental cooling of the package surface. TI recommends a small (approximately 40 gauge) thermocouple. Place the bead and thermocouple wire so that they contact the top of the package. Cover the bead and thermocouple wire with a minimal amount of thermally conductive epoxy. Route the wires closely along the package and the board surface to avoid cooling the bead through the wires.

## 10.2 Layout Example

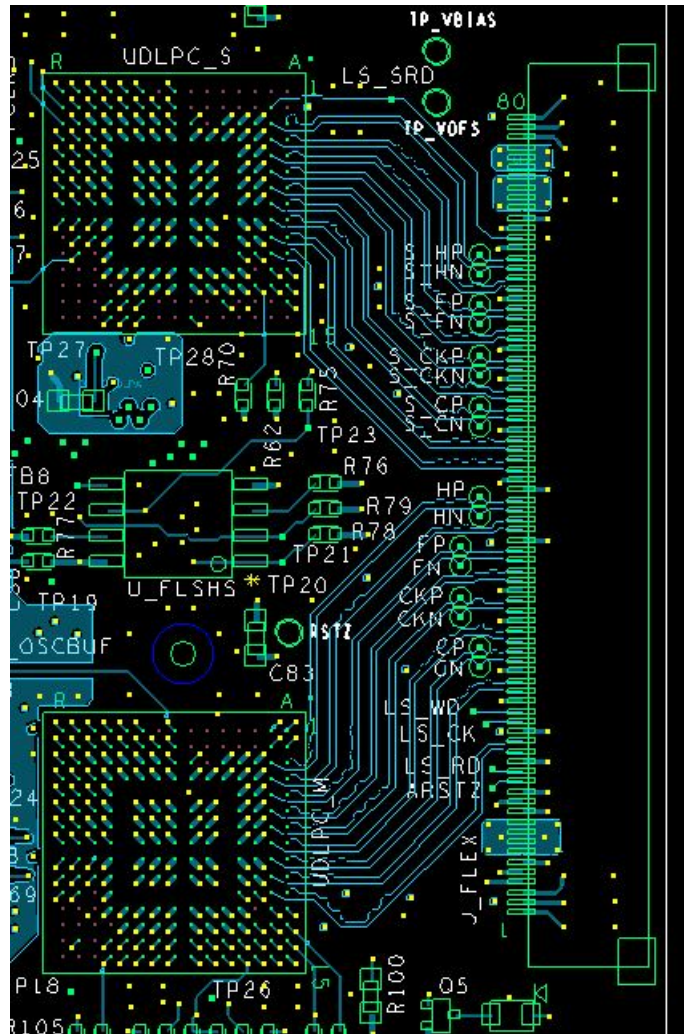


Figure 10-3. Board Layout

## 11 Device and Documentation Support

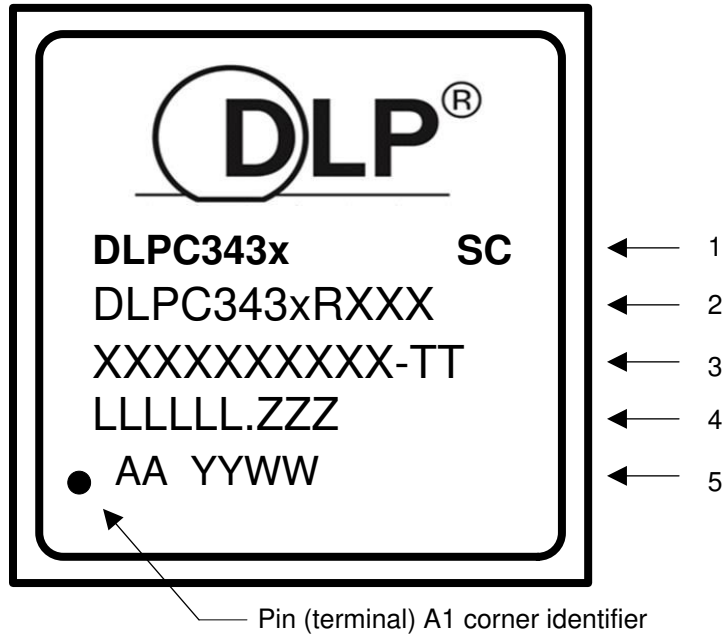
### 11.1 Device Support

#### 11.1.1 Third-Party Products Disclaimer

TI'S PUBLICATION OF INFORMATION REGARDING THIRD-PARTY PRODUCTS OR SERVICES DOES NOT CONSTITUTE AN ENDORSEMENT REGARDING THE SUITABILITY OF SUCH PRODUCTS OR SERVICES OR A WARRANTY, REPRESENTATION OR ENDORSEMENT OF SUCH PRODUCTS OR SERVICES, EITHER ALONE OR IN COMBINATION WITH ANY TI PRODUCT OR SERVICE.

#### 11.1.2 Device Nomenclature

##### 11.1.2.1 Device Markings



#### Marking Definitions:

- Line 1: DLP® Device Name: DLPC343x = x indicates a 9 device name ID.  
SC: Solder ball composition  
e1: Indicates lead-free solder balls consisting of SnAgCu  
G8: Indicates lead-free solder balls consisting of tin-silver-copper (SnAgCu) with silver content less than or equal to 1.5% and that the mold compound meets TI's definition of green.
- Line 2: TI Part Number  
DLP® Device Name: DLPC343x = x indicates a 9 device name ID.  
R corresponds to the TI device revision letter for example A, B, or C.  
XXX corresponds to the device package designator.
- Line 3: XXXXXXXXXXXX-TT Manufacturer Part Number
- Line 4: LLLLLLLL.ZZZ Foundry lot code for semiconductor wafers and lead-free solder ball marking  
LLLLLLLL: Fab lot number  
ZZZ: Lot split number
- Line 5: AA YYWW: Package assembly information  
AA corresponds to the manufacturing site  
YYWW: Date code (YY = Year :: WW = Week)

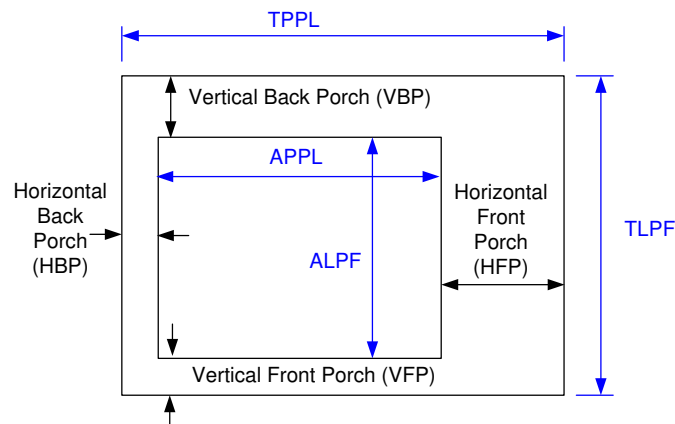
#### Note

Engineering prototype samples are marked with an **X** suffix appended to the TI part number. For example, 2512737-0001X.

### 11.1.2.2 Video Timing Parameter Definitions

See [Figure 11-1](#) for a visual description.

- Active Lines Per Frame (ALPF)** Defines the number of lines in a frame containing displayable data. ALPF is a subset of the TLPF.
- Active Pixels Per Line (APPL)** Defines the number of pixel clocks in a line containing displayable data. APPL is a subset of the TPPL.
- Horizontal Back Porch (HBP) Blanking** Defines the number of blank pixel clocks after the active edge of horizontal sync but before the first active pixel.
- Horizontal Front Porch (HFP) Blanking** Defines the number of blank pixel clocks after the last active pixel but before horizontal sync.
- Horizontal Sync (HS or Hsync)** Timing reference point that defines the start of each horizontal interval (line). The active edge of the HS signal defines the absolute reference point. The active edge (either rising or falling edge as defined by the source) is the reference from which all horizontal blanking parameters are measured.
- Total Lines Per Frame (TLPF)** Total number of active and inactive lines per frame; defines the vertical period (or frame time).
- Total Pixel Per Line (TPPL)** Total number of active and inactive pixel clocks per line; defines the horizontal line period in pixel clocks.
- Vertical Sync (VS or Vsync)** Timing reference point that defines the start of the vertical interval (frame). The absolute reference point is defined by the active edge of the VS signal. The active edge (either rising or falling edge as defined by the source) is the reference from which all vertical blanking parameters are measured.
- Vertical Back Porch (VBP) Blanking** Defines the number of blank lines after the active edge of vertical sync but before the first active line.
- Vertical Front Porch (VFP) Blanking** Defines the number of blank lines after the last active line but before the active edge of vertical sync.



**Figure 11-1. Parameter Definitions**



## 11.2 Related Documentation

The following table lists quick access links for associated parts of the DLP chipset.

**Table 11-1. Chipset Documentation**

PARTS	PRODUCT FOLDER	SAMPLE & BUY	TECHNICAL DOCUMENTS	TOOLS & SOFTWARE
DLPA3000	<a href="#">Click here</a>	<a href="#">Click here</a>	<a href="#">Click here</a>	<a href="#">Click here</a>
DLPA3005	<a href="#">Click here</a>	<a href="#">Click here</a>	<a href="#">Click here</a>	<a href="#">Click here</a>
DLP4710	<a href="#">Click here</a>	<a href="#">Click here</a>	<a href="#">Click here</a>	<a href="#">Click here</a>

## 11.3 Related Links

The table below lists quick access links. Categories include technical documents, support and community resources, tools and software, and quick access to order now.

**Table 11-2. Related Links**

PARTS	PRODUCT FOLDER	ORDER NOW	TECHNICAL DOCUMENTS	TOOLS & SOFTWARE	SUPPORT & COMMUNITY
DLPC3470	<a href="#">Click here</a>	<a href="#">Click here</a>	<a href="#">Click here</a>	<a href="#">Click here</a>	<a href="#">Click here</a>

## 11.4 Receiving Notification of Documentation Updates

To receive notification of documentation updates, navigate to the device product folder on [ti.com](#). Click on *Subscribe to updates* to register and receive a weekly digest of any product information that has changed. For change details, review the revision history included in any revised document.

## 11.5 Support Resources

[TI E2E™ support forums](#) are an engineer's go-to source for fast, verified answers and design help — straight from the experts. Search existing answers or ask your own question to get the quick design help you need.

Linked content is provided "AS IS" by the respective contributors. They do not constitute TI specifications and do not necessarily reflect TI's views; see TI's [Terms of Use](#).

## 11.6 Trademarks

IntelliBright™, Pico™, Link™ are trademarks of Texas Instruments.

TI E2E™ is a trademark of Texas Instruments.

DLP® and IntelliBright® are registered trademarks of Texas Instruments.

Arm® and Cortex® are registered trademarks of Arm Limited (or its subsidiaries) in the US and/or elsewhere.

All trademarks are the property of their respective owners.

## 11.7 Electrostatic Discharge Caution



This integrated circuit can be damaged by ESD. Texas Instruments recommends that all integrated circuits be handled with appropriate precautions. Failure to observe proper handling and installation procedures can cause damage.

ESD damage can range from subtle performance degradation to complete device failure. Precision integrated circuits may be more susceptible to damage because very small parametric changes could cause the device not to meet its published specifications.

## 11.8 Glossary

[TI Glossary](#) This glossary lists and explains terms, acronyms, and definitions.

## 12 Mechanical, Packaging, and Orderable Information

The following pages include mechanical, packaging, and orderable information. This information is the most current data available for the designated devices. This data is subject to change without notice and revision of this document. For browser-based versions of this data sheet, refer to the left-hand navigation.

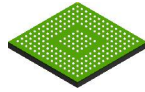
## 12.1 Package Option Addendum

### 12.1.1 Packaging Information

Orderable Device	Status <sup>(1)</sup>	Package Type	Package Drawing	Pins	Package Qty	Eco Plan <sup>(2)</sup>	Lead/Ball Finish	MSL Peak Temp <sup>(3)</sup>	Op Temp (°C)	Device Marking <sup>(4) (5)</sup>
DLPC3439CZEZ	ACTIVE	NFBGA	ZEZ	201	160	Call TI	Call TI	Level-3-260C-168 HRS	-30 to 85	

- (1) The marketing status values are defined as follows:  
**ACTIVE:** Product device recommended for new designs.  
**LIFEBUY:** TI has announced that the device will be discontinued, and a lifetime-buy period is in effect.  
**NRND:** Not recommended for new designs. Device is in production to support existing customers, but TI does not recommend using this part in a new design.  
**PRE\_PROD** Unannounced device, not in production, not available for mass market, nor on the web, samples not available.  
**PREVIEW:** Device has been announced but is not in production. Samples may or may not be available.  
**OBSOLETE:** TI has discontinued the production of the device.
- (2) Eco Plan - The planned eco-friendly classification: Pb-Free (RoHS), Pb-Free (RoHS Exempt), or Green (RoHS & no Sb/Br) - please check <http://www.ti.com/productcontent> for the latest availability information and additional product content details.  
**TBD:** The Pb-Free/Green conversion plan has not been defined.  
**Pb-Free (RoHS):** TI's terms "Lead-Free" or "Pb-Free" mean semiconductor products that are compatible with the current RoHS requirements for all 6 substances, including the requirement that lead not exceed 0.1% by weight in homogeneous materials. Where designed to be soldered at high temperatures, TI Pb-Free products are suitable for use in specified lead-free processes.  
**Pb-Free (RoHS Exempt):** This component has a RoHS exemption for either 1) lead-based flip-chip solder bumps used between the die and package, or 2) lead-based die adhesive used between the die and leadframe. The component is otherwise considered Pb-Free (RoHS compatible) as defined above.  
**Green (RoHS & no Sb/Br):** TI defines "Green" to mean Pb-Free (RoHS compatible), and free of Bromine (Br) and Antimony (Sb) based flame retardants (Br or Sb do not exceed 0.1% by weight in homogeneous material)
- (3) MSL, Peak Temp. -- The Moisture Sensitivity Level rating according to the JEDEC industry standard classifications, and peak solder temperature.
- (4) There may be additional marking, which relates to the logo, the lot trace code information, or the environmental category on the device
- (5) Multiple Device markings will be inside parentheses. Only on Device Marking contained in parentheses and separated by a "~" will appear on a device. If a line is indented then it is a continuation of the previous line and the two combined represent the entire Device Marking for that device.
- Important Information and Disclaimer:** The information provided on this page represents TI's knowledge and belief as of the date that it is provided. TI bases its knowledge and belief on information provided by third parties, and makes no representation or warranty as to the accuracy of such information. Efforts are underway to better integrate information from third parties. TI has taken and continues to take reasonable steps to provide representative and accurate information but may not have conducted destructive testing or chemical analysis on incoming materials and chemicals. TI and TI suppliers consider certain information to be proprietary, and thus CAS numbers and other limited information may not be available for release.
- In no event shall TI's liability arising out of such information exceed the total purchase price of the TI part(s) at issue in this document sold by TI to Customer on an annual basis.

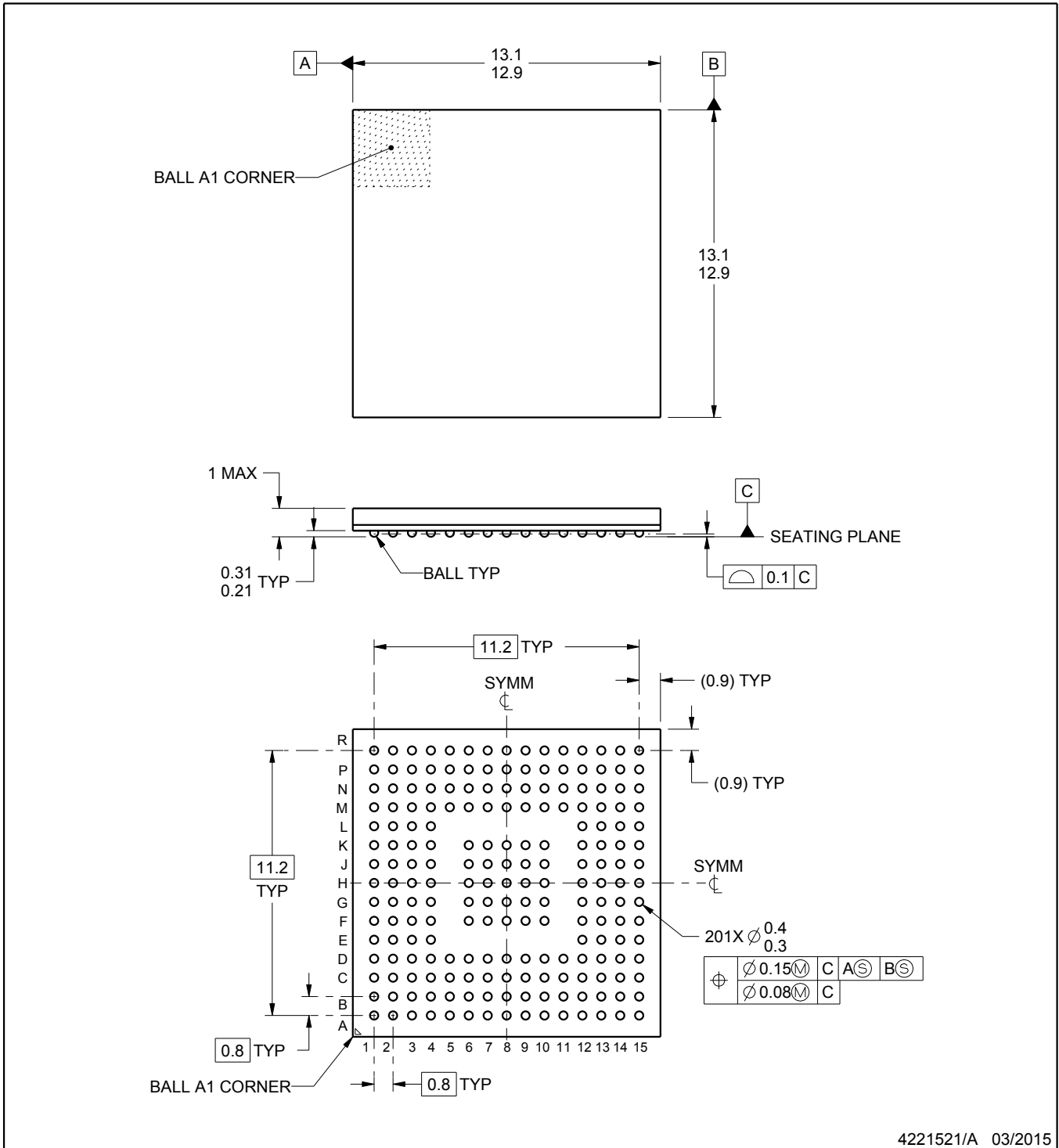
# ZEZ0201A



# PACKAGE OUTLINE

## NFBGA - 1 mm max height

PLASTIC BALL GRID ARRAY



4221521/A 03/2015

### NOTES:

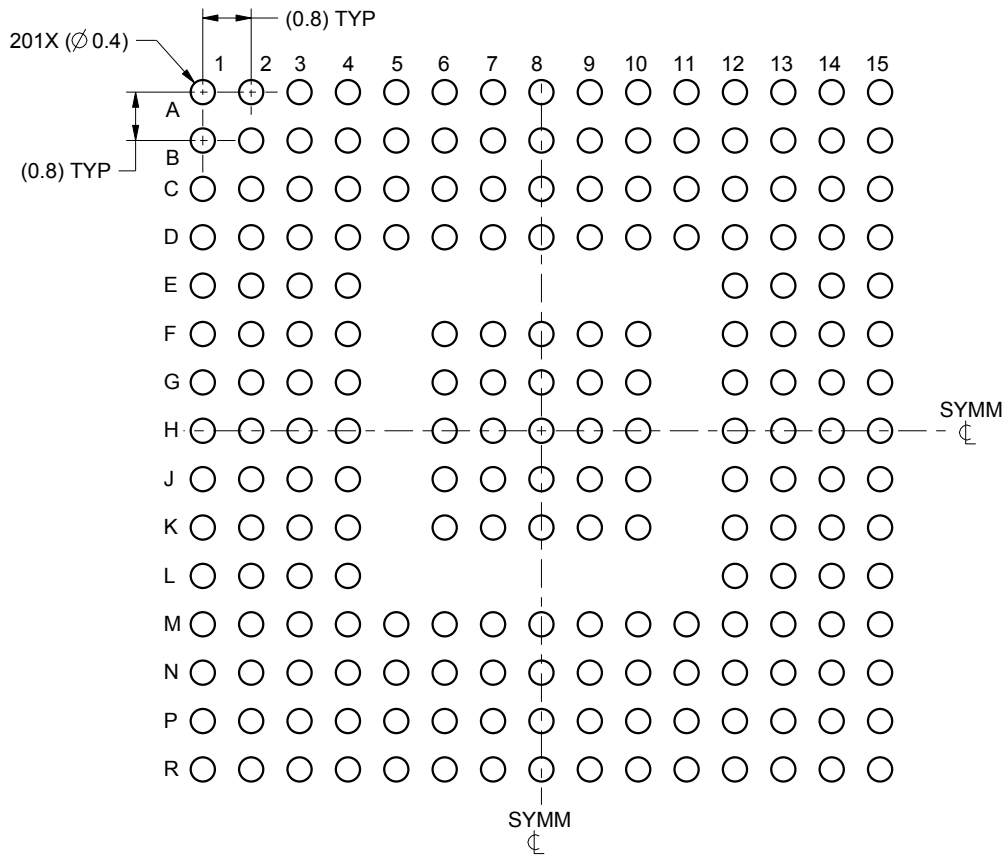
1. All linear dimensions are in millimeters. Any dimensions in parenthesis are for reference only. Dimensioning and tolerancing per ASME Y14.5M.
2. This drawing is subject to change without notice.

# EXAMPLE BOARD LAYOUT

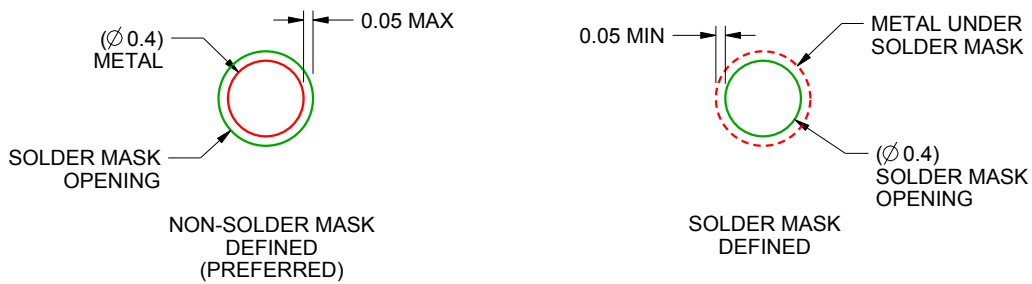
**ZEZ0201A**

**NFBGA - 1 mm max height**

PLASTIC BALL GRID ARRAY



LAND PATTERN EXAMPLE  
SCALE:8X



SOLDER MASK DETAILS  
NOT TO SCALE

4221521/A 03/2015

NOTES: (continued)

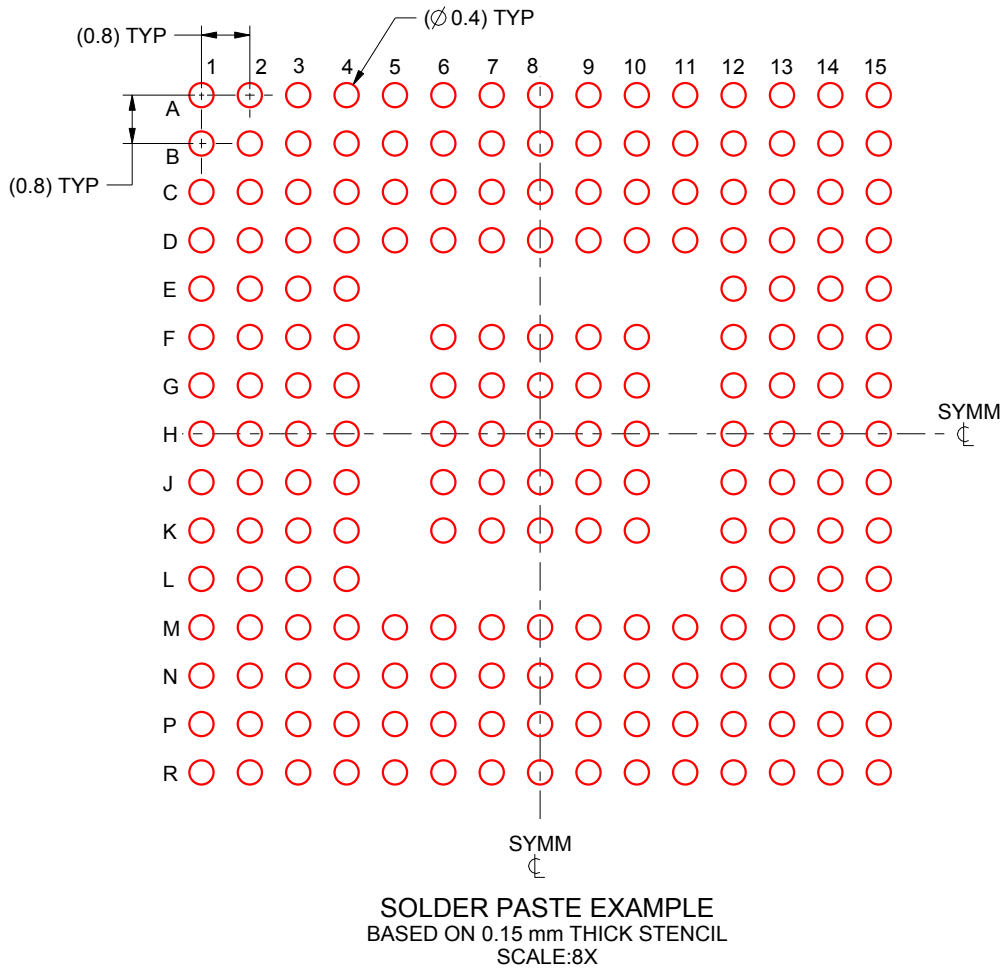
- Final dimensions may vary due to manufacturing tolerance considerations and also routing constraints. For information, see Texas Instruments literature number SPRAA99 ([www.ti.com/lit/spraa99](http://www.ti.com/lit/spraa99)).

# EXAMPLE STENCIL DESIGN

**ZEZ0201A**

**NFBGA - 1 mm max height**

PLASTIC BALL GRID ARRAY



4221521/A 03/2015

NOTES: (continued)

4. Laser cutting apertures with trapezoidal walls and rounded corners may offer better paste release.

## IMPORTANT NOTICE AND DISCLAIMER

TI PROVIDES TECHNICAL AND RELIABILITY DATA (INCLUDING DATASHEETS), DESIGN RESOURCES (INCLUDING REFERENCE DESIGNS), APPLICATION OR OTHER DESIGN ADVICE, WEB TOOLS, SAFETY INFORMATION, AND OTHER RESOURCES "AS IS" AND WITH ALL FAULTS, AND DISCLAIMS ALL WARRANTIES, EXPRESS AND IMPLIED, INCLUDING WITHOUT LIMITATION ANY IMPLIED WARRANTIES OF MERCHANTABILITY, FITNESS FOR A PARTICULAR PURPOSE OR NON-INFRINGEMENT OF THIRD PARTY INTELLECTUAL PROPERTY RIGHTS.

These resources are intended for skilled developers designing with TI products. You are solely responsible for (1) selecting the appropriate TI products for your application, (2) designing, validating and testing your application, and (3) ensuring your application meets applicable standards, and any other safety, security, or other requirements. These resources are subject to change without notice. TI grants you permission to use these resources only for development of an application that uses the TI products described in the resource. Other reproduction and display of these resources is prohibited. No license is granted to any other TI intellectual property right or to any third party intellectual property right. TI disclaims responsibility for, and you will fully indemnify TI and its representatives against, any claims, damages, costs, losses, and liabilities arising out of your use of these resources.

TI's products are provided subject to TI's Terms of Sale (<https://www.ti.com/legal/termsofsale.html>) or other applicable terms available either on [ti.com](https://www.ti.com) or provided in conjunction with such TI products. TI's provision of these resources does not expand or otherwise alter TI's applicable warranties or warranty disclaimers for TI products.

Mailing Address: Texas Instruments, Post Office Box 655303, Dallas, Texas 75265  
Copyright © 2021, Texas Instruments Incorporated