

Device Features

- OIP3 = 40.5 dBm @ 1900 MHz
- Gain = 19.0 dB @ 1900 MHz
- Output P1 dB = 22.7 dBm @ 1900 MHz
- Patented Over Voltage Protection Circuit
- RoHS2-compliant SOT-89 SMT package



Product Description

BeRex's BT05VG2 is a high performance and a high dynamic range amplifier in a low cost surface mount package(SOT-89) with a RoHS2-compliant, that incorporates reliable heterojunction-bipolar-transistor (HBT) devices fabricated with InGaP GaAs technology. This device is designed for use where high linearity is required and features high OIP3 and P1 with low consumption current(85mA) and requires a few external matching components such as a DC blocking capacitors on the In/Output pin, a bypass capacitor and a RF choke for the out port.

All devices are 100% RF/DC tested.

Applications

- Base station Infrastructure/RFID
- Commercial/Industrial/Military wireless system
- Wireless LAN

Application Circuits

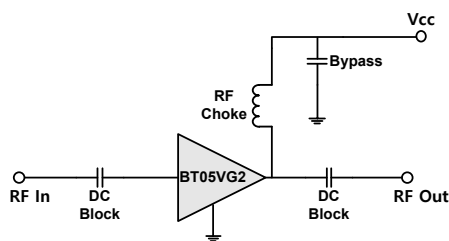

*External matching circuit: refer to the page 5 to 11.

Electrical Specifications

Device performance _ measured on a BeRex evaluation board at 25°C, Vd=5V, 50 Ω system.

Parameter	Conditions	Min	Typ	Max	Unit
Operational Frequency Range		1500		4000	MHz
Test Frequency			1900		MHz
Gain		17.5	19.0		dB
Input Return Loss			-18.5		dB
Output Return Loss			-14.9		dB
Output IP3	11 dBm / tone , Δf=1 MHz	37.5	40.5		dBm
Output P1dB		21.7	22.7		dBm
Noise Figure			3.9		dB

Recommended Operating Conditions

Parameter	Min	Typ	Max	Unit
Bandwidth	1500		4000	MHz
I _C @ (V _C = 5V)	71	88	105	mA
V _C	4.75	5.0	5.25	V
R _{TH}		50		°C/W
Operating Case Temperature	-40		+85	°C

Electrical specifications are measured at specified test conditions.

Specifications are not guaranteed over all recommended operating conditions.

Absolute Maximum Ratings

Parameter	Rating	Unit
Storage Temperature	-55 to +155	°C
Junction Temperature	+175	°C
Supply Voltage	+6.0	V
Supply Current	180	mA
Input RF Power	23	dBm

Operation of this device above any of these parameters may result in permanent damage.

Typical Performance (Vc=5V, Ic=88mA, T=25°C)

Parameter	Frequency				Unit
	1900	2100	2450	3500	MHz
Gain	19.0	18.0	16.5	13.7	dB
S11	-18.5	-15.6	-26.1	-22.0	dB
S22	-14.9	-19.1	-19.4	-20.0	dB
OIP3	40.5	38.0	38.0	39.0	dBm
P1dB	22.7	22.0	23.2	23.5	dBm
Noise Figure	3.9	4.0	4.2	4.4	dB

V-I Characteristics

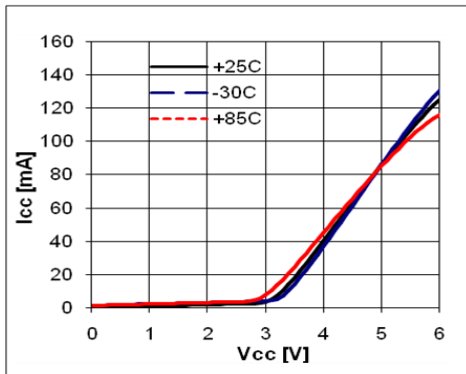

BeRex SOT89 Evaluation Board

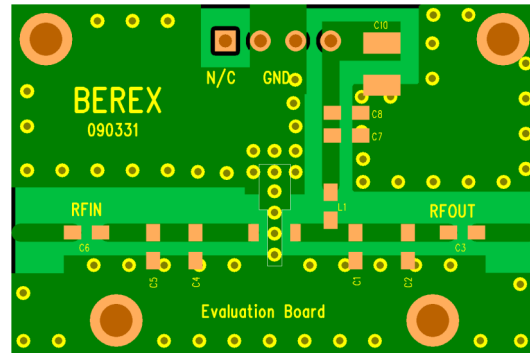

*Dielectric constant _ 4.2 *RF pattern width 52mil *31mil thick FR4 PCB

ACLR

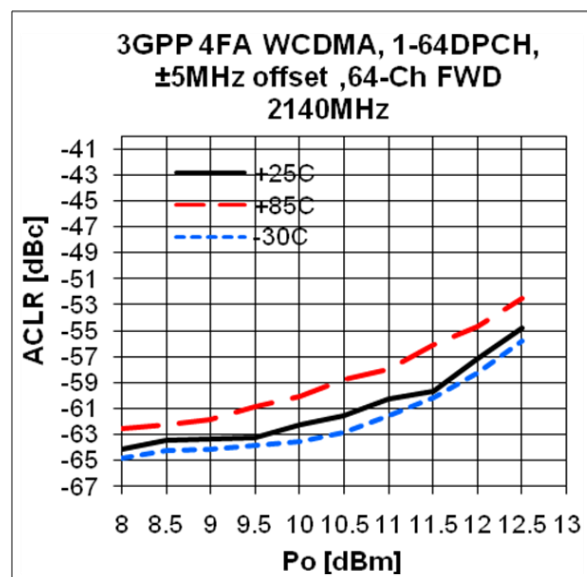

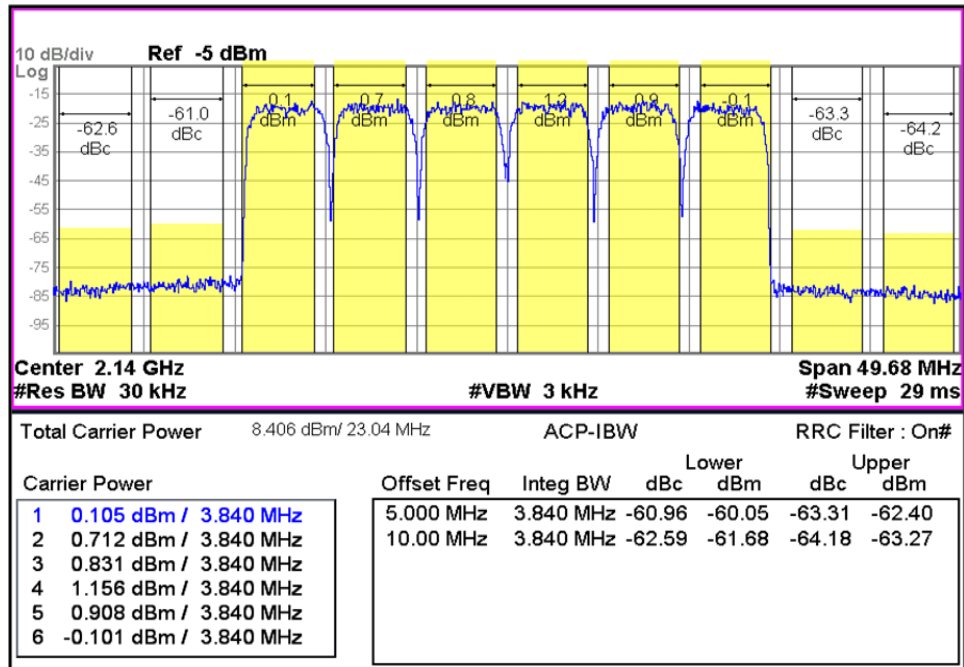
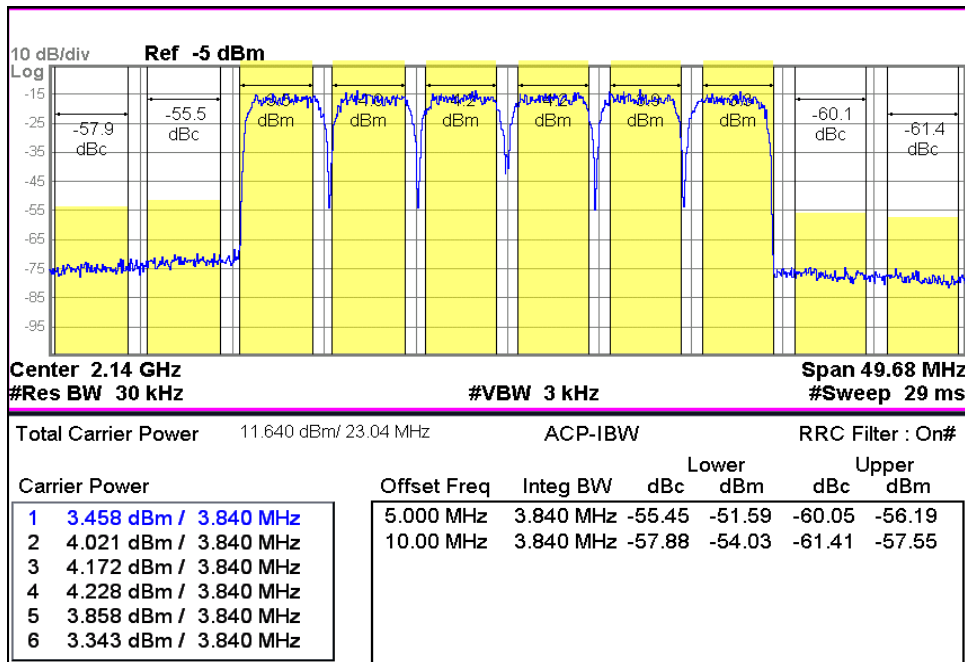
WCDMA 6FA 2140 -60dBc

WCDMA 6FA 2140 -55dBc

Typical Device Data

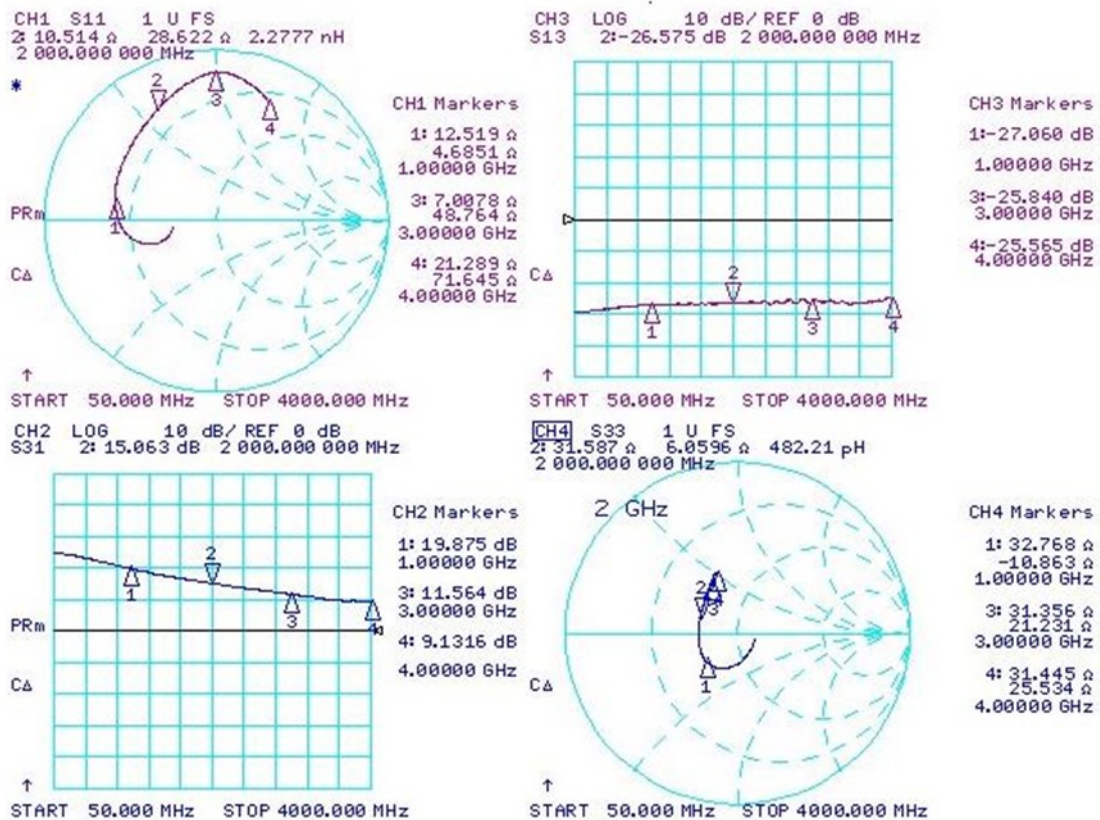
S-parameters (Vc=5V, Ic=88mA, T=25°C)



S-Parameter

(Vdevice = 5.0V, Icc = 88mA, T = 25 °C, calibrated to device leads)

Freq [MHz]	S11	S11	S21	S21	S12	S12	S22	S22
	[Mag]	[Ang]	[Mag]	[Ang]	[Mag]	[Ang]	[Mag]	[Ang]
100	0.270	-166.495	17.095	169.234	0.034	2.969	0.112	-36.553
500	0.484	-165.550	13.796	134.745	0.039	9.708	0.209	-115.545
1000	0.603	169.297	9.839	107.471	0.045	8.523	0.243	-138.751
1500	0.649	142.996	7.265	89.329	0.046	6.978	0.224	-166.419
2000	0.727	119.846	5.645	75.285	0.047	7.094	0.232	159.675
2500	0.812	103.333	4.578	65.518	0.046	7.622	0.276	133.104
3000	0.860	91.901	3.760	57.542	0.050	4.871	0.326	118.486
3500	0.845	82.120	3.142	48.480	0.046	4.636	0.365	112.242
4000	0.768	68.638	2.817	40.568	0.054	0.845	0.369	110.182

Application Circuit: 1900 MHz

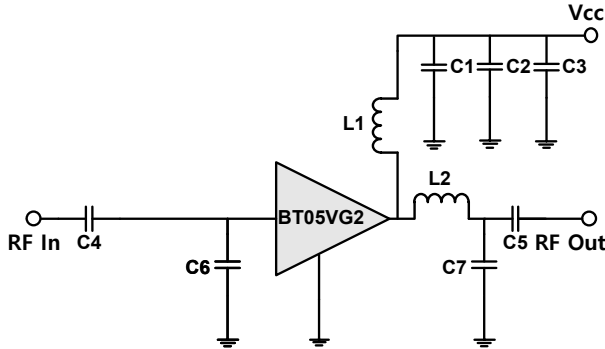
Schematic Diagram	BOM	Tolerance	
	C1	100pF	± 5%
	C2	1000pF	± 5%
	C3	10uF	± 20%
	C4	56pF	± 5%
	C5	56pF	± 5%
	C6	2.7pF	± 5%
	C7	1.8pF	± 5%
	L1	39nH	±5%
L2	1.5nH	±5%	

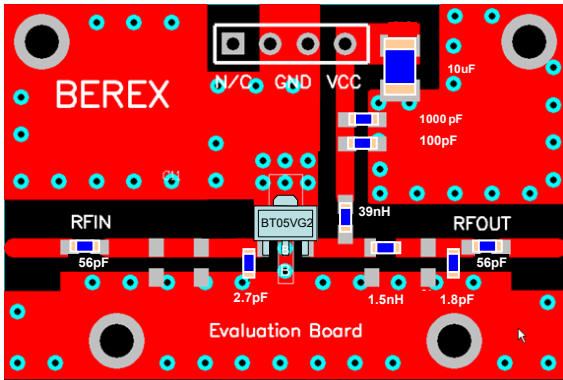

Note:

1. PCB: 31mil thick FR4.
2. Distance between the center of the shunt cap(C6) and the input pin of BT05VG2 _ **0.8mm.**
3. Distance between the center of the series inductor(L2) and the output pin of BT05VG2 _ **3.5mm.**
4. Distance between the center of the shunt cap(C7) and the output pin of BT05VG2 _ **9.0mm.**

Typical Performance (Vc=5V, Ic=88mA, T=25°C)

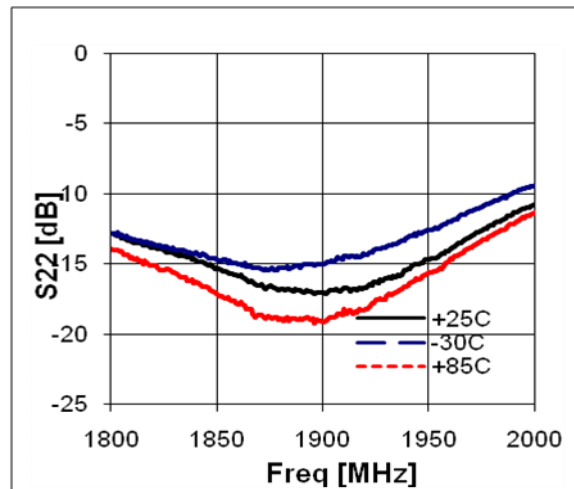
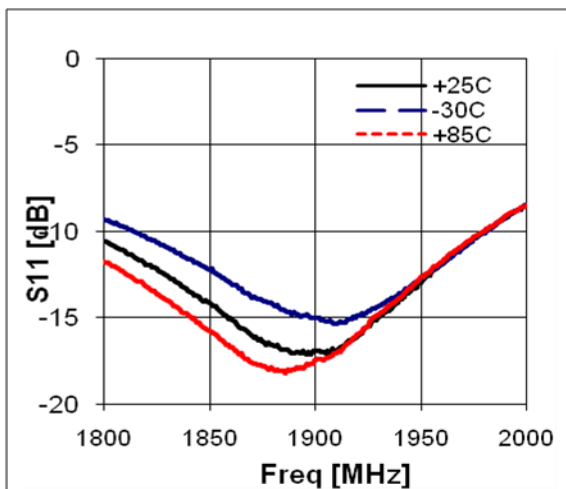

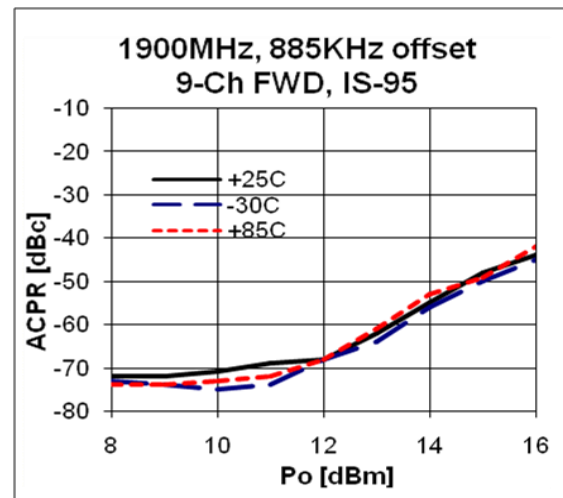
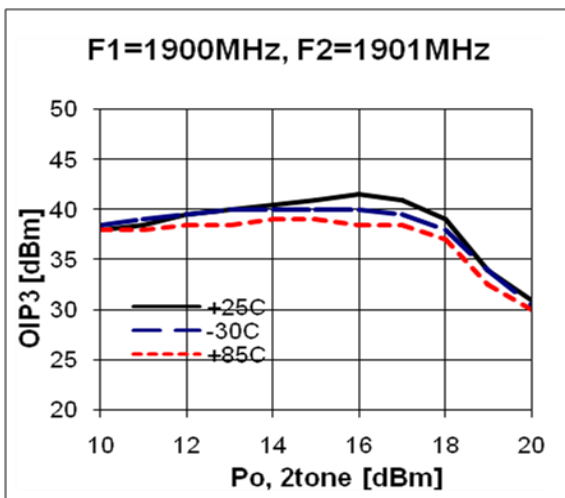
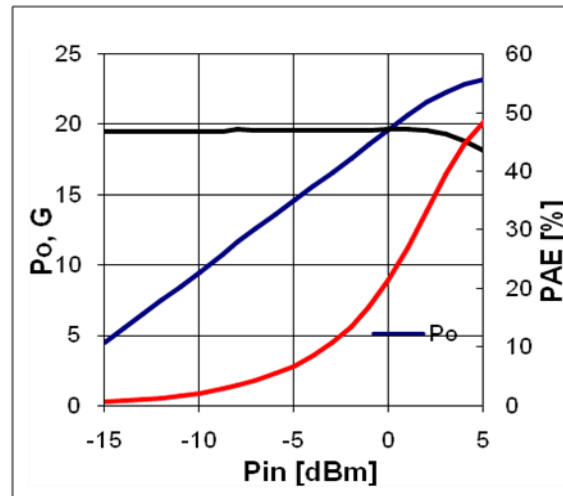
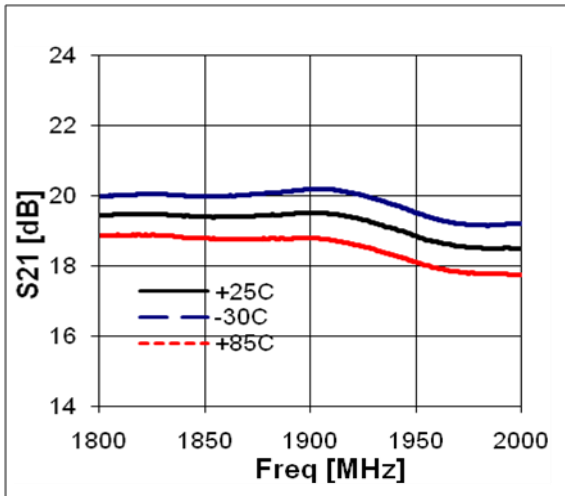

Application Circuit: 2100 MHz

Schematic Diagram	BOM	Tolerance	
	C1	100pF	± 5%
	C2	1000pF	± 5%
	C3	10uF	± 20%
	C4	56pF	± 5%
	C5	56pF	± 5%
	C6	2.2pF	± 5%
	C7	1.5pF	± 5%
	L1	47nH	±5%
	L2	1nH	±5%

Note:

1. PCB: 31mil thick FR4.
2. Distance between the center of the shunt cap(C6) and the input pin of BT05VG2 _ **0.7mm.**
3. Distance between the center of the series inductor (L2) and the output pin of BT05VG2 _ **3.5mm.**
4. Distance between the center of the shunt cap(C7) and the output pin of BT05VG2 _ **9.5mm.**

Typical Performance (Vc=5V, Ic=88mA, T=25°C)

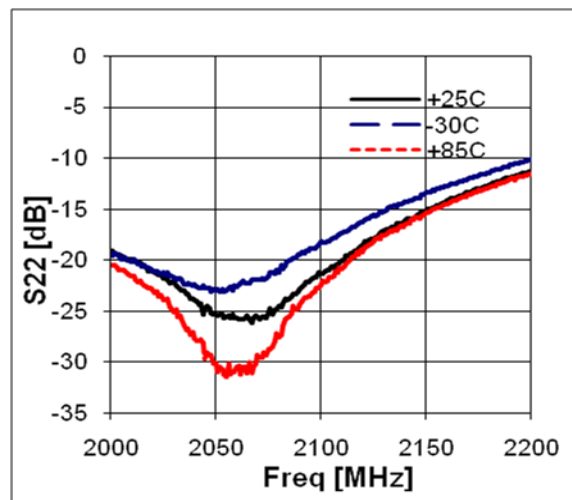
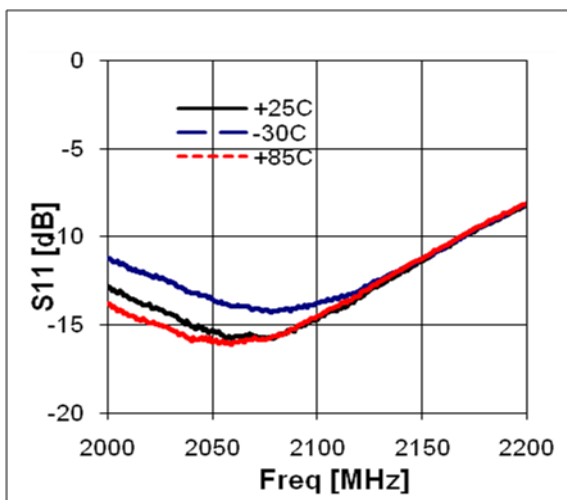

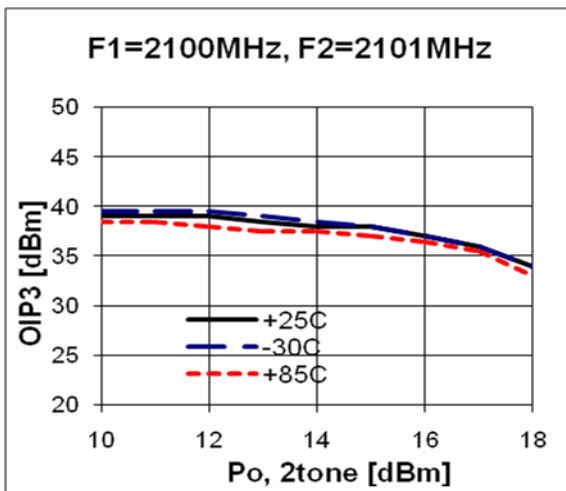
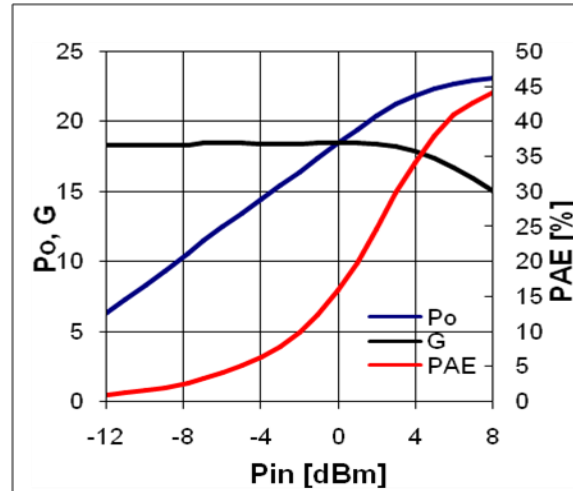
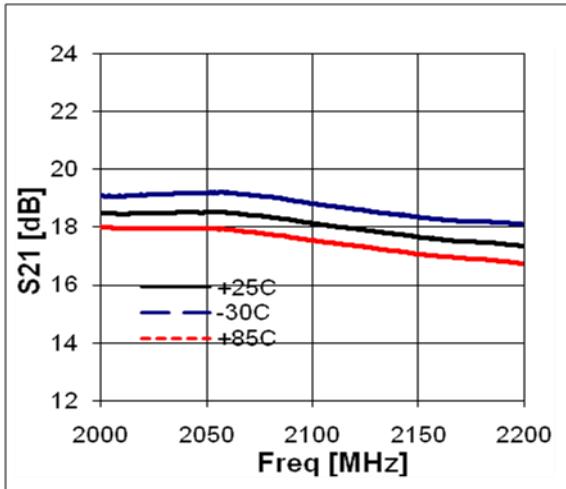

Application Circuit: 2450MHz

Schematic Diagram	BOM	Tolerance	
	C1	100pF	± 5%
	C2	1000pF	± 5%
	C3	10uF	± 20%
	C4	100pF	± 5%
	C5	1pF	± 5%
	C6	1.5pF	± 5%
	C7	0.5pF	± 5%
	L1	39nH	±5%
	L2	2.7nH	±5%
L3	1nH	±5%	

Note: 1. PCB: 31mil thick FR4.

- Distance between the center of the series inductor (L2) and the input pin of BT05VG2 _ **2.5mm.**
- Distance between the center of the shunt cap(C6) and the input pin of BT05VG2 _ **0.5mm.**
- Distance between the center of the series inductor (L3) and the output pin of BT05VG2 _ **3.5mm.**
- Distance between the center of the shunt cap(C7) and the output pin of BT05VG2 _ **5.5mm.**

Typical Performance (Vc=5V, Ic=88mA, T=25°C)

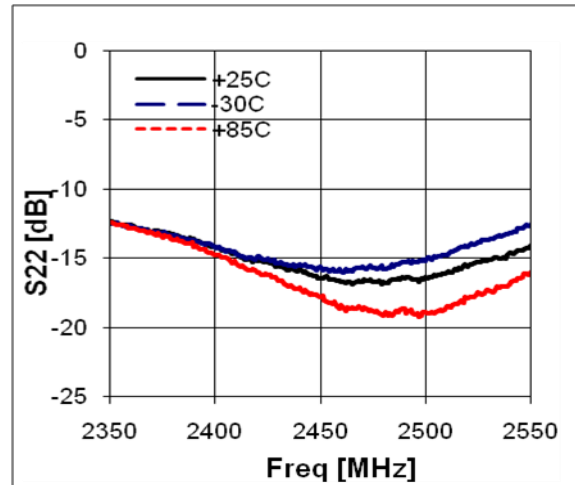
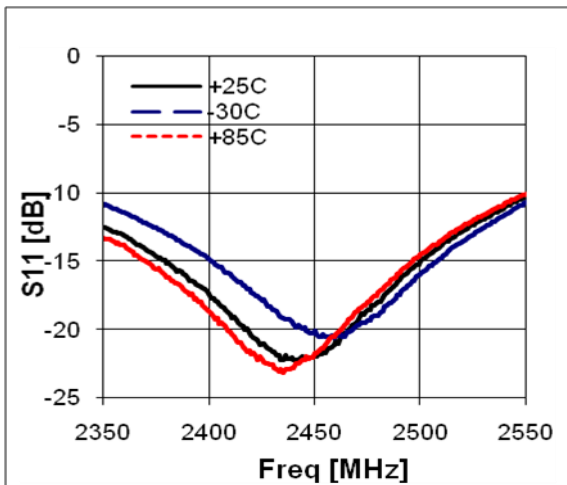

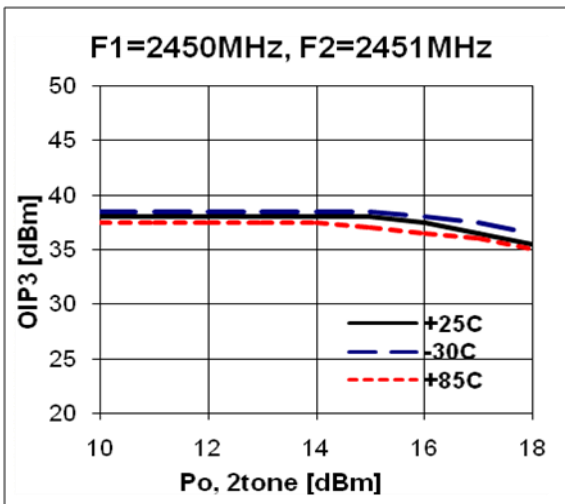
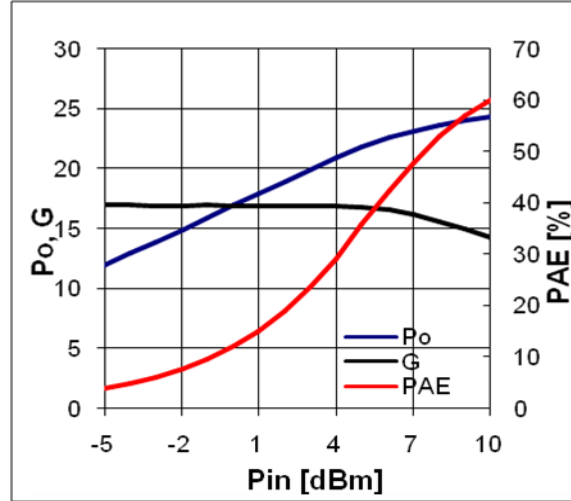
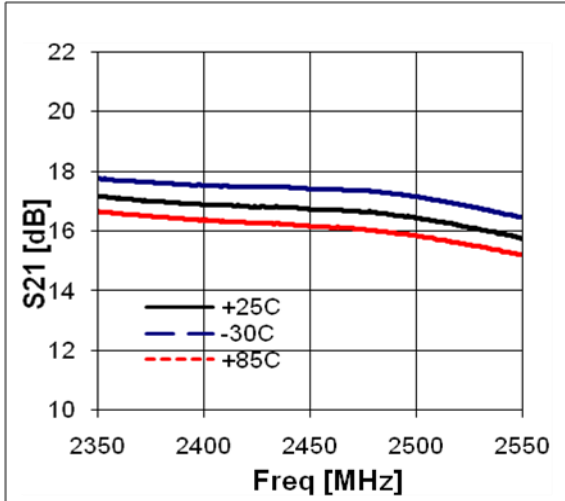

Application Circuit: 3500MHz

Schematic Diagram	BOM	Tolerance	
	C1	100pF	± 5%
	C2	1000pF	± 5%
	C3	10uF	± 20%
	C4	22pF	± 5%
	C5	22pF	± 5%
	C6	0.5pF	± 5%
	C7	0.75pF	±5%
	C8	0.5pF	±5%
L1	33nH	±5%	

Note:

1. PCB: 31mil thick FR4.
2. Distance between the center of the series cap(C6) and the input pin of BT05VG2 _ **2.5mm.**
3. Distance between the center of the shunt cap(C7) and the input pin of BT05VG2 _ **7.1mm.**
4. Distance between the center of the shunt cap(C8) and the output pin of BT05VG2 _ **7.7mm.**

Typical Performance (Vc=5V, Ic=88mA, T=25°C)

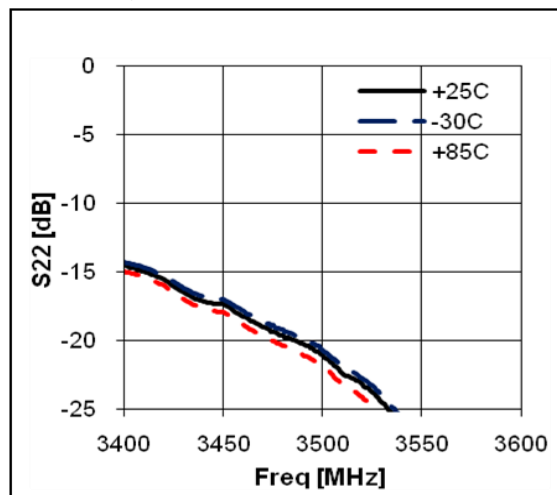
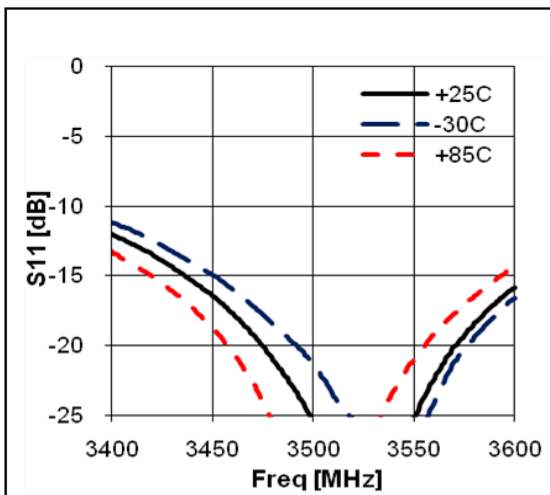

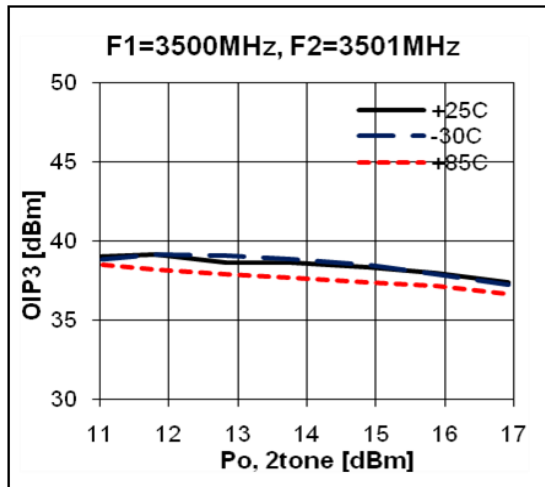
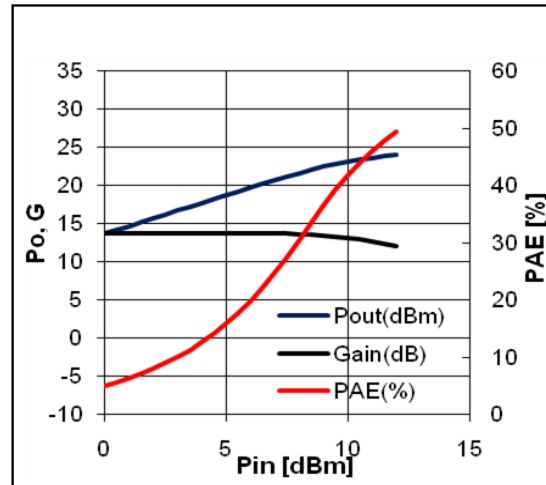
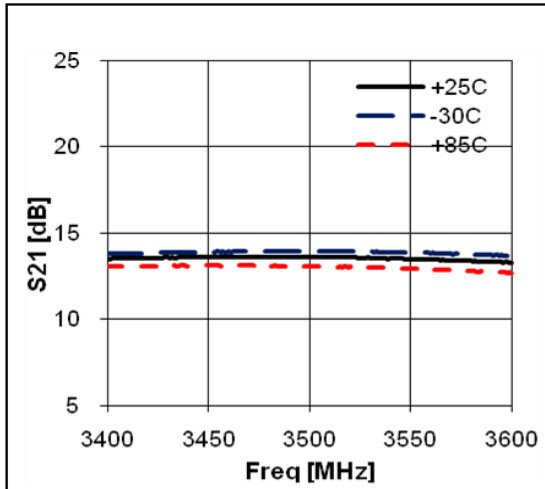

Package Outline Dimension

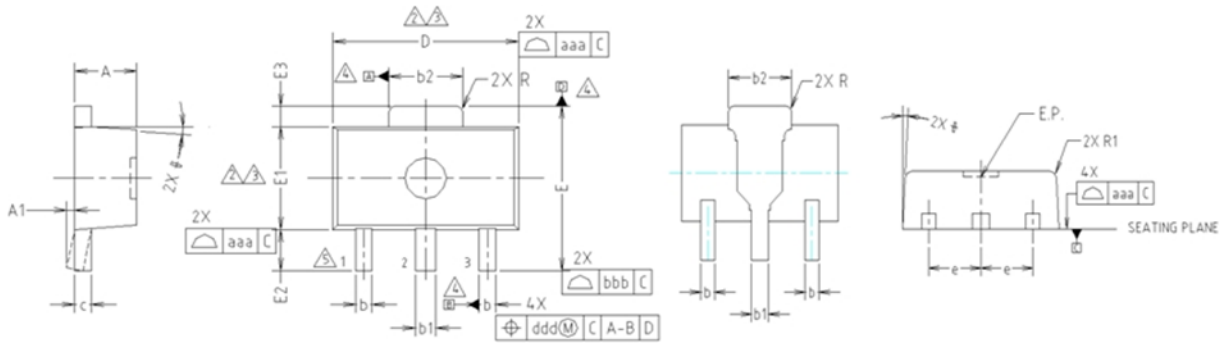

- NOTE:**
1. DIMENSIONS IN MILLIMETERS.
- ⚠ DIMENSION D DOES NOT INCLUDE MOLD FLASH, PROTRUSIONS OR GATE BURRS. MOLD FLASH, PROTRUSIONS OR GATE BURRS SHALL NOT EXCEED 0.5mm PER END. DIMENSION E1 DOES NOT INCLUDE INTERLEAD FLASH OR PROTRUSION. INTERLEAD FLASH OR PROTRUSION SHALL NOT EXCEED 0.5mm PER SIDE.
 - ⚠ DIMENSIONS D AND E1 ARE DETERMINED AT THE OUTMOST EXTREMES OF THE PLASTIC BODY EXCLUSIVE OF MOLD FLASH, TIE BAR BURRS, GATE BURRS AND INTERLEAD FLASH, BUT INCLUDING ANY MISMATCH BETWEEN THE TOP AND BOTTOM OF THE PLASTIC BODY.
 - ⚠ DATUMS A, B AND D TO BE DETERMINED 0.18mm FROM THE LEAD TIP.
 - ⚠ TERMINAL NUMBERS ARE SHOWN FOR REFERENCE ONLY.

SYMBOL	MILLIMETERS			NOTE
	MINIMUM	NOMINAL	MAXIMUM	
A	1.40	1.50	1.60	
A1	0.00	—	0.10	
b	0.38	0.42	0.48	
b1	0.48	0.52	0.58	
b2	1.79	1.82	1.87	
c	0.40	0.42	0.46	
D	4.40	4.50	4.70	2,3
E	3.70	4.00	4.30	
E1	2.40	2.50	2.70	2,3
E2	0.80	1.00	1.20	
E3	0.40	0.50	0.60	
e	1.50 TYP.			
φ	4° TYP.			
R	0.15 TYP.			
R1	—	—	0.20	
SYMBOL	TOLERANCES OF FORM AND POSITION		NOTE	
aaa	0.15			
bbb	0.20			
ccc	0.10			
ddd	0.10			

Suggested PCB Land Pattern and PAD Layout

PCB Land Pattern

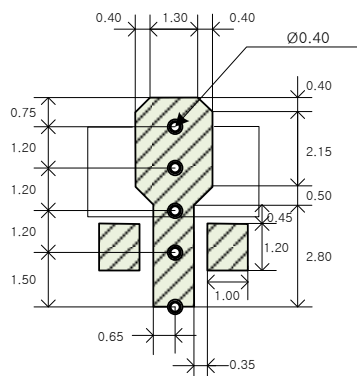

Note : All dimension are in millimeters

PCB lay out _ on BeRex website

PCB Mounting

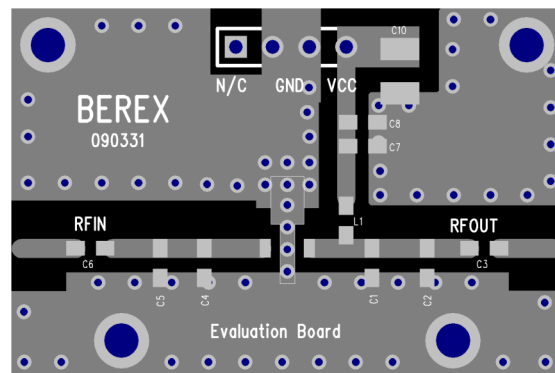

Package Marking

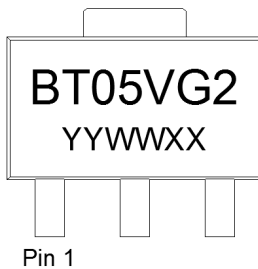

YY = Year, WW = Working Week,
XX = Wafer No.

Tape & Reel

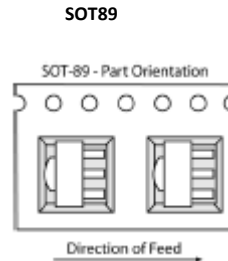

Packaging information:

Tape Width (mm): 12
Reel Size (inches): 7
Device Cavity Pitch (mm): 8
Devices Per Reel: 1000

Lead plating finish

100% Tin Matte finish

(All BeRex products undergoes a 1 hour, 150 degree C, Anneal bake to eliminate thin whisker growth concerns.)

MSL / ESD Rating

ESD Rating:	Class 1B
Value:	Passes <1000V
Test:	Human Body Model (HBM)
Standard:	JEDEC Standard JESD22-A114
MSL Rating:	Level 1 at +260°C convection reflow
Standard:	JEDEC Standard J-STD-020



Proper ESD procedures should be followed when handling this device.

RoHS Compliance

This part is compliant with Restrictions on the Use of Certain Hazardous Substances in Electrical and Electronic Equipment (RoHS) Directive 2011/65/EU as amended by Directive 2015/863/EU.

This product also is compliant with a concentration of the Substances of Very High Concern (SVHC) candidate list which are contained in a quantity of less than 0.1%(w/w) in each components of a product and/or its packaging placed on the European Community market by the BeRex and Suppliers.

NATO CAGE code:

2	N	9	6	F
---	---	---	---	---