

2.5 MHz, Fixed-Output, Synchronous TinyBoost[®] Regulator

FAN48618

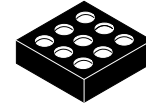

WLCSP9 1.215x1.215x0.581
CASE 567QW

The FAN48618 is a low-power boost regulator designed to provide a minimum voltage regulated rail from a standard single-cell Li-Ion battery and advanced battery chemistries. Even below the minimum system battery voltage, the device maintains output voltage regulation. The combination of built-in power transistors, synchronous rectification, and low supply current suit the FAN48618 for battery-powered applications.

The FAN48618 is available in a 9-bump, 0.4 mm pitch, Wafer-Level Chip-Scale Package (WLCSP).

Features

- Input Voltage Range: 2.7 V to 4.8 V
- Output Voltage: 5.25 V
- Internal Synchronous Rectification
- True Load Disconnect
- Short-Circuit Protection
- 9-Bump, 1.215 mm x 1.215 mm, 0.4 mm Pitch, WLCSP
- Three External Components: 2012 0.47 μ H Inductor, 0402 4.7 μ F Input Capacitor, 0603 22 μ F Output Capacitor

Applications

- Class-D Audio Amplifier and USB OTG Supply
- Boost for Low-Voltage Li-Ion Batteries
- Smart Phones, Tablets, Portable Devices, and Wearables

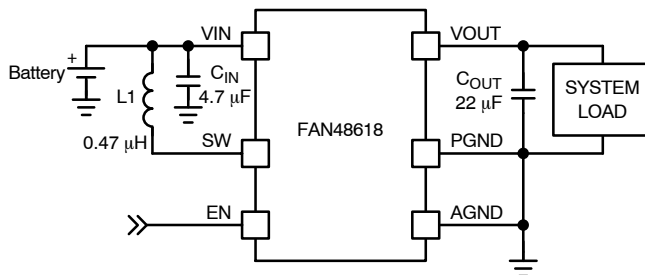
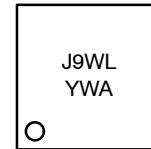

Figure 1. Typical Application

MARKING DIAGRAM



- J9 = Device Code
- WL = Wafer Lot Number
- YW = Assembly Start Week
- A = Assembly Site

ORDERING INFORMATION

See detailed ordering and shipping information on page 10 of this data sheet.

FAN48618

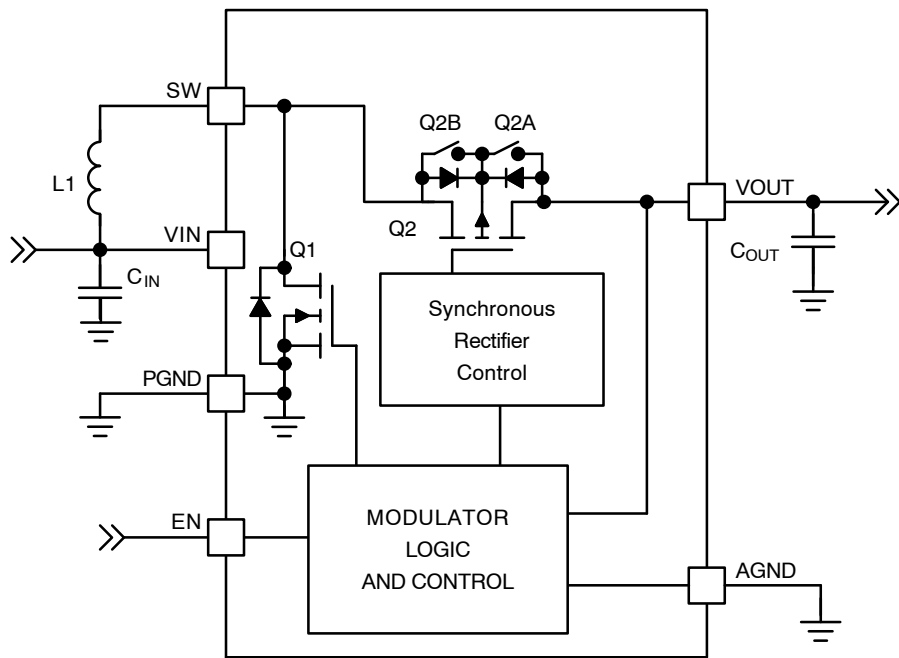

Figure 2. IC Block Diagram

RECOMMENDED COMPONENTS

Component	Description	Vendor	Parameter	Typ	Unit
L1	2012, 4.0 A, 0.8 mm Max. Height	CIGT201208EMR47SNE SEMCO	L	0.47	μH
			DCR (Series R)	37	$\text{m}\Omega$
C _{IN}	10%, 10 V, X5R, 0402	CL05A475KP5NRNC SEMCO	C	4.7	μF
C _{OUT}	20%, 10 V, X5R, 0603	CL10A226MP8NUNE SEMCO	C	22	μF

FAN48618

PIN CONFIGURATION

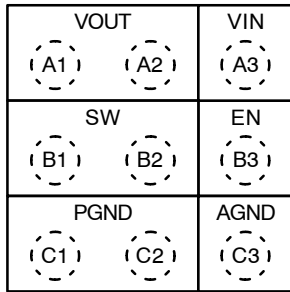

**Figure 3. Bumps Facing Down
(Top View)**

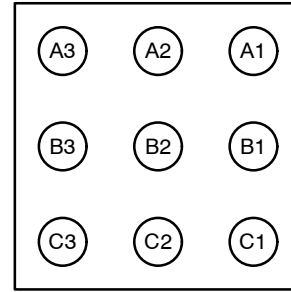

**Figure 4. Bumps Facing Up
(Bottom View)**

PIN DEFINITIONS

Pin No.	Symbol	Description
A1, A2	VOUT	<i>Output Voltage.</i> This pin is the output voltage terminal; connect directly to C_{OUT} .
A3	VIN	<i>Input Voltage.</i> Connect to the Li-Ion battery input power source and the bias supply for the gate drivers.
B1, B2	SW	<i>Switching Node.</i> Connect to inductor.
B3	EN	<i>Enable.</i> When this pin is HIGH, the circuit is enabled. It is recommended to connect and set to a logic voltage of 1.8 V after UVLO has been satisfied.
C1, C2	PGND	<i>Power Ground.</i> This is the power return for the IC. C_{OUT} capacitor should be returned with the shortest path possible to these pins.
C3	AGND	<i>Analog Ground.</i> This is the signal ground reference for the IC. All voltage levels are measured with respect to this pin. Connect to PGND at a single point.

FAN48618

ABSOLUTE MAXIMUM RATINGS

Symbol	Parameter	Min	Max	Unit
V _{IN}	Voltage on VIN Pin	-0.3	6.0	V
V _{OUT}	Voltage on VOUT Pin	-	6.0	V
V _{SW}	Voltage on SW Node	DC	6.0	V
		Transient: 10 ns, 3 MHz	8.0	
V _{CC}	Voltage on Other Pins	-0.3	6.0 (Note 1)	V
ESD	Electrostatic Discharge Protection Level	Human Body Model, ANSI/ESDA/JEDEC JS-001-2012	2	kV
		Charged Device Model per JESD22-C101	1	
T _J	Junction Temperature	-40	+150	°C
T _{STG}	Storage Temperature	-65	+150	°C
T _L	Lead Soldering Temperature (10 Seconds)	-	+260	°C

Stresses exceeding those listed in the Maximum Ratings table may damage the device. If any of these limits are exceeded, device functionality should not be assumed, damage may occur and reliability may be affected.

1. Lesser of 6.0 V or V_{IN} + 0.3 V.

RECOMMENDED OPERATING CONDITIONS

Symbol	Parameter	Min	Max	Unit
V _{IN}	Supply Voltage	2.7	4.8	V
I _{OUT}	Output Current (Note 2)	-	1200	mA
T _A	Ambient Temperature	-40	+85	°C
T _J	Junction Temperature	-40	+125	°C

Functional operation above the stresses listed in the Recommended Operating Ranges is not implied. Extended exposure to stresses beyond the Recommended Operating Ranges limits may affect device reliability.

2. Typical 1 A and 1.2 A I_{OUT} at V_{IN} = 2.7 V and 3.0 V, respectively.

THERMAL PROPERTIES

Symbol	Parameter	Typ	Unit
θ _{JA}	Junction-to-Ambient Thermal Resistance	50	°C/W

Junction-to-ambient thermal resistance is a function of application and board layout. This data is measured with four-layer 2s2p boards in accordance to JEDEC standard JESD51. Special attention must be paid not to exceed junction temperature T_{J(max)} at a given ambient temperature T_A.

FAN48618

ELECTRICAL SPECIFICATIONS (Recommended operating conditions, unless otherwise noted, circuit per Figure 1, $V_{OUT} = 5.25\text{ V}$, $V_{IN} = 2.7\text{ V}$ to 4.8 V , and $T_A = -40^\circ\text{C}$ to 85°C . Typical values are given $V_{IN} = 3.6\text{ V}$ and $T_A = 25^\circ\text{C}$.)

Symbol	Parameter	Conditions	Min	Typ	Max	Unit
--------	-----------	------------	-----	-----	-----	------

POWER SUPPLY

I_Q	V_{IN} Quiescent Current	$V_{IN} = 3.6\text{ V}$, $I_{OUT} = 0$, $EN = V_{IN}$	–	90	140	μA
		Shutdown: $EN = 0$, $V_{IN} = 3.7\text{ V}$, $V_{OUT} = 0\text{ V}$	–	2.7	10	
V_{UVLO}	Under-Voltage Lockout	V_{IN} Rising	–	2.2	2.3	V
V_{UVLO_HYS}	Under-Voltage Lockout Hysteresis		–	150	–	mV

INPUTS

V_{IH}	Enable HIGH Voltage		1.2	–	–	V
V_{IL}	Enable LOW Voltage		–	–	0.4	V
I_{PD}	Current Sink Pull-Down	EN Pin, Logic HIGH	–	100	–	nA
R_{LOW}	Low-State Active Pull-Down	EN Pin, Logic LOW	200	300	400	k Ω

OUTPUTS

V_{REG}	Output Voltage Accuracy DC (Note 3)	Referred to V_{OUT} , $V_{IN} = 3.0$ to 4.5 V	–2	–	4	%
I_{LK_OUT}	V_{IN} -to- V_{OUT} Leakage Current	$V_{OUT} = 0$, $EN = 0$, $V_{IN} = 2.7\text{ V}$	–	–	1	μA
I_{LK}	V_{OUT} -to- V_{IN} Reverse Leakage Current	$V_{OUT} = 5.25\text{ V}$, $EN = 0$, $V_{IN} = 2.7\text{ V}$	–	–	3.5	μA
V_{RIPPLE}	Output Ripple (Note 4)	0 mA to 1 A	–	25	–	mV

TIMING

f_{SW}	Switching Frequency	$V_{IN} = 3.6\text{ V}$, $V_{OUT} = 5.25\text{ V}$, $I_{LOAD} = 500\text{ mA}$	2.0	2.5	3.0	MHz
t_{SS}	Soft-Start EN HIGH to Regulation (Note 4)	$V_{IN} = 3.0\text{ V}$, $V_{OUT} = 5.25\text{ V}$, $I_{LOAD} = 0\text{ mA}$, $C_{OUT} = 22\text{ }\mu\text{F}$ (0603)	–	1000	–	μs
I_{SS}	Input Peak Current		–	90	200	mA
t_{RST}	FAULT Restart Timer (Note 4)		–	20	–	ms

POWER STAGE

$R_{DS(ON)N}$	N-Channel Boost Switch $R_{DS(ON)}$	$V_{IN} = 3.6\text{ V}$, $V_{OUT} = 5.25\text{ V}$	–	80	130	m Ω
$R_{DS(ON)P}$	P-Channel Sync. Rectifier $R_{DS(ON)}$	$V_{IN} = 3.6\text{ V}$, $V_{OUT} = 5.25\text{ V}$	–	65	115	m Ω
I_{V_LIM}	Boost Valley Current Limit	$V_{OUT} = 5.25\text{ V}$	–	2.3	–	A
$I_{V_LIM_SS}$	Boost Soft-Start Valley Current Limit	$V_{IN} < V_{OUT} < V_{OUT_TARGET}$	–	1.3	–	A
T_{150T}	Over-Temperature Protection (OTP)		–	150	–	$^\circ\text{C}$
T_{150H}	OTP Hysteresis		–	20	–	$^\circ\text{C}$

Product parametric performance is indicated in the Electrical Characteristics for the listed test conditions, unless otherwise noted. Product performance may not be indicated by the Electrical Characteristics if operated under different conditions.

- DC I_{LOAD} from 0 to 1 A. V_{OUT} measured from mid-point of output voltage ripple. Effective capacitance of $C_{OUT} \geq 5\text{ }\mu\text{F}$.
- Guaranteed by design and characterization; not tested in production.

TYPICAL CHARACTERISTICS

(Unless otherwise specified, $V_{IN} = 3.6\text{ V}$, $V_{OUT} = 5.25\text{ V}$, $T_A = 25^\circ\text{C}$, and circuit and components according to Figure 1.)

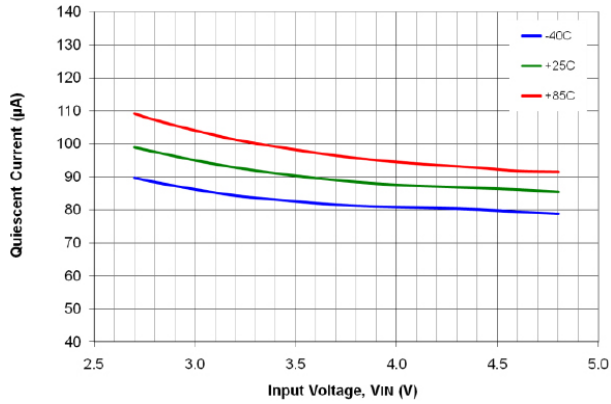

Figure 5. Quiescent Current vs. Input Voltage and Temperature

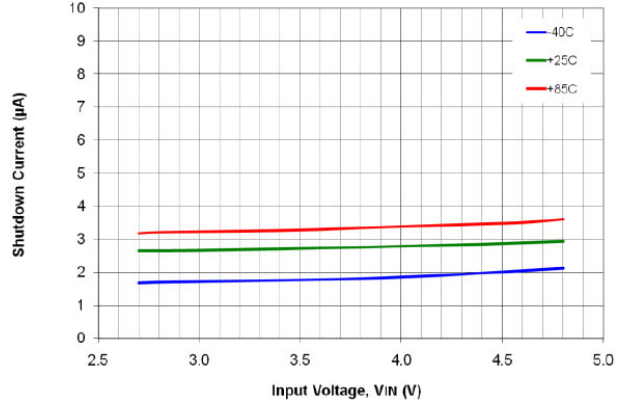

Figure 6. Shutdown Current vs. Load Current and Temperature

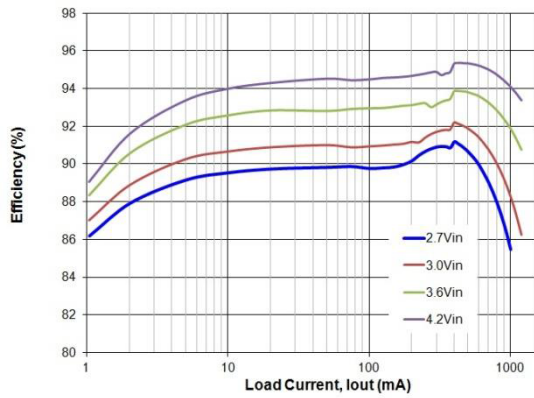

Figure 7. Efficiency vs. Load Current and Input Voltage

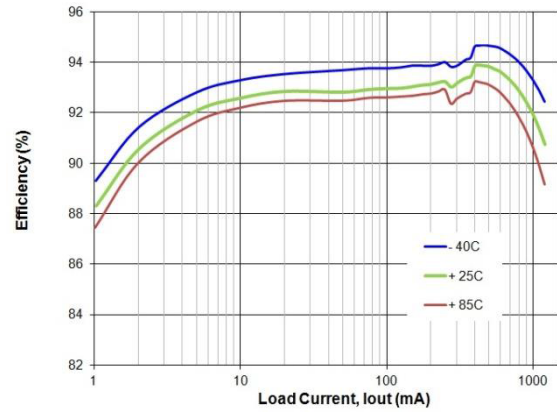

Figure 8. Efficiency vs. Load Current and Temperature

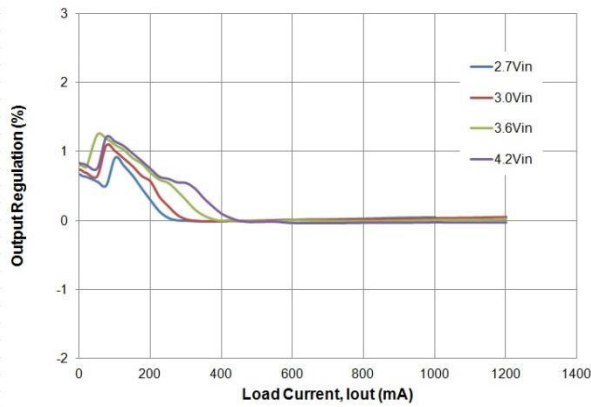

Figure 9. Output Regulation vs. Load Current and Input Voltage

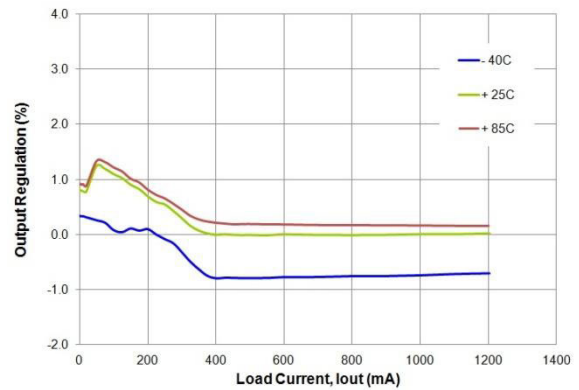

Figure 10. Output Regulation vs. Load Current and Temperature

FAN48618

TYPICAL CHARACTERISTICS (continued)

(Unless otherwise specified, $V_{IN} = 3.6\text{ V}$, $V_{OUT} = 5.25\text{ V}$, $T_A = 25^\circ\text{C}$, and circuit and components according to Figure 1.)

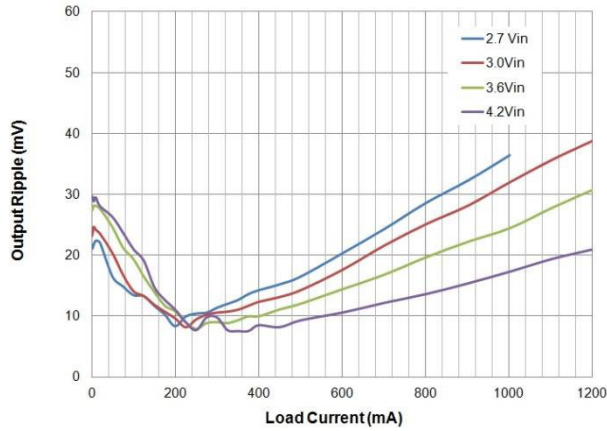

Figure 11. Output Ripple vs. Load Current and Input Voltage

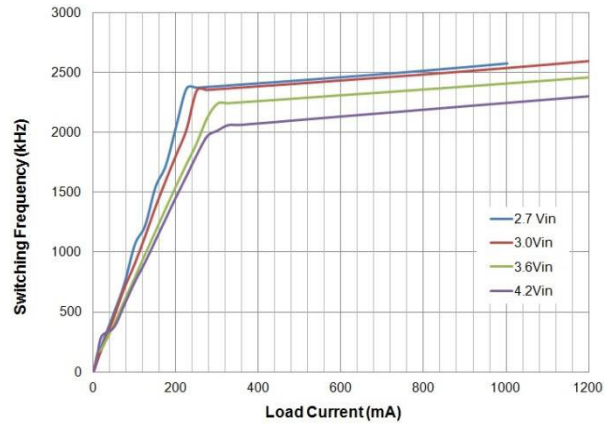

Figure 12. Switching Frequency vs. Load Current and Temperature

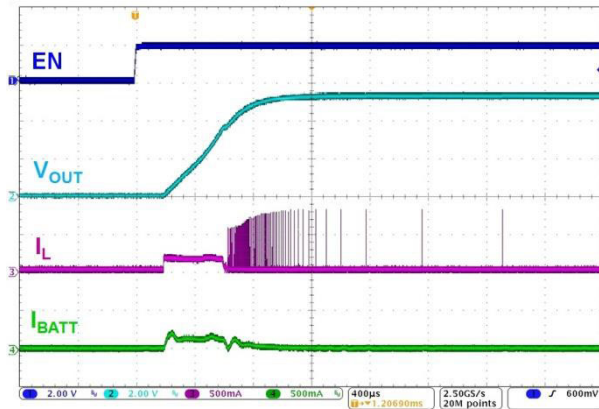

Figure 13. Startup, No Load

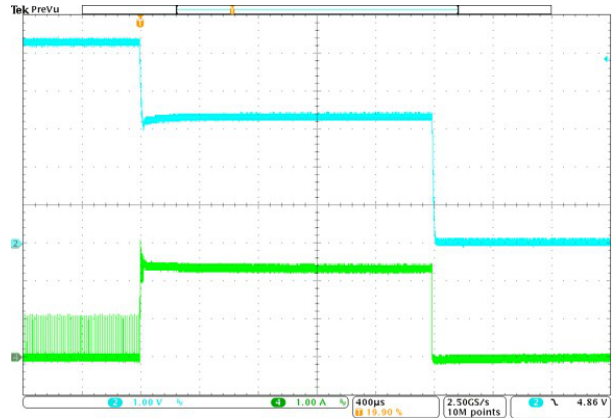

Figure 14. Overload Protection

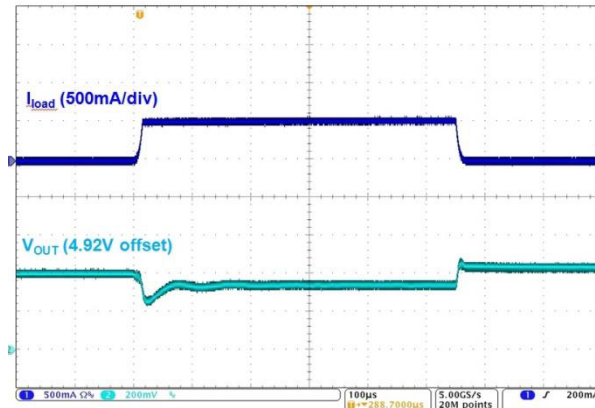

Figure 15. Load Transient, 3.8 V_{IN} , $0 \leftrightarrow 500\text{ mA}$, $8\text{ }\mu\text{s}$ Edge

FUNCTIONAL DESCRIPTION

Overview

FAN48618 is a synchronous boost regulator, typically operating at 2.5 MHz in Continuous Conduction Mode (CCM), which occurs at moderate to heavy load current and low V_{IN} voltage. Typically, 1 A and 1.2 A output currents can be obtained at input voltages ≥ 2.7 V and ≥ 3.0 V, respectively. Passive component derating must be taken into consideration, as well as, thermal properties of the regulator.

Table 1. OPERATING MODES

Mode	Description	Invoked When:
LIN	Linear Startup	$V_{IN} > V_{OUT}$
SS	Boost Soft-Start	$V_{IN} < V_{OUT} < V_{OUT(TARGET)}$
BST	Boost Mode	$V_{OUT} = V_{OUT(TARGET)}$

Table 2. BOOST STARTUP SEQUENCE

Start Mode	Entry	Exit	End Mode	Timeout (μ s)
LIN1	$V_{IN} > V_{UVLO}$, EN = 1	$V_{OUT} > V_{IN} - 300$ mV	SS	
		TIMEOUT	LIN2	512
LIN2	LIN1 Exit	$V_{OUT} > V_{IN} - 300$ mV	SS	
		TIMEOUT	FAULT	1024
SS	LIN1 or LIN2 Exit	$V_{OUT} = V_{OUT(TARGET)}$	BST	
		OVERLOAD TIMEOUT	FAULT	64

Linear Startup (LIN) Mode

When EN is HIGH and $V_{IN} > V_{UVLO}$, the regulator attempts to bring V_{OUT} within 300 mV of V_{IN} using the internal fixed current source from V_{IN} (Q2). The current is limited to the I_{SS} set point, which is typically 90 mA. The linear charging current is limited to a maximum of 200 mA to prevent any “brownout” situations where the system voltage drops too low. During LIN1 Mode, if V_{OUT} reaches $V_{IN}-300$ mV, SS Mode is initiated. Otherwise, LIN1 Mode expires after 512 μ s and LIN2 Mode is entered. In LIN2 Mode, the current source is equal to LIN1 current source I_{SS} , typically 90 mA. If V_{OUT} fails to reach $V_{IN}-300$ mV after 1024 μ s, a fault condition is declared and the device waits 20 ms (t_{RST}) to attempt an automatic restart.

Soft-Start (SS) Mode

Upon the successful completion of LIN Mode ($V_{OUT} \geq V_{IN}-300$ mV), the regulator begins switching with boost pulses current limited to 50% of nominal level. During SS Mode, if V_{OUT} fails to reach regulation during the SS ramp sequence for more than 64 μ s, a fault is declared. If a large C_{OUT} is used, the reference is automatically stepped slower to avoid excessive input current draw.

Boost Mode Regulation

The current-mode modulator achieves excellent transient response and smooth transitions between CCM and DCM operation. During CCM operation, the device maintains a switching frequency of about 2.5 MHz. In light-load operation (DCM), frequency is naturally reduced to maintain high efficiency.

Startup and Shutdown

When EN is LOW, all bias circuits are off and the regulator enters Shutdown Mode. During shutdown, current flow is prevented from V_{IN} to V_{OUT} , as well as reverse flow from V_{OUT} to V_{IN} . It is recommended to keep load current draw below 50 mA until the device successfully executes startup. The following table describes the startup sequence.

Boost (BST) Mode

This is the normal operating mode of the regulator.

Fault State

The regulator enters Fault State under any of the following conditions:

- V_{OUT} fails to achieve the voltage required to advance from LIN Mode to SS Mode.
- V_{OUT} fails to achieve the voltage required to advance from SS Mode to BST Mode.
- Boost current limit triggers for 2 ms during BST Mode.
- $V_{IN} - V_{OUT} > 300$ mV; this fault can only occur after successful completion of the soft-start sequence.
- $V_{IN} < V_{UVLO}$

Once a fault is triggered, the regulator stops switching and presents a high-impedance path between V_{IN} and V_{OUT} . After waiting 20 ms, an automatic restart is attempted.

Over-Temperature Protection

The regulator shuts down if the die temperature exceeds 150°C. Restart occurs when the IC has cooled by approximately 20°C.

APPLICATION INFORMATION

Output Capacitance (C_{OUT})

The effective capacitance (C_{EFF} (Note 5)) of small, high-value ceramic capacitors decreases as their bias voltage increases, as illustrated in the graph below:

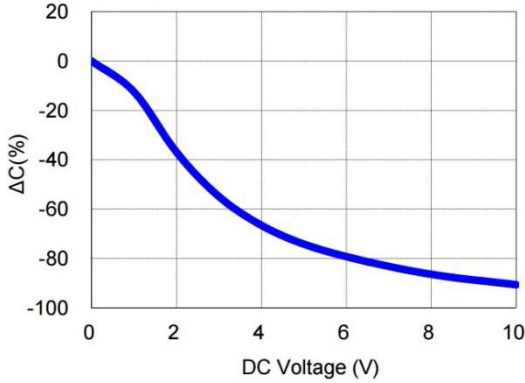

Figure 16. C_{EFF} for 22 μF, 0603, X5R, 10 V-Rated Capacitor (SEMCO CL10A226MP8NUNE)

FAN48618 is guaranteed for stable operation with the typical value of C_{EFF} outlined in the table below.

Table 3. TYPICAL C_{EFF} REQUIRED FOR STABILITY

Operating Conditions			C _{EFF} (μF)
V _{OUT} (V)	V _{IN} (V)	I _{LOAD} (mA)	
5.25	2.7 to 4.5	0 to 1000	5

5. C_{EFF} varies by manufacturer, capacitor material, and case size.

Inductor Selection

Recommended nominal inductance value is 0.47 μH.

The FAN48618 employs valley-current limiting, so peak inductor current can reach 3.6 A for a short duration during overload conditions. Saturation causes the inductor current ripple to increase under high loading, as only the valley of the inductor current ripple is controlled.

Startup

Input current limiting is active during soft-start, which limits the current available to charge C_{OUT} and any additional capacitance on the V_{OUT} line. If the output fails

to achieve regulation within the limits described in the Soft-Start section above, a fault occurs, causing the circuit to shut down. It waits about 20 ms before attempting a restart. If the total combined output capacitance is very high, the circuit may not start on the first attempt, but eventually achieves regulation if no load is present. If a high current load and high capacitance are both present during soft-start, the circuit may fail to achieve regulation and continually attempt soft-start, only to have the output capacitance discharged by the load when in Fault State.

Output Voltage Ripple

Output voltage ripple is inversely proportional to C_{OUT}. During t_{ON}, when the boost switch is on, all load current is supplied by C_{OUT}.

$$V_{\text{RIPPLE(P-P)}} = t_{\text{ON}} \cdot \frac{I_{\text{LOAD}}}{C_{\text{OUT}}} \tag{eq. 1}$$

and

$$t_{\text{ON}} = t_{\text{SW}} \cdot D = t_{\text{SW}} \cdot \left(1 - \frac{V_{\text{IN}}}{V_{\text{OUT}}}\right) \tag{eq. 2}$$

therefore:

$$V_{\text{RIPPLE(P-P)}} = t_{\text{SW}} \cdot \left(1 - \frac{V_{\text{IN}}}{V_{\text{OUT}}}\right) \cdot \frac{I_{\text{LOAD}}}{C_{\text{OUT}}} \tag{eq. 3}$$

where:

$$t_{\text{SW}} = \frac{1}{f_{\text{SW}}} \tag{eq. 4}$$

The maximum V_{RIPPLE} occurs when V_{IN} is minimum and I_{LOAD} is maximum. For better ripple performance, more output capacitance can be added.

Layout Recommendations

The layout recommendations below highlight various topcopper pours by using different colors. To minimize spikes at V_{OUT}, C_{OUT} must be placed as close as possible to PGND and V_{OUT}, as shown below. For best thermal performance, maximize the pour area for all planes other than SW. The ground pour, especially, should fill all available PCB surface area and be tied to internal layers with a cluster of thermal vias.

FAN48618

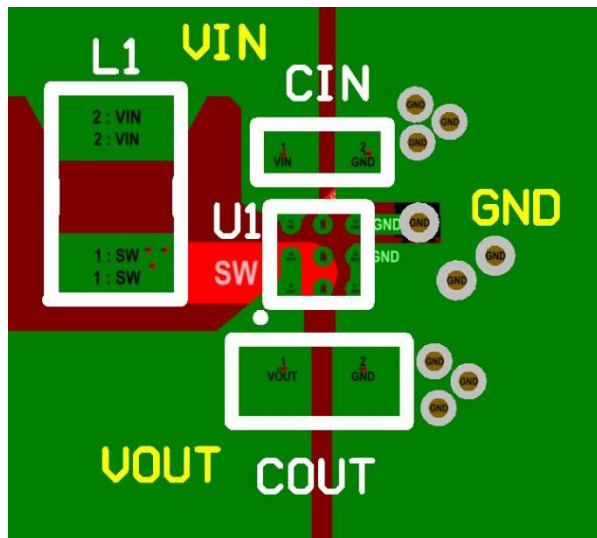

Figure 17. Layout Recommendation

ORDERING INFORMATION

Part Number	Device Marking	V _{OUT}	Operating Temperature Range	Package	Shipping [†]
FAN48618BUC53X	J9	5.25 V	-40°C to 85°C	9-Bump, 0.4 mm Pitch, Wafer-Level Chip-Scale Package (WLCSP)	3000 / Tape & Reel

[†]For information on tape and reel specifications, including part orientation and tape sizes, please refer to our Tape and Reel Packaging Specifications Brochure, BRD8011/D.

TINYBOOST is registered trademark of Semiconductor Components Industries, LLC dba "onsemi" or its affiliates and/or subsidiaries in the United States and/or other countries.

FAN48618

PACKAGE DIMENSIONS

WLCSP9 1.215x1.215x0.581
CASE 567QW
ISSUE O

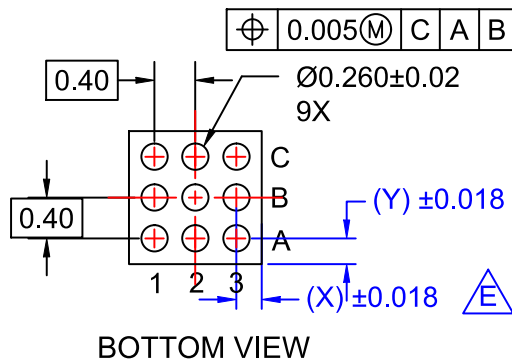
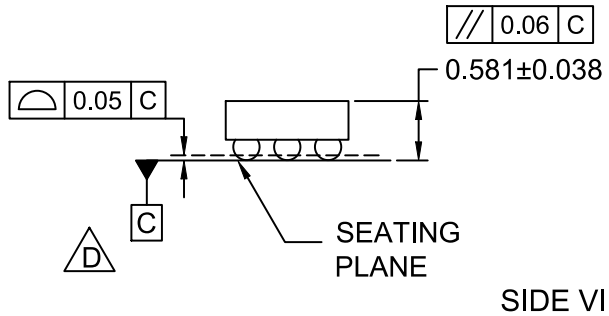
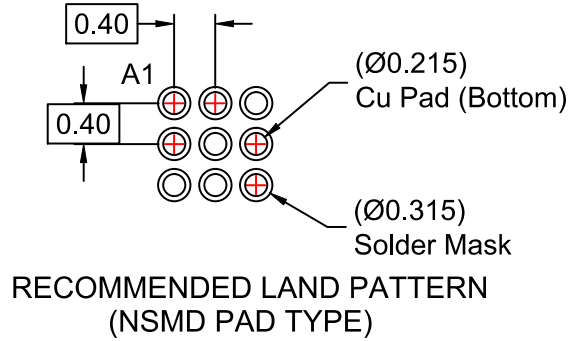
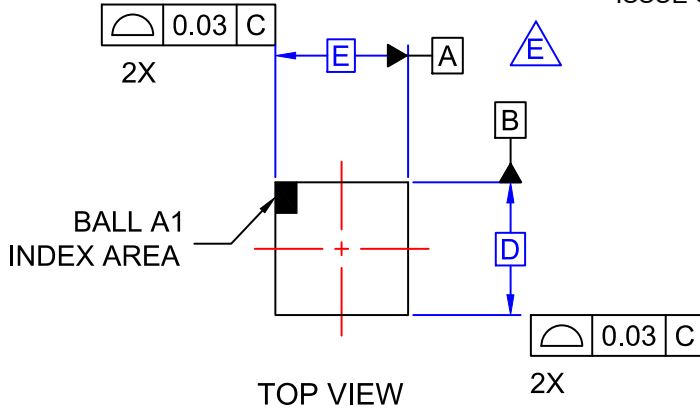

NOTES

- A. NO JEDEC REGISTRATION APPLIES.
- B. DIMENSIONS ARE IN MILLIMETERS.
- C. DIMENSIONS AND TOLERANCE PER ASME Y14.5M, 2009.
- D. DATUM C IS DEFINED BY THE SPHERICAL CROWNS OF THE BALLS.
- E. FOR DIMENSIONS D, E, X, AND Y SEE PRODUCT DATASHEET.

onsemi, Onsemi, and other names, marks, and brands are registered and/or common law trademarks of Semiconductor Components Industries, LLC dba "onsemi" or its affiliates and/or subsidiaries in the United States and/or other countries. onsemi owns the rights to a number of patents, trademarks, copyrights, trade secrets, and other intellectual property. A listing of onsemi's product/patent coverage may be accessed at www.onsemi.com/site/pdf/Patent-Marking.pdf. onsemi reserves the right to make changes at any time to any products or information herein, without notice. The information herein is provided "as-is" and onsemi makes no warranty, representation or guarantee regarding the accuracy of the information, product features, availability, functionality, or suitability of its products for any particular purpose, nor does onsemi assume any liability arising out of the application or use of any product or circuit, and specifically disclaims any and all liability, including without limitation special, consequential or incidental damages. Buyer is responsible for its products and applications using onsemi products, including compliance with all laws, regulations and safety requirements or standards, regardless of any support or applications information provided by onsemi. "Typical" parameters which may be provided in onsemi data sheets and/or specifications can and do vary in different applications and actual performance may vary over time. All operating parameters, including "Typicals" must be validated for each customer application by customer's technical experts. onsemi does not convey any license under any of its intellectual property rights nor the rights of others. onsemi products are not designed, intended, or authorized for use as a critical component in life support systems or any FDA Class 3 medical devices or medical devices with a same or similar classification in a foreign jurisdiction or any devices intended for implantation in the human body. Should Buyer purchase or use onsemi products for any such unintended or unauthorized application, Buyer shall indemnify and hold onsemi and its officers, employees, subsidiaries, affiliates, and distributors harmless against all claims, costs, damages, and expenses, and reasonable attorney fees arising out of, directly or indirectly, any claim of personal injury or death associated with such unintended or unauthorized use, even if such claim alleges that onsemi was negligent regarding the design or manufacture of the part. onsemi is an Equal Opportunity/Affirmative Action Employer. This literature is subject to all applicable copyright laws and is not for resale in any manner.

PUBLICATION ORDERING INFORMATION

LITERATURE FULFILLMENT:
Email Requests to: orderlit@onsemi.com

onsemi Website: www.onsemi.com

TECHNICAL SUPPORT
North American Technical Support:
Voice Mail: 1 800-282-9855 Toll Free USA/Canada
Phone: 011 421 33 790 2910

Europe, Middle East and Africa Technical Support:
Phone: 00421 33 790 2910
For additional information, please contact your local Sales Representative