

# ADP3290

## 8-Bit, Programmable 2- to 4-Phase Synchronous Buck Controller

The ADP3290 is a highly efficient, multi-phase, synchronous buck switching regulator controller optimized for converting a 12 V main supply voltage into the core supply voltage of high performance Intel processors. It uses an internal 8-bit DAC to read a Voltage Identification (VID) code directly from the processor, to set the output voltage between 0.5 V and 1.6 V.

This device uses a multi-mode control architecture to drive the logic-level PWM outputs. The switching frequency can be programmed according to VR size and efficiency. The chip can provide 2-, 3- or 4-phase operation, allowing for the construction of up to four complementary buck switching stages.

The ADP3290 also includes programmable no load offset and load line slope setting function that adjusts the output voltage as a function of the load current, optimally positioning it for a system transient. The ADP3290 also provides accurate and reliable short-circuit protection, adjustable current limit, and a delayed power-good output that accommodates On-The-Fly (OTF) output voltage changes requested by the CPU.

### Features

- Selectable 2-, 3-, or 4-Phase Operation at Up to 1 MHz Per Phase
- $\pm 7$  mV Worst-Case Differential Sensing Error
- Logic-Level PWM Outputs for Interface to External High Power Drivers
- Fast-Enhanced PWM FlexMode™ for Excellent Load Transient Performance
- TRDET to Improve Load Release
- Active Current Balancing Between All Output Phases
- Built-In Power-Good/Crowbar Blanking Supports Dynamic VID Code Changes
- Digitally Programmable 0.5 V to 1.6 V Output Supports VR11.1 Specification
- Programmable Overcurrent Protection with Programmable Latchoff Delay
- This is a Pb-Free Device

### Typical Applications

- Desktop PC Power Supplies for:
  - ◆ Next Generation Intel® Processors
  - ◆ VRM Modules



ON Semiconductor®

<http://onsemi.com>

**Package Name**  
LFCSP40  
**CASE Number**  
932AC

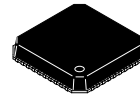

**MARKING  
DIAGRAM**

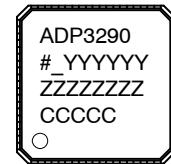

ADP3290 = Device Code  
# = Pb-Free Package  
YY = Date Code  
ZZ = Assembly Lot Number  
CC = Country of Origin

### PIN ASSIGNMENT

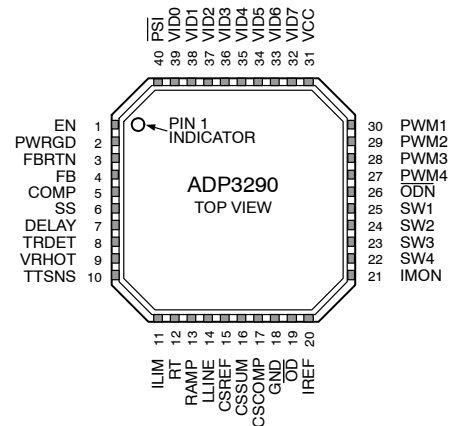

### ORDERING INFORMATION

Device	Package	Shipping†
ADP3290JCPZ-RL	LFCSP40 (Pb-Free)	2500/Tape & Reel

†For information on tape and reel specifications, including part orientation and tape sizes, please refer to our Tape and Reel Packaging Specifications Brochure, BRD8011/D.





# ADP3290

## ABSOLUTE MAXIMUM RATINGS

Parameter	Symbol	Value	Unit
Supply Voltage	$V_{CC}$	-0.3 to +6	V
FBRTN	$V_{FBRTN}$	-0.3 to +0.3	V
PWM3 to PWM4, Rampadj		-0.3 to $V_{CC} + 0.3$	V
SW1 to SW4		-5 to +25	V
SW1 to SW4 <200 ns		-10 to +25	V
All other Inputs and Outputs		-0.3 to $V_{CC} + 0.3$	V
Storage Temperature Range	$T_{stg}$	-65 to +150	°C
Operating Ambient Temperature Range	$T_A$	0 to 85	°C
Operating Junction Temperature	$T_J$	125	°C
Thermal Impedance	$\theta_{JA}$	100	°C/W
Lead Temperature Soldering (10 sec) Infrared (15 sec)		300 260	°C

Stresses exceeding Maximum Ratings may damage the device. Maximum Ratings are stress ratings only. Functional operation above the Recommended Operating Conditions is not implied. Extended exposure to stresses above the Recommended Operating Conditions may affect device reliability.

NOTE: This device is ESD sensitive. Use standard ESD precautions when handling.

# ADP3290

## PIN ASSIGNMENT

Pin No.	Mnemonic	Description
1	EN	Power Supply Enable Input. Pulling this pin to GND disables the PWM outputs and pulls the PWRGD output low.
2	PWRGD	Power-Good Output. Open-drain output that signals when the output voltage is outside of the proper operating range.
3	FBRTN	Feedback Return. VID DAC and error amplifier input for remote sensing of the output voltage.
4	FB	Feedback Input. Error amplifier reference for remote sensing of the output voltage. An external resistor between this pin and the output voltage sets the no-load offset point.
5	COMP	Error Amplifier Output and Compensation Point.
6	SS	Soft-Start Delay Setting Input. An external capacitor connected between this pin and GND sets the soft-start ramp-up time. After startup, pin used to control DVID slew-rate.
7	DELAY	Delay Timer Setting Input. An external capacitor connected between this pin and GND sets the overcurrent latching delay time, boot voltage hold time, EN delay time, and PWRGD delay time.
8	TRDET	Transient detection output. This pin is pulled low when a load release transient is detected.
9	VRHOT	VR Hot Output. Active high open-drain output that signals when the temperature of the temperature sensor connected to TTSNS exceeds the programmed VRHOT temperature threshold.
10	TTSNS	VR Hot Thermal Throttling Sense Input. An NTC thermistor between this pin and GND is used to remotely sense the temperature at the desired thermal monitoring point.
11	ILIM	Current Sense and Limit Pin. Connecting a resistor from this pin to CSCOMP sets the internal current sensing signal for current limit and IMON.
12	RT	Frequency Setting Resistor Input. An external resistor connected between this pin and GND sets the PWM oscillator frequency.
13	RAMP	PWM Ramp Slope Setting Input. An external resistor from the converter input voltage to this pin sets the slope of the internal PWM ramp.
14	LLINE	Output Load Line Programming Input. This pin can be directly connected to CSCOMP, or it can be connected to the center point of a resistor divider between CSCOMP and CSREF. Connecting LLINE to CSREF disables positioning.
15	CSREF	Current Sense Reference Voltage Input. The voltage on this pin is used as the reference for the current sense amplifier and the power-good and crowbar functions. This pin should be connected to the common point of the output inductors.
16	CSSUM	Current Sense Summing Node. External resistors from each switch node to this pin sum the inductor currents together to measure the total output current.
17	CSCOMP	Current Sense Compensation Point. A resistor and capacitor from this pin to CSSUM determines the gain of the current sense amplifier and the positioning loop response time.
18	GND	Ground. All internal biasing and the logic output signals of the device are referenced to this ground.
19	$\overline{OD}$	Output Disable Logic Output for phase 1. This pin is actively pulled low when the EN input is low or when VCC is below its UVLO threshold to signal to the Driver IC that the driver high-side and low-side outputs should go low.
20	IREF	Current Reference Input. An external resistor from this pin to ground sets the internal reference current used to generate $I_{FB}$ , $I_{DELAY}$ , $I_{SS}$ , $I_{CL}$ , and $I_{TTSNS}$ .
21	IMON	IMON Total Current Output Pin. A resistor/capacitor from this pin to FBRTN/VSS Sense sets the IMON signal.
22 to 25	SW4 to SW1	Current Balance Inputs. Inputs for measuring the current level in each phase. The SW pins of unused phases should be left open.
26	$\overline{ODN}$	Output Disable Logic output for PSI Operation. This pin is pulled low when $\overline{PSI}$ is low, otherwise it functions the same as $\overline{OD}$ .
27 to 30	PWM4 to PWM1	Logic-Level PWM Outputs. Each output is connected to the input of an external MOSFET driver such as the ADP3121. Connecting the PWM4, and/or PWM3 output to VCC causes that phase to turn off, allowing the ADP3290 to operate as a 2-, 3-, or 4-phase controller.
31	VCC	Supply Voltage for the Device. A 340 $\Omega$ resistor should be placed between the 12 V system supply and the VCC pin. The internal shunt regulator maintains VCC = 5.0 V.
32 to 39	VID7 to VID0	Voltage Identification DAC Inputs. These eight pins are pulled down to GND, providing a Logic 0 if left open. When in normal operation mode, the DAC output programs the FB regulation voltage from 0.5 V to 1.6 V.
40	$\overline{PSI}$	Power State Indicator Input. Pulling this pin low places controller in lower power state operation.

NOTE: True no connect. Printed circuit board traces are allowable.

# ADP3290

## ELECTRICAL CHARACTERISTICS ( $V_{CC} = 12\text{ V}$ , FBRTN = GND, $T_A = 0^\circ\text{C}$ to $85^\circ\text{C}$ unless otherwise noted) (Note 1)

Parameter	Symbol	Conditions	Min	Typ	Max	Unit
<b>Reference Current</b>						
Reference Bias Voltage	$V_{IREF}$			1.5		V
Reference Bias Current	$I_{IREF}$	$R_{IREF} = 100\text{ k}\Omega$	14.25	15	15.75	$\mu\text{A}$

### Error Amplifier

Output Voltage Range (Note 2)	$V_{COMP}$		0		4.4	V
Accuracy	$V_{FB}$	Relative to nominal DAC output, Referenced to FBRTN, LLINE = CSREF, Temperature Range: $0^\circ\text{C}$ to $60^\circ\text{C}$ DAC Code: 0.5 V to 0.99375 V 1.0 V to 1.39375 V 1.4 V to 1.6 V	-8.0 -7.0 -0.5		+8.0 +7.0 +0.5	mV mV %
Load Line Positioning Accuracy	$V_{FB(BOOT)}$	In startup CSREF - LLINE = 80 mV, Temperature Range: $0^\circ\text{C}$ to $60^\circ\text{C}$ , DAC = 1.000 V	1.092 -81.7	1.1 -80	1.108 -78.3	V mV
Differential Non-linearity			-1.0		+1.0	LSB
Input Bias Current	$I_{FB}$	$I_{FB} = I_{IREF}$	13.5	15	16.5	$\mu\text{A}$
FBRTN Current	$I_{FBRTN}$			125	200	$\mu\text{A}$
Output Current	$I_{COMP}$	FB forced to $V_{OUT} - 3\%$		500		$\mu\text{A}$
Gain Bandwidth Product	$GBW_{(ERR)}$	COMP = FB		20		MHz
Slew Rate		COMP = FB		25		V/ $\mu\text{s}$
LLINE Input Voltage Range	$V_{LLINE}$	Relative to CSREF	-250		+250	mV
LLINE Input Bias Current	$I_{LLINE}$	Temperature Range: $0^\circ\text{C}$ to $60^\circ\text{C}$	-7.5		+7.5	nA
BOOT Voltage Hold Time	$t_{BOOT}$	$C_{DELAY} = 10\text{ nF}$		2.0		ms

### VID Inputs

Input Low Voltage	$V_{IL(VID)}$	VID(X)			0.3	V
Input High Voltage	$V_{IH(VID)}$	VID(X)	0.8			V
Input Current	$I_{IN(VID)}$			-1.0		$\mu\text{A}$
VID Transition Delay Time (Note 3)		VID code change to FB change	400			ns
No CPU Detection Turn-Off Delay Time (Note 2)		VID code change to PWM going low	5.0			$\mu\text{s}$

### PSI Input

Input Low Voltage	$V_{IL(PSI)}$				0.3	V
Input High Voltage	$V_{IH(PSI)}$		0.8			V
Input Current	$I_{IN(PSI)}$	PSI = HIGH		1.0		$\mu\text{A}$
Assertion time	$t_{ast(PSI)}$	Fsw = 400 kHz, 4-phase, measuring from PSI falling edge to ODN falling edge	1.0		3.0	$\mu\text{s}$
De-assertion time	$t_{deast(PSI)}$	Fsw = 400 kHz, 4-phase, measuring from PSI falling edge to ODN falling edge	260		760	ns

### TRDET Output

Low Voltage	$V_{IL(TRDET)}$	$I_{TRDET(sink)} = -4\text{ mA}$		150	300	mV
-------------	-----------------	----------------------------------	--	-----	-----	----

### Oscillator

Frequency Range	$f_{OSC}$		0.25		4.0	MHz
Frequency Variation	$f_{PHASE}$	$T_A = 25^\circ\text{C}$ , $R_T = 277\text{ k}\Omega$ , 4-phase $T_A = 25^\circ\text{C}$ , $R_T = 130\text{ k}\Omega$ , 4-phase $T_A = 25^\circ\text{C}$ , $R_T = 57\text{ k}\Omega$ , 4-phase	360	200 400 800	440	kHz
Output Voltage	$V_{RT}$	$R_T = 130\text{ k}\Omega$ to GND	1.9	2.0	2.1	V
RAMP Output Voltage	$V_{RAMP}$	RAMP - FB	-50		+50	mV
RAMP Input Current Range	$I_{RAMP}$		1.0		200	$\mu\text{A}$

1. All limits at temperature extremes are guaranteed via correction using standard quality control (SQC).
2. Guaranteed by characterization, not tested in production.
3. Guaranteed by design, not tested in production.

# ADP3290

## ELECTRICAL CHARACTERISTICS ( $V_{CC} = 12\text{ V}$ , FBRTN = GND, $T_A = 0^\circ\text{C}$ to $85^\circ\text{C}$ unless otherwise noted) (Note 1)

Parameter	Symbol	Conditions	Min	Typ	Max	Unit
<b>Current Sense Amplifier</b>						
Offset Voltage	$V_{OS(CSA)}$	CSSUM - CSREF, CSREF = 0.8V ~1.6V, Temperature Range: 0 °C to 60 °C	-0.5		+0.5	mV
Input Bias Current	$I_{BIAS(CSSUM)}$	Temperature Range: 0 °C to 60 °C	-7.5		+7.5	nA
Gain Bandwidth Product	$GBW_{(CSA)}$	CSSUM = CSCOMP		10		MHz
Slew Rate		$C_{CSCOMP} = 10\text{ pF}$		10		V/ $\mu\text{s}$
Input Common-Mode Range		CSSUM and CSREF	0		3.5	V
Output Voltage Range			0.05		3.5	V
Output Current	$I_{CSCOMP}$			500		$\mu\text{A}$
Current Limit Latchoff Delay Time	$t_{OC(DELAY)}$	$C_{DELAY} = 10\text{ nF}$		8.0		ms
<b>Current Balance Amplifier</b>						
Common-Mode Range (Note 3)	$V_{SW(X)CM}$		-600		+200	mV
Input Resistance	$R_{SW(X)}$	SW(X) = 0 V	10	17	26	k $\Omega$
Input Current	$I_{SW(X)}$	SW(X) = 0 V	8.0	12	20	$\mu\text{A}$
Input Current Matching	$\Delta I_{SW(X)}$	SW(X) = 0 V	-4.0		+4.0	%
<b>IMON Output</b>						
Clamp Voltage			1.0		1.15	V
Current Gain		$(I_{MONCURRENT}) / (I_{LIMITCURRENT})$ , $R_{ILIM} = R_{IMON} = 8.0\text{ k}\Omega$ , PSI = High, Temperature Range: 0 °C to 60 °C	9.5	10	10.5	
Output Current					800	$\mu\text{A}$
Offset		$V_{CSREF} - V_{ILIMIT}$		1.2		mV
<b>Current Limit Comparator</b>						
Current Limit Threshold Current	$I_{CL}$	$4/3 \times I_{IREF}$ , PSI = High	17.7	20	22.3	$\mu\text{A}$
<b>Delay Timer</b>						
Normal Mode Output Current	$I_{DELAY}$	$I_{DELAY} = I_{IREF}$	12	15	18	$\mu\text{A}$
Output Current in Current Limit	$I_{DELAY(CL)}$	$I_{DELAY(CL)} = 0.25 \times I_{IREF}$	3.0	3.75	4.5	$\mu\text{A}$
Threshold Voltage	$V_{DELAY(TH)}$		1.6	1.7	1.8	V
<b>Soft-Start</b>						
Output Current	$I_{SS}$	During startup	13.5	17.5	21.5	$\mu\text{A}$
Soft Start slew rate	dv/dt	$C_{SS} = 8.2\text{ nF}$		2.0		mV/ $\mu\text{s}$
DVID slew rate	dv/dt	$C_{SS} = 8.2\text{ nF}$		10		mV/ $\mu\text{s}$
<b>Enable Input</b>						
Input Low Voltage	$V_{IL(EN)}$				300	mV
Input High Voltage	$V_{IH(EN)}$		800			mV
Input Current	$I_{IN(EN)}$			1.0		$\mu\text{A}$
Delay Time	$t_{DELAY(EN)}$	EN > 800 mV, $C_{DELAY} = 10\text{ nF}$		2.0		ms
<b>OD and ODN Output</b>						
Output Low Voltage	$V_{OL(OD)}$ $V_{OL(ODN)}$	$I_{OD(SINK)} = -400\text{ }\mu\text{A}$ $I_{ODN(SINK)} = -400\text{ }\mu\text{A}$		160	500	mV
Output High Voltage	$V_{OH(OD)}$ $V_{OH(ODN)}$	$I_{OD(SOURCE)} = 400\text{ }\mu\text{A}$ , $I_{ODN(SOURCE)} = 400\text{ }\mu\text{A}$	4.0	5.0		V
OD Pulldown Resistor				60		k $\Omega$
<b>Thermal Throttling Control</b>						
TTSNS Voltage Range		Internally limited	0		5.0	V
TTSNS Bias Current			-133	-123	-113	$\mu\text{A}$

1. All limits at temperature extremes are guaranteed via correction using standard quality control (SQC).
2. Guaranteed by characterization, not tested in production.
3. Guaranteed by design, not tested in production.

# ADP3290

## ELECTRICAL CHARACTERISTICS ( $V_{CC} = 12\text{ V}$ , $F_{BRTN} = \text{GND}$ , $T_A = 0^\circ\text{C}$ to $85^\circ\text{C}$ unless otherwise noted) (Note 1)

Parameter	Symbol	Conditions	Min	Typ	Max	Unit
-----------	--------	------------	-----	-----	-----	------

### Thermal Throttling Control cont.

TTSNS VRHOT Threshold Voltage			715	760	805	mV
TTSNS Hysteresis				50		mV
VRHOT Output Low Voltage	$V_{OL(VRHOT)}$	$I_{VRHOT(SINK)} = -4\text{ mA}$ , $TTSNS = 5.0\text{ V}$		150	300	mV

### Power-Good Comparator

Undervoltage Threshold	$V_{PWRGD(UV)}$	Relative to nominal DAC output	-400	-350	-300	mV
Overvoltage Threshold	$V_{PWRGD(OV)}$	Relative to nominal DAC output	100	150	200	mV
Output Low Voltage	$V_{OL(PWRGD)}$	$I_{PWRGD(SINK)} = -4\text{ mA}$		150	300	mV
Power-Good Delay Time During Soft-Start		$C_{DELAY} = 10\text{ nF}$		2.0		ms
VID Code Changing			100	250		$\mu\text{s}$
VID Code Static				200		ns
Crowbar Trip Point	$V_{CB(CSREF)}$	Relative to nominal DAC output	100	150	200	mV
Crowbar Reset Threshold		Relative to $F_{BRTN}$	305	360	415	mV
Crowbar Delay Time VID Code Changing	$t_{CROWBAR}$	Overvoltage to PWM going low	100	250		$\mu\text{s}$
VID Code Static				400		ns
PWM OUTPUTS Output Low Voltage	$V_{OL(PWM)}$	$I_{PWM(SINK)} = -400\text{ }\mu\text{A}$		160	500	mV
Output High Voltage	$V_{OH(PWM)}$	$I_{PWM(SOURCE)} = 400\text{ }\mu\text{A}$	4.0	5.0		V

### Supply

VCC	$V_{CC}$	$V_{SYSTEM} = 12\text{ V}$ , $R_{SHUNT} = 340\text{ }\Omega$	4.65	5.0	5.55	V
DC Supply Current	$I_{VCC}$	$V_{SYSTEM} = 13.2\text{ V}$ , $R_{SHUNT} = 340\text{ }\Omega$			25	mA
Shunt Turn-On Current				6.5		mA
Shunt Turn-On Threshold Voltage	$V_{SYSTEM}$	$V_{SYSTEM}$ rising		6		V
Shunt Turn-Off Voltage		$V_{SYSTEM}$ falling		4.1		V

1. All limits at temperature extremes are guaranteed via correction using standard quality control (SQC).
2. Guaranteed by characterization, not tested in production.
3. Guaranteed by design, not tested in production.

## TYPICAL CHARACTERISTICS

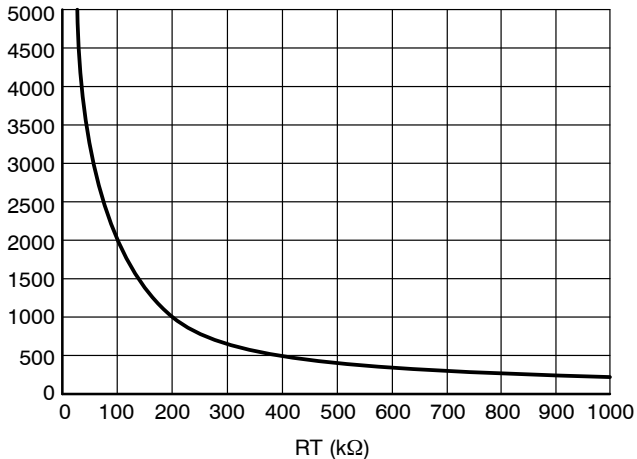

Figure 3. Oscillator Frequency vs. RT

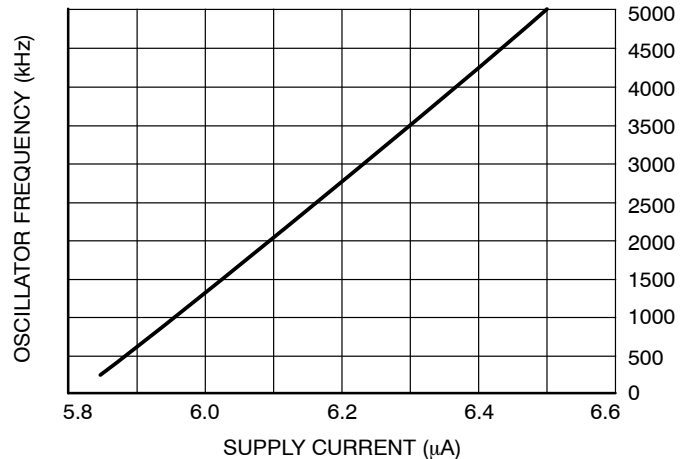

Figure 4. Oscillator Frequency vs. Supply Current



## Theory of Operation

The ADP3290 combines a multi-mode, fixed frequency PWM control with multiphase logic outputs for use in 2-, 3-, or 4-phase synchronous buck CPU core supply power converters. The internal VID DAC is designed to interface with Intel 8-bit VRD/VRM 11.1 and compatible CPUs. Multiphase operation is important for producing the high currents and low voltages demanded by today's microprocessors. Handling the high currents in a single-phase converter places high thermal demands on the components in the system, such as the inductors and MOSFETs.

The multi-mode control of the ADP3290 ensures a stable, high performance topology for the following:

- Balancing currents and thermals between phases for both static and dynamic operation
- High speed response at the lowest possible switching frequency and output decoupling
- FEPWM and TRDET functions for improved load step and load release transient response
- Minimizing thermal switching losses by using lower frequency operation
- Tight load line regulation and accuracy
- Reduced output ripple due to multiphase cancellation
- PC board layout noise immunity
- Ease of use and design due to independent component selection
- Flexibility in operation for tailoring design to low cost or high performance

## Startup Sequence

The ADP3290 follows the VR11.1 startup sequence shown in Figure 5. After both the EN and UVLO conditions are met, the DELAY pin goes through one cycle (TD1). After this cycle, the internal oscillator is enabled. The first four clock cycles are blanked from the PWM outputs and used for phase detection as explained in the Phase Detection Sequence section. Then, the soft-start ramp is enabled (TD2), and the output comes up to the boot voltage of 1.1 V. The boot hold time is determined by the DELAY pin as it goes through a third cycle (TD3). During TD3, the processor VID pins settle to the required VID code. When TD3 is over, the ADP3290 reads the VID inputs and soft-starts either up or down to the final VID voltage (TD4). When TD4 and the PWRGD masking time (equal to VID OTF masking) is completed, a third ramp on the DELAY pin sets the PWRGD blanking (TD5).

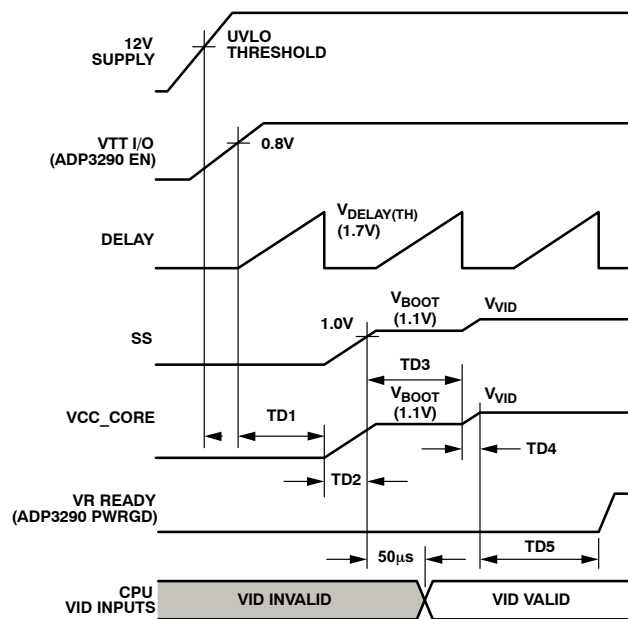

Figure 5. System Startup Sequence

## Phase Detection Sequence

During startup, the number of operational phases and their phase relationship is determined by the internal circuitry monitoring the PWM outputs. Normally, the ADP3290 operates as a 4-phase PWM controller. Connecting PWM4 pin to  $V_{CC}$  programs a 3-phase operation. For 2-phase operation, connect PWM4 and PWM3 pins to  $V_{CC}$ .

Prior to soft-start, while EN is low, the PWM3 and PWM4 pins sink approximately 100  $\mu\text{A}$ . An internal comparator checks the voltage of each pin versus a threshold of 3.15 V. If the pin is tied to  $V_{CC}$ , its voltage is above the threshold. Otherwise, an internal current sink pulls the pin to GND, which is below the threshold. PWM1 and PWM2 are low during the phase detection interval that occurs during the first four clock cycles of the internal oscillator. After this time, if the remaining PWM outputs are not pulled to  $V_{CC}$ , the 100  $\mu\text{A}$  current sink is removed, and they function as normal PWM outputs. If they are pulled to  $V_{CC}$ , the 100  $\mu\text{A}$  current source is removed, and the outputs are driven into a high impedance state.

The PWM outputs are logic-level devices intended for driving fast response external gate drivers such as the ADP3121 and ADP3122. Because each phase is monitored independently, operation approaching 100% duty cycle is possible. In addition, more than one PWM output can be on at the same time to allow overlapping phases.

### Master Clock Frequency

The clock frequency of the ADP3290 is set with an external resistor connected from the RT pin to ground. The frequency follows the graph in Figure 3. To determine the frequency per phase, the clock is divided by the number of phases in use. If all phases are in use, divide by 4. If PWM4 is tied to  $V_{CC}$ , divide by 3. If PWM4 and PWM3 are tied to  $V_{CC}$ , divide by 2.

NOTE: Single-Phase operation is also possible; contact ON Semiconductor for more details.

### Output Voltage Differential Sensing

The ADP3290 combines differential sensing with a high accuracy VID DAC and reference, and a low offset error amplifier. This maintains a worst-case specification of  $\pm 7.0$  mV differential sensing error over its full operating output voltage and with tighter accuracy over a 0 °C to 60 °C temperature range. The output voltage is sensed between the FB pin and FBRTN pin. FB is connected through a resistor to the regulation point, usually the remote sense pin of the microprocessor. FBRTN is connected directly to the remote sense ground point. The internal VID DAC and precision reference are referenced to FBRTN, which has a minimal current of 125  $\mu$ A to allow accurate remote sensing. The internal error amplifier compares the output of the DAC to the FB pin to regulate the output voltage.

### Output Current Sensing

The ADP3290 provides a dedicated current sense amplifier (CSA) to monitor the total output current for proper voltage positioning versus load current, for the  $I_{MON}$  output, and for current limit detection. Sensing the load current at the output gives the total real-time current being delivered to the load, which is an inherently more accurate method than peak current detection or sampling the current across a sense element such as the low-side MOSFET. This amplifier can be configured several ways, depending on the objectives of the system, as follows:

- Output inductor DCR sensing without a thermistor for lowest cost.
- Output inductor DCR sensing with a thermistor for improved accuracy with tracking of inductor temperature.
- Sense resistors for highest accuracy measurements.

The positive input of the CSA is connected to the CSREF pin, which is connected to the average output voltage. The inputs to the amplifier are summed together through resistors from the sensing element, such as the switch node side of the output inductors, to the inverting input CSSUM. The feedback resistor between CSCOMP and CSSUM sets the gain of the amplifier and a filter capacitor is placed in parallel with this resistor. The gain of the amplifier is programmable by adjusting the input summing resistor.

An additional resistor divider connected between CSREF and CSCOMP (with the midpoint connected to LLINE) can

be used to set the load line required by the microprocessor. The current information is then given as CSREF – LLINE. This difference signal is used internally to offset the VID DAC for voltage positioning. The difference between CSREF and CSCOMP is then used as a differential input for the current limit comparator. This allows the load line to be set independently of the current limit threshold. In the event that the current limit threshold and load line are not independent, the resistor divider between CSREF and CSCOMP can be removed and the CSCOMP pin can be directly connected to LLINE. To disable voltage positioning entirely (that is, no load line) connect LLINE to CSREF.

To provide the best accuracy for sensing current, the CSA is designed to have a low offset input voltage. Also, the sensing gain is determined by external resistors to make it extremely accurate.

### Active Impedance Control Mode

For controlling the dynamic output voltage droop as a function of output current, a signal proportional to the total output current at the LLINE pin can be scaled to equal the regulator droop impedance multiplied by the output current. This droop voltage is then used to set the input control voltage to the system. The droop voltage is subtracted from the DAC reference input voltage to tell the error amplifier where the output voltage should be. This allows enhanced feed-forward response.

### Current Control Mode and Thermal Balance

The ADP3290 has individual inputs (SW1 to SW4) for each phase that are used for monitoring the current of each phase. This information is combined with an internal ramp to create a current balancing feedback system that has been optimized for initial current balance accuracy and dynamic thermal balancing during operation. This current balance information is independent of the average output current information used for positioning as described in the Load Line Setting section.

The magnitude of the internal ramp can be set to optimize the transient response of the system. It also monitors the supply voltage for feed-forward control for changes in the supply. A resistor connected from the power input voltage to the RAMP pin determines the slope of the internal PWM ramp.

External resistors can be placed in series with individual phases to create an intentional current imbalance if desired, such as when one phase has better cooling and can support higher currents. Resistor  $R_{SW1}$  through  $R_{SW4}$  can be used for adjusting thermal balance. It is best to have the ability to add these resistors during the initial design, therefore, ensure that placeholders are provided in the layout.

To increase the current in any given phase, enlarge  $R_{SW}$  for that phase (make  $R_{SW} = 0$  for the hottest phase and do not change it during balancing). Increasing  $R_{SW}$  by 1 k $\Omega$  can make an increase in phase current. Increase each  $R_{SW}$  value by small amounts to achieve balance, starting with the coolest phase first.

### Voltage Control Mode

A high gain, bandwidth voltage mode error amplifier is used for the voltage mode control loop. The control input voltage to the positive input is set via the VID logic according to the voltages listed.

This voltage is also offset by the droop voltage for active positioning of the output voltage as a function of current, commonly known as active voltage positioning. The output of the amplifier is the COMP pin, which sets the termination voltage for the internal PWM ramps.

The negative input (FB) is tied to the output sense location with Resistor  $R_B$  and is used for sensing and controlling the output voltage at this point. A current source from the FB pin flowing through  $R_B$  is used for setting the no load offset voltage from the VID voltage. The no load voltage is negative with respect to the VID DAC. The main loop compensation is incorporated into the feedback network between FB and COMP.

### Fast Enhanced Transient Modes

The ADP3290 incorporates enhanced transient response for both load steps and load release. For load steps, it senses the error amp to determine if a load step has occurred and sequences the proper number of phases on to ramp up the output current.

For load release, it also senses the error amp and uses the load release information to trigger the TRDET pin, which is then used to adjust the feedback for optimal positioning especially during high frequency load steps.

Additional information is used during load transients to ensure proper sequencing and balancing of phases during high frequency load steps as well as minimizing stress on the components such as the input filter and MOSFETs.

### Delay Timer

The delay times for the startup timing sequence are set with a capacitor from the DELAY pin to ground. In UVLO, or when EN is logic low, the DELAY pin is held at ground. After the UVLO and EN signals are asserted, the first delay time (TD1 in Figure 5) is initiated. A 15  $\mu\text{A}$  current flows out of the DELAY pin to charge  $C_{DLY}$ . A comparator monitors the DELAY voltage with a threshold of 1.7 V. The delay time is therefore set by the 15  $\mu\text{A}$  charging a capacitor from 0 V to 1.7 V. This DELAY pin is used for multiple delay timings (TD1, TD3, and TD5) during the startup sequence. Also, DELAY is used for timing the current limit latchoff, as explained in the Current Limit, Short-Circuit, and Latchoff Protection section.

### Soft-Start

The soft-start times for the output voltage are set with a capacitor from the SS pin to ground. After TD1 and the phase detection cycle have been completed, the SS time (TD2 in Figure 5) starts. The SS pin is disconnected from

GND, and the capacitor is charged up to the 1.1 V boot voltage by the SS amplifier, which has a limited output current of 15  $\mu\text{A}$ . The voltage at the FB pin follows the ramping voltage on the SS pin, limiting the inrush current during startup. The soft-start time depends on the value of the boot voltage and  $C_{SS}$ .

Once the SS voltage is within 100 mV of the boot voltage, the boot voltage delay time (TD3 in Figure 5) is started. The end of the boot voltage delay time signals the beginning of the second soft-start time (TD4 in Figure 5). The SS voltage now changes from the boot voltage to the programmed VID DAC voltage (either higher or lower) using the SS amplifier with the limited 15  $\mu\text{A}$  output current. The voltage of the FB pin follows the ramping voltage of the SS pin, limiting the inrush current during the transition from the boot voltage to the final DAC voltage. The second soft-start time depends on the boot voltage, the programmed VID DAC voltage, and  $C_{SS}$ .

Once TD5 has finished, the SS pin is then used to limit the slew-rate of DVID steps. The current source is changed to 75  $\mu\text{A}$  and the DVID slew-rate becomes 5 X the soft-start slew-rate. Typically, the SS slew-rate is 2 mV/ $\mu\text{s}$ , so the DVID becomes 10 mV/ $\mu\text{s}$ .

If EN is taken low or if  $V_{CC}$  drops below UVLO, DELAY and SS are reset to ground to be ready for another soft-start cycle. Figure 6 shows typical startup waveforms for the ADP3290.

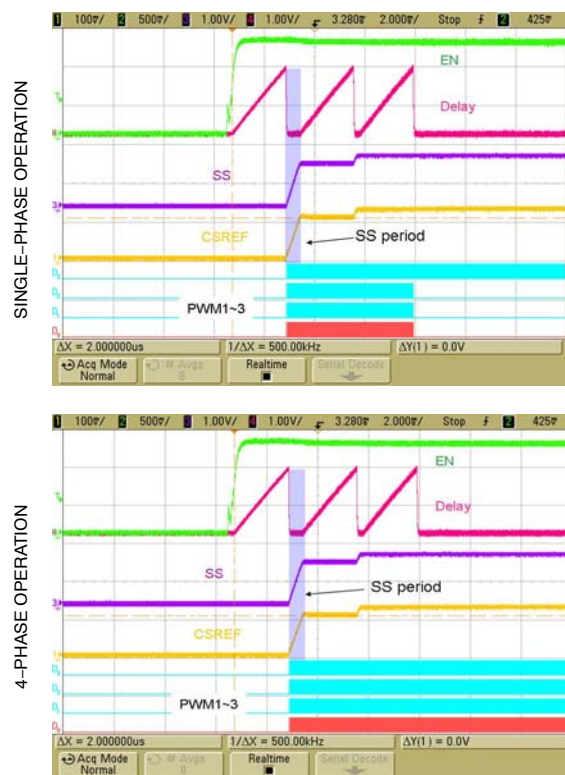

Figure 6. Typical Startup Waveform  
1-Vo, 2-EN, 3-SS, 4-DELAY, D0-D3-PWM1~4

### Current Limit, Short-Circuit, and Latchoff Protection

The ADP3290 compares a programmable current limit set point to the voltage from the output of the current sense amplifier. The level of current limit is set with the resistor from the  $I_{LIM}$  pin to CSCOMP. During operation, the voltage on  $I_{LIM}$  is equal to the voltage on CSREF. The current through the external resistor connected between  $I_{LIM}$  and CSCOMP is then compared to the internal current limit current  $I_{cl}$ . If the current generated through this register into the  $I_{LIM}$  pin ( $I_{LIM}$ ) exceeds the internal current limit threshold current ( $I_{cl}$ ), the internal current limit amplifier controls the internal COMP voltage to maintain the average output at the limit.

If the limit is reached and TD5 in Figure 5 has completed, a latchoff delay time starts, and the controller shuts down if the fault is not removed. The current limit delay time shares the DELAY pin timing capacitor with the startup sequence timing. However, during current limit, the DELAY pin current is reduced to  $3.75\ \mu\text{A}$ . A comparator monitors the DELAY voltage and shuts off the controller when the voltage reaches 1.7 V. Therefore, the current limit latchoff delay time is set by the current of  $3.75\ \mu\text{A}$ , charging the delay capacitor from 0 V to 1.7 V. This delay is four times longer than the delay time during the startup sequence.

The current limit delay time starts only after the TD5 is complete. If there is a current limit during startup, the ADP3290 goes through TD1 to TD5, and then starts the latchoff time. Because the controller continues to cycle the phases during the latchoff delay time, the controller returns to normal operation and the DELAY capacitor is reset to GND if the short is removed before the 1.7 V threshold is reached.

The latchoff function can be reset by either removing and reapplying the supply voltage to the ADP3290, or by toggling the EN pin low for a short time. To disable the short circuit latchoff function, an external resistor should be placed in parallel with  $C_{DLY}$ . This prevents the DELAY capacitor from charging up to the 1.7 V threshold. The addition of this resistor causes a slight increase in the delay times.

During startup, when the output voltage is below 200 mV, a secondary current limit is active. This is necessary because the voltage swing of CSCOMP cannot go below ground. This secondary current limit controls the internal COMP voltage to the PWM comparators to 1.5 V. This limits the voltage drop across the low-side MOSFETs through the current balance circuitry. An inherent per-phase current limit protects individual phases if one or more phases stop functioning because of a faulty component. This limit is based on the maximum normal mode COMP voltage. Typical overcurrent latchoff waveforms are shown in Figure 7.

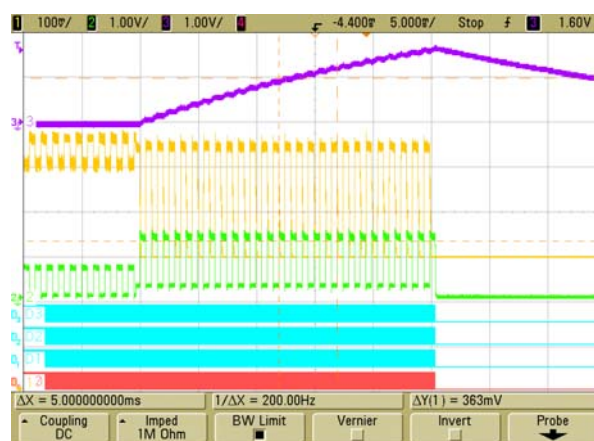

**Figure 7. Dynamic (Load Transient) Overcurrent Latchoff Waveform**  
1-Vo, 2-Io(from VTT), 3-DELAY, D0~D3-PWM1~4

### Output Current Monitor

The  $I_{MON}$  pin is used to output an analog voltage representing the total output current being delivered to the load. It outputs an accurate current that is directly proportional to the current set by the  $I_{LIM}$  resistor. This current is then run through a parallel RC connected from the  $I_{MON}$  pin to the FBRTN pin to generate an accurately scaled and filtered voltage per the VR11.1 specification. The size of the resistor is used to set the  $I_{MON}$  scaling.

If the  $I_{MON}$  and OCP are then desired to be changed based on the TDC of the CPU, the  $I_{LIM}$  resistor is the only component that needs to be changed. If the  $I_{MON}$  scaling is the only desired change, then just changing the  $I_{MON}$  resistor accomplishes this.

The  $I_{MON}$  pin also includes an active clamp to limit the  $I_{MON}$  voltage to 1.15 V MAX yet maintaining 900 mV MIN full-scale accurate reporting.

### Dynamic VID

The ADP3290 has the ability to dynamically change the VID inputs while the controller is running. This allows the output voltage to change while the supply is running and supplying current to the load. This is commonly referred to as dynamic VID (DVID). A DVID can occur under light or heavy load conditions. The processor signals the controller by changing the VID inputs in multiple steps from the start code to the finish code. This change can be positive or negative.

When a VID input changes state, the ADP3290 detects the change and ignores the DAC inputs for a minimum of 400 ns. This time prevents a false code due to logic skew while the eight VID inputs are changing. Additionally, the first VID change initiates the PWRGD and crowbar blanking functions for a minimum of 100  $\mu\text{s}$  to prevent a false PWRGD or crowbar event. Each VID change resets the internal timer.

If an OFF VID code is detected, the ADP3290 waits 5  $\mu\text{s}$  to ensure this code is correct before initiating a shutdown of the controller.



The ADP3290 also adds the use of the SS pin to limit DVID slew-rates. These can be encountered when the system does a large single VID step for power state changes, thus the DVID slew-rate needs to be limited to prevent large in-rush currents. The SS pin uses a 75  $\mu$ A current source into the SS capacitor to do this limiting and typical slew-rates of 10mV/ $\mu$ S are set with the design.

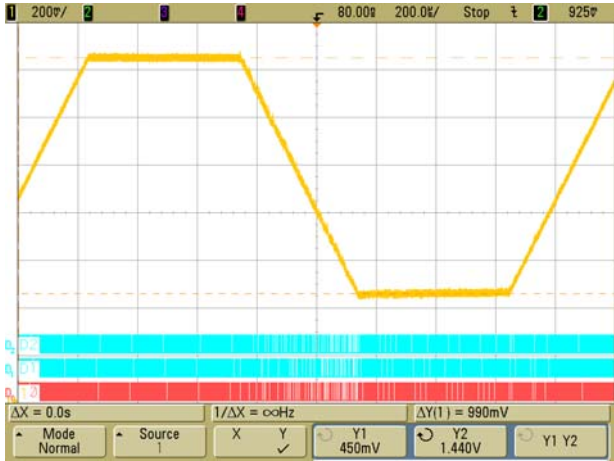

**Figure 8. DVID Waveform (by VTT, 0.5 V-1.5V)  
1-Vo D0~D2-PWM1~3**

**Power-Good Monitoring**

The power-good comparator monitors the output voltage via the CSREF pin. The PWRGD pin is an open-drain output whose high level, when connected to a pullup resistor, indicates that the output voltage is within the nominal limits specified based on the VID voltage setting. PWRGD goes low if the output voltage is outside of this specified range, if the VID DAC inputs are in no CPU mode, or if the EN pin is pulled low. PWRGD is blanked during a DVID event for a period of 250  $\mu$ s to prevent false signals during the time the output is changing.

The PWRGD circuitry also incorporates an initial turn-on delay time (TD5), based on the DELAY timer. Prior to the SS voltage reaching the programmed VID DAC voltage and the PWRGD masking-time finishing, the PWRGD pin is held low. Once the SS pin is within 100 mV of the programmed DAC voltage, the capacitor on the DELAY pin begins to charge. A comparator monitors the DELAY voltage and enables PWRGD when the voltage reaches 1.7 V. The PWRGD delay time is, therefore, set by a current of 15  $\mu$ A, charging a capacitor from 0 V to 1.7 V.

**Power State Indicator**

The  $\overline{\text{PSI}}$  pin is used as an input to determine the operating power state of the load. If this pin is pulled low, the controller knows the load is in a low power state and it takes the  $\overline{\text{ODN}}$  signal low, which can be used to disable phases for increased efficiency.

The sequencing into and out of low-power operation is maintained to minimize output voltage deviations as well as

providing full-power load transients immediately following exit from a low-power state.

One additional feature of the ADP3290 is the internal current limit threshold is changed when  $\overline{\text{PSI}}$  is pulled low. The current limit threshold is reduced by 1/N such that the same per phase average current limit is maintained to protect the components in the system.

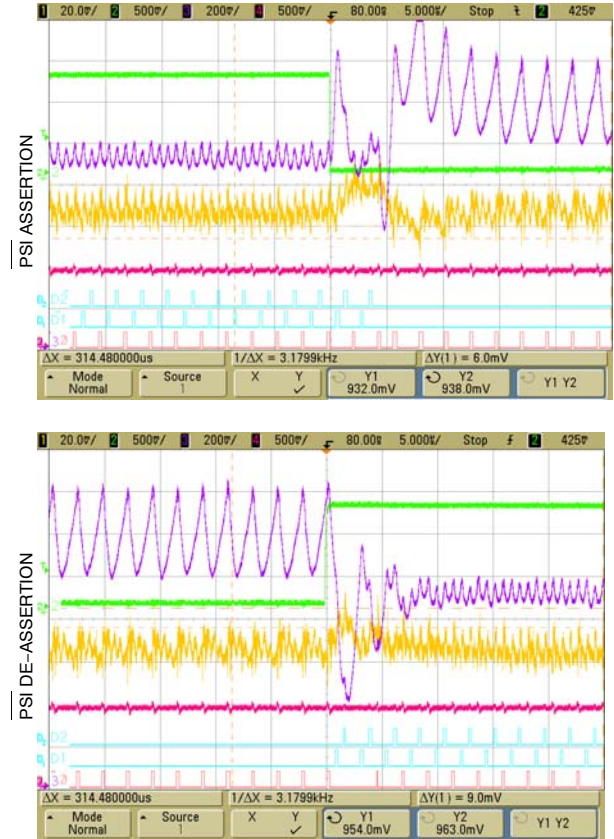

**Figure 9.  $\overline{\text{PSI}}$  Mode Transition Waveform ( $I_o = 25A$ )  
1-Vo, 2- $\overline{\text{PSI}}$ , 3-COMP, 4-TRDET, D0~D2-PWM1~3**

**Output Crowbar**

To protect the load and output components of the supply, the PWM outputs are driven low, which turns on the low-side MOSFETs when the output voltage exceeds the upper crowbar threshold. This crowbar action stops once the output voltage falls below the release threshold of approximately 375 mV.

Turning on the low-side MOSFETs pulls down the output as the reverse current builds up in the inductors. If the output overvoltage is due to a short in the high-side MOSFET, this action current limits the input supply or blows its fuse, protecting the microprocessor from being destroyed.

**Output Enable and UVLO**

For the ADP3290 to begin switching, the input supply current to the controller must be higher than the UVLO threshold and the EN pin must be higher than its 0.8 V threshold. This initiates a system startup sequence. If either

## ADP3290

UVLO or EN is less than their respective thresholds, the ADP3290 is disabled. This holds the PWM outputs at ground, shorts the DELAY capacitor to ground, and the forces PWRGD and  $\overline{OD}$  signals low.

In the application circuit, the  $\overline{OD}$  pin should be connected to the  $\overline{OD}$  input of the external driver for the phase that is always on while the  $\overline{ODN}$  pin should be connected to the  $\overline{OD}$  input on the external drivers of the phases that are shut off during low-power operation. Grounding  $\overline{OD}$  and  $\overline{ODN}$  disable the drivers such that both DRVH and DRVL are grounded. This feature is important in preventing the discharge of the output capacitors when the controller is shut off. If the driver outputs are not disabled, a negative voltage can be generated during output due to the high current discharge of the output capacitors through the inductors.

### Thermal Monitoring

The ADP3290 includes a thermal monitoring circuit to detect when a point on the VR has exceeded a user-defined temperature. The thermal monitoring circuit requires an NTC thermistor to be placed between TTSNS and GND.

A fixed current of 120  $\mu$ A is sourced out of the TTSNS pin and into the thermistor. The current source is internally limited to 5.0 V. An internal circuit compares the TTSNS voltage to a 0.81 V threshold, and outputs an open-drain signal at the VRHOT output. Once the voltage on the TTSNS pin drops below its threshold, the open-drain output asserts high to signal the system that an overtemperature event has occurred. Because the TTSNS voltage changes slowly with respect to time, 55 mV of hysteresis is built into this comparator. The thermal monitoring circuitry does not depend on EN and is active when UVLO is above its threshold. When UVLO is below its threshold, VRHOT is forced low.

### VR11.1 VID Codes

OUTPUT(V)	VID7	VID6	VID5	VID4	VID3	VID2	VID1	VID0
OFF	0	0	0	0	0	0	0	0
OFF	0	0	0	0	0	0	0	1
1.60000	0	0	0	0	0	0	1	0
1.59375	0	0	0	0	0	0	1	1
1.58750	0	0	0	0	0	1	0	0
1.58125	0	0	0	0	0	1	0	1
1.57500	0	0	0	0	0	1	1	0
1.56875	0	0	0	0	0	1	1	1
1.56250	0	0	0	0	1	0	0	0
1.55625	0	0	0	0	1	0	0	1
1.55000	0	0	0	0	1	0	1	0
1.54375	0	0	0	0	1	0	1	1
1.53750	0	0	0	0	1	1	0	0
1.53125	0	0	0	0	1	1	0	1
1.52500	0	0	0	0	1	1	1	0
1.51875	0	0	0	0	1	1	1	1
1.51250	0	0	0	1	0	0	0	0
1.50625	0	0	0	1	0	0	0	1
1.50000	0	0	0	1	0	0	1	0
1.49375	0	0	0	1	0	0	1	1
1.48750	0	0	0	1	0	1	0	0
1.48125	0	0	0	1	0	1	0	1
1.47500	0	0	0	1	0	1	1	0
1.46875	0	0	0	1	0	1	1	1
1.46250	0	0	0	1	1	0	0	0
1.45625	0	0	0	1	1	0	0	1
1.45000	0	0	0	1	1	0	1	0
1.44375	0	0	0	1	1	0	1	1
1.43750	0	0	0	1	1	1	0	0
1.43125	0	0	0	1	1	1	0	1
1.42500	0	0	0	1	1	1	1	0
1.41875	0	0	0	1	1	1	1	1
1.41250	0	0	1	0	0	0	0	0

# ADP3290

## VR11.1 VID Codes

OUTPUT(V)	VID7	VID6	VID5	VID4	VID3	VID2	VID1	VID0
1.40625	0	0	1	0	0	0	0	1
1.40000	0	0	1	0	0	0	1	0
1.39375	0	0	1	0	0	0	1	1
1.38750	0	0	1	0	0	1	0	0
1.38125	0	0	1	0	0	1	0	1
1.37500	0	0	1	0	0	1	1	0
1.36875	0	0	1	0	0	1	1	1
1.36250	0	0	1	0	1	0	0	0
1.35625	0	0	1	0	1	0	0	1
1.35000	0	0	1	0	1	0	1	0
1.34375	0	0	1	0	1	0	1	1
1.33750	0	0	1	0	1	1	0	0
1.33125	0	0	1	0	1	1	0	1
1.32500	0	0	1	0	1	1	1	0
1.31875	0	0	1	0	1	1	1	1
1.31250	0	0	1	1	0	0	0	0
1.30625	0	0	1	1	0	0	0	1
1.30000	0	0	1	1	0	0	1	0
1.29375	0	0	1	1	0	0	1	1
1.28750	0	0	1	1	0	1	0	0
1.28125	0	0	1	1	0	1	0	1
1.27500	0	0	1	1	0	1	1	0
1.26875	0	0	1	1	0	1	1	1
1.26250	0	0	1	1	1	0	0	0
1.25625	0	0	1	1	1	0	0	1
1.25000	0	0	1	1	1	0	1	0
1.24375	0	0	1	1	1	0	1	1
1.23750	0	0	1	1	1	1	0	0
1.23125	0	0	1	1	1	1	0	1
1.22500	0	0	1	1	1	1	1	0
1.21875	0	0	1	1	1	1	1	1
1.21250	0	1	0	0	0	0	0	0
1.20625	0	1	0	0	0	0	0	1
1.20000	0	1	0	0	0	0	1	0
1.19375	0	1	0	0	0	0	1	1
1.18750	0	1	0	0	0	1	0	0
1.18125	0	1	0	0	0	1	0	1
1.17500	0	1	0	0	0	1	1	0
1.16875	0	1	0	0	0	1	1	1
1.16250	0	1	0	0	1	0	0	0
1.15625	0	1	0	0	1	0	0	1
1.15000	0	1	0	0	1	0	1	0
1.14375	0	1	0	0	1	0	1	1
1.13750	0	1	0	0	1	1	0	0
1.13125	0	1	0	0	1	1	0	1
1.12500	0	1	0	0	1	1	1	0
1.11875	0	1	0	0	1	1	1	1
1.11250	0	1	0	1	0	0	0	0
1.10625	0	1	0	1	0	0	0	1
1.10000	0	1	0	1	0	0	1	0

# ADP3290

## VR11.1 VID Codes

OUTPUT(V)	VID7	VID6	VID5	VID4	VID3	VID2	VID1	VID0
1.09375	0	1	0	1	0	0	1	1
1.08750	0	1	0	1	0	1	0	0
1.08125	0	1	0	1	0	1	0	1
1.07500	0	1	0	1	0	1	1	0
1.06875	0	1	0	1	0	1	1	1
1.06250	0	1	0	1	1	0	0	0
1.05625	0	1	0	1	1	0	0	1
1.05000	0	1	0	1	1	0	1	0
1.04375	0	1	0	1	1	0	1	1
1.03750	0	1	0	1	1	1	0	0
1.03125	0	1	0	1	1	1	0	1
1.02500	0	1	0	1	1	1	1	0
1.01875	0	1	0	1	1	1	1	1
1.01250	0	1	1	0	0	0	0	0
1.00625	0	1	1	0	0	0	0	1
1.00000	0	1	1	0	0	0	1	0
0.99375	0	1	1	0	0	0	1	1
0.98750	0	1	1	0	0	1	0	0
0.98125	0	1	1	0	0	1	0	1
0.97500	0	1	1	0	0	1	1	0
0.96875	0	1	1	0	0	1	1	1
0.96250	0	1	1	0	1	0	0	0
0.95625	0	1	1	0	1	0	0	1
0.95000	0	1	1	0	1	0	1	0
0.94375	0	1	1	0	1	0	1	1
0.93750	0	1	1	0	1	1	0	0
0.93125	0	1	1	0	1	1	0	1
0.92500	0	1	1	0	1	1	1	0
0.91875	0	1	1	0	1	1	1	1
0.91250	0	1	1	1	0	0	0	0
0.90625	0	1	1	1	0	0	0	1
0.90000	0	1	1	1	0	0	1	0
0.89375	0	1	1	1	0	0	1	1
0.88750	0	1	1	1	0	1	0	0
0.88125	0	1	1	1	0	1	0	1
0.87500	0	1	1	1	0	1	1	0
0.86875	0	1	1	1	0	1	1	1
0.86250	0	1	1	1	1	0	0	0
0.85625	0	1	1	1	1	0	0	1
0.85000	0	1	1	1	1	0	1	0
0.84375	0	1	1	1	1	0	1	1
0.83750	0	1	1	1	1	1	0	0
0.83125	0	1	1	1	1	1	0	1
0.82500	0	1	1	1	1	1	1	0
0.81875	0	1	1	1	1	1	1	1
0.81250	1	0	0	0	0	0	0	0
0.80625	1	0	0	0	0	0	0	1
0.80000	1	0	0	0	0	0	1	0
0.79375	1	0	0	0	0	0	1	1
0.78750	1	0	0	0	0	1	0	0



# ADP3290

## VR11.1 VID Codes

OUTPUT(V)	VID7	VID6	VID5	VID4	VID3	VID2	VID1	VID0
0.78125	1	0	0	0	0	1	0	1
0.77500	1	0	0	0	0	1	1	0
0.76875	1	0	0	0	0	1	1	1
0.76250	1	0	0	0	1	0	0	0
0.75625	1	0	0	0	1	0	0	1
0.75000	1	0	0	0	1	0	1	0
0.74375	1	0	0	0	1	0	1	1
0.73750	1	0	0	0	1	1	0	0
0.73125	1	0	0	0	1	1	0	1
0.72500	1	0	0	0	1	1	1	0
0.71875	1	0	0	0	1	1	1	1
0.71250	1	0	0	1	0	0	0	0
0.70625	1	0	0	1	0	0	0	1
0.70000	1	0	0	1	0	0	1	0
0.69375	1	0	0	1	0	0	1	1
0.68750	1	0	0	1	0	1	0	0
0.68125	1	0	0	1	0	1	0	1
0.67500	1	0	0	1	0	1	1	0
0.66875	1	0	0	1	0	1	1	1
0.66250	1	0	0	1	1	0	0	0
0.65625	1	0	0	1	1	0	0	1
0.65000	1	0	0	1	1	0	1	0
0.64375	1	0	0	1	1	0	1	1
0.63750	1	0	0	1	1	1	0	0
0.63125	1	0	0	1	1	1	0	1
0.62500	1	0	0	1	1	1	1	0
0.61875	1	0	0	1	1	1	1	1
0.61250	1	0	1	0	0	0	0	0
0.60625	1	0	1	0	0	0	0	1
0.60000	1	0	1	0	0	0	1	0
0.59375	1	0	1	0	0	0	1	1
0.58750	1	0	1	0	0	1	0	0
0.58125	1	0	1	0	0	1	0	1
0.57500	1	0	1	0	0	1	1	0
0.56875	1	0	1	0	0	1	1	1
0.56250	1	0	1	0	1	0	0	0
0.55625	1	0	1	0	1	0	0	1
0.55000	1	0	1	0	1	0	1	0
0.54375	1	0	1	0	1	0	1	1
0.53750	1	0	1	0	1	1	0	0
0.53125	1	0	1	0	1	1	0	1
0.52500	1	0	1	0	1	1	1	0
0.51875	1	0	1	0	1	1	1	1
0.51250	1	0	1	1	0	0	0	0
0.50625	1	0	1	1	0	0	0	1
0.50000	1	0	1	1	0	0	1	0
OFF	1	1	1	1	1	1	1	0
OFF	1	1	1	1	1	1	1	1

### Application Information

The design parameters for a typical Intel VRD 11.1 compliant CPU application are as follows:

- Input voltage ( $V_{IN}$ ) = 12 V
- VID setting voltage ( $V_{VID}$ ) = 1.400 V
- Duty cycle ( $D$ ) = 0.117
- Nominal output voltage at no load ( $V_{ONL}$ ) = 1.381 V
- Nominal output voltage at 115 A load ( $V_{OFL}$ ) = 1.266 V
- Static output voltage drop based on a 1.0 m $\Omega$  load line ( $R_O$ ) from no load to full load ( $V_D$ ) =  $V_{ONL} - V_{OFL} = 1.381 \text{ V} - 1.266 \text{ V} = 115 \text{ mV}$
- Maximum output current ( $I_O$ ) = 130 A
- Maximum output current step ( $\Delta I_O$ ) = 95 A
- Maximum output current slew rate ( $S_R$ ) = 200 A/ $\mu\text{s}$
- Number of phases ( $n$ ) = 4
- Switching frequency per phase ( $f_{SW}$ ) = 450 kHz

### Setting the Clock Frequency

The ADP3290 uses a fixed frequency control architecture. The frequency is set by an external timing resistor ( $R_T$ ). The clock frequency and the number of phases determine the switching frequency per phase, which relates directly to switching losses as well as the sizes of the inductors, the input capacitors, and output capacitors. With  $n = 4$  for four phases, a clock frequency of 18 MHz sets the switching frequency ( $f_{SW}$ ) of each phase to 450 kHz, which represents a practical trade off between the switching losses and the sizes of the output filter components. Figure 3 shows that to achieve a 1.32 MHz oscillator frequency, the correct value for  $R_T$  is 130 k $\Omega$ . Alternatively, the value for  $R_T$  can be calculated using:

$$R_T = \frac{1}{n \times f_{SW} \times 4.3 \text{ pF}} - 17 \text{ k}\Omega \quad (\text{eq. 1})$$

where 4.3 pF is the internal IC component values. For good initial accuracy and frequency stability, a 1% resistor is recommended.

### Soft-Start Delay Time

The value of  $C_{SS}$  sets the soft-start time. The ramp is generated with a 15  $\mu\text{A}$  internal current source. The value for  $C_{SS}$  can be found using:

$$C_{SS} = 15 \mu\text{A} \times \frac{TD2}{V_{BOOT}} \quad (\text{eq. 2})$$

where  $TD2$  is the desired soft-start time, and  $V_{BOOT}$  is internally set to 1.0 V.

Assuming a desired  $TD2$  time of 2.5 ms,  $C_{SS}$  is 37.5 nF. The closest standard value for  $C_{SS}$  is 39 nF. Although  $C_{SS}$  also controls the time delay for  $TD4$  (determined by the final VID voltage), the minimum specification for  $TD4$  is 0 ns. This means that as long as the  $TD2$  time requirement is met,  $TD4$  is within the specification.

### Current Limit Latchoff Delay Times

The startup and current limit delay times are determined by the capacitor connected to the DELAY pin. The first step is to set  $C_{DLY}$  for the  $TD1$ ,  $TD3$ , and  $TD5$  delay times (see Figure 5). The DELAY ramp ( $I_{DELAY}$ ) is generated using a 15  $\mu\text{A}$  internal current source.

The value for  $C_{DLY}$  can be approximated using:

$$C_{DLY} = I_{DELAY} \times \frac{TD(x)}{V_{DELAY(TH)}} \quad (\text{eq. 3})$$

where  $TD(x)$  is the desired delay time for  $TD1$ ,  $TD3$ , and  $TD5$ . The DELAY threshold voltage ( $V_{DELAY(TH)}$ ) is given as 1.7 V. In this example, 2 ms is chosen for all three delay times, which meets Intel specifications. Solving for  $C_{DLY}$  gives a value of 17.6 nF. The closest standard value for  $C_{DLY}$  is 18 nF.

When the ADP3290 enters current limit, the internal current source changes from 15  $\mu\text{A}$  to 3.75  $\mu\text{A}$ . This makes the latchoff delay time four times longer than the startup delay time. Longer latchoff delay times can be achieved by placing a resistor in parallel with  $C_{DLY}$ .

### Inductor Selection

The choice of inductance for the inductor determines the ripple current in the inductor. Less inductance leads to more ripple current, which increases the output ripple voltage and conduction losses in the MOSFETs. However, using smaller inductors allows the converter to meet a specified peak-to-peak transient deviation with less total output capacitance. Conversely, a higher inductance means lower ripple current and reduced conduction losses, but more output capacitance is required to meet the same peak-to-peak transient deviation.

In any multiphase converter, a practical value for the peak-to-peak inductor ripple current is less than 50% of the maximum dc current in the same inductor. Equation 4 shows the relationship between the inductance, oscillator frequency, and peak-to-peak ripple current in the inductor.

$$I_R = \frac{V_{VID} \times (1 - D)}{f_{SW} \times L} \quad (\text{eq. 4})$$

Equation 5 can be used to determine the minimum inductance based on a given output ripple voltage.

$$L \geq \frac{V_{VID} \times R_O \times (1 - (n \times D))}{f_{SW} \times V_{RIPPLE}} \quad (\text{eq. 5})$$

Solving Equation 5 for an 8 mV p-p output ripple voltage yields:

$$L \geq \frac{1.4 \text{ V} \times 1.0 \text{ m}\Omega \times (1 - 0.468)}{450 \text{ kHz} \times 10 \text{ mV}} = 166 \text{ nH}$$

If the resulting ripple voltage is less than what is designed for, the inductor can be made smaller until the ripple value is met. This allows optimal transient response and minimum output decoupling.

The smallest possible inductor should be used to minimize the number of output capacitors. For this example, choosing a 220 nH inductor is a good starting point and gives a calculated ripple current of 12.5 A. The inductor should not saturate at the peak current of 38.7 A and should be able to handle the sum of the power dissipation caused by the average current of 32.5 A in the winding and core loss.

Another important factor in the inductor design is the dc resistance (DCR), which is used for measuring the phase currents. A large DCR can cause excessive power losses, though too small a value can lead to increased measurement error. A good rule is to have the DCR ( $R_L$ ) be about 1 to 1.5 times the droop resistance ( $R_O$ ). This example uses an inductor with a DCR of 0.57 m $\Omega$ .

### Designing an Inductor

Once the inductance and DCR are known, the next step is to either design an inductor or to find a standard inductor that comes as close as possible to meeting the overall design goals. It is also important to have the inductance and DCR tolerance specified to control the accuracy of the system. Reasonable tolerances most manufacturers can meet are 15% inductance and 7% DCR at room temperature. The first decision in designing the inductor is choosing the core material. Several possibilities for providing low core loss at high frequencies include the powder cores (from Micrometals, Inc., for example, or Kool Mu<sup>®</sup> from Magnetics<sup>®</sup>) and the gapped soft ferrite cores (for example, 3F3 or 3F4 from Philips<sup>®</sup>). Low frequency powdered iron cores should be avoided due to their high core loss, especially when the inductor value is relatively low and the ripple current is high.

The best choice for a core geometry is a closed-loop type such as a potentiometer core (PQ, U, or E core) or toroid. A good compromise between price and performance is a core with a toroidal shape.

Many useful magnetics design references are available for quickly designing a power inductor, such as:

- Intusoft Magnetic Designer Software
- Designing Magnetic Components for High Frequency DC to DC Converters, by William T. McLyman, Kg Magnetics, Inc., ISBN 1883107008

### Selecting a Standard Inductor

The following power inductor manufacturers can provide design consultation and deliver power inductors optimized for high power applications upon request.

- Coilcraft<sup>®</sup>
- Coiltronics<sup>®</sup>
- Sumida Corporation<sup>®</sup>

### Current Sense Amplifier

Most designs require the regulator output voltage, measured at the CPU pins, to drop when the output current

increases. The specified voltage drop corresponds to a dc output resistance ( $R_O$ ), also referred to as a load line. The ADP3290 has the flexibility of adjusting  $R_O$ , independent of current limit or compensation components, and it can also support CPUs that do not require a load line.

For designs requiring a load line, the impedance gain of the CS amplifier ( $R_{CSA}$ ) must be to be greater than or equal to the load line. All designs, whether they have a load line or not, should keep  $R_{CSA} \geq 1 \text{ m}\Omega$ .

The output current is measured by summing the voltage across each inductor and passing the signal through a low-pass filter. This summer filter is the CS amplifier configured with resistors  $R_{PH(X)}$  (summers), and  $R_{CS}$  and  $C_{CS}$  (filter). The impedance gain of the regulator is set by the following equations, where  $R_L$  is the DCR of the output inductors:

$$R_{CSA} = \frac{R_{CS}}{R_{PH(X)}} \times R_L \quad (\text{eq. 6})$$

$$C_{CS} = \frac{L}{R_L \times R_{CS}} \quad (\text{eq. 7})$$

The user has the flexibility to choose either  $R_{CS}$  or  $R_{PH(X)}$ . However, it is best to select  $R_{CS}$  equal to 110 k $\Omega$ , and then solve for  $R_{PH(X)}$  by rearranging Equation 6. Here,  $R_{CSA} = R_O = 1 \text{ m}\Omega$  because this is equal to the design load line.

$$R_{PH(X)} = \frac{R_L}{R_{CSA}} \times R_{CS}$$

$$R_{PH(X)} = \frac{0.57 \text{ m}\Omega}{1.0 \text{ m}\Omega} \times 110 \text{ k}\Omega = 63 \text{ k}\Omega$$

Next, use Equation 7 to solve for  $C_{CS}$ .

$$C_{CS} = \frac{220 \text{ nH}}{0.57 \text{ m}\Omega \times 110 \text{ m}\Omega} = 35 \text{ nF}$$

It is best to have a dual location for  $C_{CS}$  in the layout so that standard values can be used in parallel to get as close to the desired value. For best accuracy,  $C_{CS}$  should be a 5% or 10% NPO capacitor. This example uses a 5% combination for  $C_{CS}$  of one 1.8 nF capacitor and one 1.5nF capacitor in parallel. Recalculating  $R_{CS}$  and  $R_{PH(X)}$  using this capacitor combination yields 108.8 k $\Omega$  and 62 k $\Omega$ . The closest standard 1% value for  $R_{PH(X)}$  is 61.9 k $\Omega$ .

When the inductor DCR is used as the sense element and copper wire is used as the source of the DCR, the user needs to compensate for temperature changes of the inductor's winding. Fortunately, copper has a well known temperature coefficient (TC) of 0.39%/°C.

If  $R_{CS}$  is designed to have an opposite and equal percentage change in resistance to that of the wire, it cancels the temperature variation of the inductor DCR. Due to the nonlinear nature of NTC thermistors, Resistor  $R_{CS1}$  and Resistor  $R_{CS2}$  are needed. See Figure 10 to linearize the NTC and produce the desired temperature tracking.

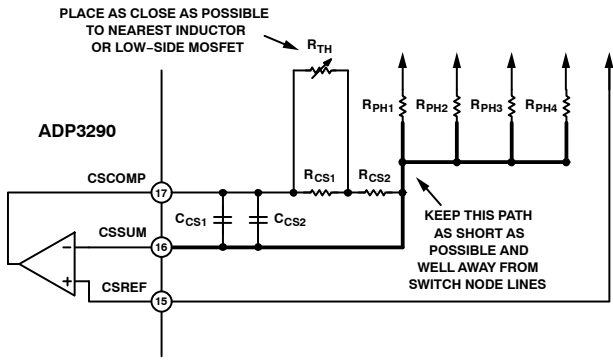

Figure 10. Temperature Compensation Circuit Values

The following procedure and equations yield values to use for  $R_{CS1}$ ,  $R_{CS2}$ , and  $R_{TH}$  (the thermistor value at 25°C) for a given  $R_{CS}$  value.

1. Select an NTC based on type and value. Because the value is unknown, use a thermistor with a value close to  $R_{CS}$ . The NTC should also have an initial tolerance of better than 5%.
2. Based on the type of NTC, find its relative resistance value at two temperatures. The temperatures that work well are 50°C and 90°C. These resistance values are called  $A$  ( $R_{TH(50^\circ C)}/R_{TH(25^\circ C)}$ ) and  $B$  ( $R_{TH(90^\circ C)}/R_{TH(25^\circ C)}$ ). The relative value of the NTC is always 1 at 25°C.
3. Find the relative value of  $R_{CS}$  required for each of these temperatures. This is based on the percentage change needed, which in this example is initially 0.39%/°C. These temperatures are called  $r_1$  ( $1/(1 + TC \times (T_1 - 25^\circ C))$ ) and  $r_2$  ( $1/(1 + TC \times (T_2 - 25^\circ C))$ ), where  $TC = 0.0039$  for copper,  $T_1 = 50^\circ C$ , and  $T_2 = 90^\circ C$ . From this,  $r_1 = 0.9112$  and  $r_2 = 0.7978$ .
4. Compute the relative values for  $R_{CS1}$ ,  $R_{CS2}$ , and  $R_{TH}$  using:

$$r_{CS2} = \frac{(A - B) \times r_1 \times r_2 - A \times (1 - B) \times r_2 + B \times (1 - A) \times r_1}{A \times (1 - B) \times r_1 - B \times (1 - A) \times r_2 - (A - B)} \quad (\text{eq. 8})$$

$$r_{CS1} = \frac{(1 - A)}{\frac{1}{1 - r_{CS2}} - \frac{A}{r_1 - r_{CS2}}} \quad (\text{eq. 9})$$

$$r_{TH} = \frac{1}{\frac{1}{1 - r_{CS2}} - \frac{1}{r_{CS1}}} \quad (\text{eq. 10})$$

Calculate  $R_{TH} = r_{TH} \times R_{CS}$ , then select the closest value of thermistor available. Also, compute a scaling factor ( $k$ ) based on the ratio of the actual thermistor value used relative to the computed one.

$$k = \frac{R_{TH(\text{ACTUAL})}}{R_{TH(\text{CALCULATED})}} \quad (\text{eq. 11})$$

5. Calculate values for  $R_{CS1}$  and  $R_{CS2}$  using Equation 12 and 13.

$$R_{CS1} = R_{CS} \times k \times r_{CS1} \quad (\text{eq. 12})$$

$$R_{CS2} = R_{CS} \times ((1 - k) + (k \times r_{CS2})) \quad (\text{eq. 13})$$

In this example,  $R_{CS}$  is calculated to be 114 kΩ. Look for an available 100 kΩ thermistor, 0603 size. One such thermistor is the Vishay NTHS0603N01N1003JR NTC thermistor with  $A = 0.3602$  and  $B = 0.09174$ . From these values,  $r_{CS1} = 0.3795$ ,  $r_{CS2} = 0.7195$ , and  $r_{TH} = 1.075$ .

Solving for  $R_{TH}$  yields 122.55 kΩ, so 100 kΩ is chosen, making  $k = 0.816$ . Next, find  $R_{CS1}$  and  $R_{CS2}$  to be 35.3 kΩ and 87.9 kΩ. Finally, choose the closest 1% resistor values, which yield a choice of 35.7 kΩ and 88.7 kΩ.

**Load Line Setting**

For load line values greater than 1 mΩ,  $R_{CSA}$  can be set equal to  $R_O$ , and the LLSET pin can be directly connected to the CSCOMP pin. When the load line value needs to be less than 1 mΩ, two additional resistors are required. Figure 11 shows the placement of these resistors.

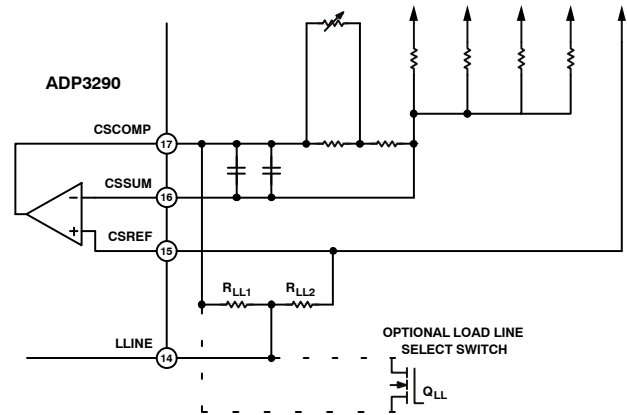

Figure 11. Load Line Setting Resistors

The two resistors  $R_{LL1}$  and  $R_{LL2}$  set up a divider between the CSCOMP pin and CSREF pin. This resistor divider is input into the LLSET pin to set the load line slope  $R_O$  of the VR according to the following equation:

$$R_O = \frac{R_{LL2}}{R_{LL1} + R_{LL2}} \times R_{CSA} \quad (\text{eq. 14})$$

The resistor values for  $R_{LL1}$  and  $R_{LL2}$  are limited by two factors.

- The minimum value is based upon the loading of the CSCOMP pin. This pin’s drive capability is 500 μA and the majority of this should be allocated to the CSA feedback. If the current through  $R_{LL1}$  and  $R_{LL2}$  is limited to 10% of this (50 μA), the following limit can be placed for the minimum value for  $R_{LL1}$  and  $R_{LL2}$ :

$$R_{LL1} + R_{LL2} \geq \frac{I_{LIM} \times R_{CSA}}{50 \times 10^{-6}} \quad (\text{eq. 15})$$

Here,  $I_{LIM}$  is the current limit current, which is the maximum signal level that the CSA responds to.

It is best to select the resistor values to minimize their values to reduce the noise and parasitic susceptibility of the feedback path.

By combining Equation 14 with Equation 15 and selecting minimum values for the resistors, the following equations result:

$$R_{LL2} = \frac{I_{LIM} \times R_O}{50 \mu A} \quad (\text{eq. 16})$$

$$R_{LL1} = \left( \frac{R_{CSA}}{R_O} - 1 \right) \times R_{LL2} \quad (\text{eq. 17})$$

Another useful feature for some VR applications is the ability to select different load lines. Figure 11 shows an optional MOSFET switch that allows this feature. Here, design for  $R_{CSA} = R_{O(MAX)}$  (selected with  $Q_{LL}$  on) and then use Equation 14 to set  $R_O = R_{O(MIN)}$  (selected with  $Q_{LL}$  off).

For this design,  $R_{CSA} = R_O = 1 \text{ m}\Omega$ . As a result, connect LLSET directly to CSCOMP; the  $R_{LL1}$  and  $R_{LL2}$  resistors are not needed.

### Output Offset

The Intel specification requires that at no load the nominal output voltage of the regulator be offset to a value lower than the nominal voltage corresponding to the VID code. The offset is set by a constant current source flowing out of the FB pin ( $I_{FB}$ ) and flowing through  $R_B$ . The value of  $R_B$  can be found using Equation 18.

$$R_B = \frac{V_{VID} - V_{ONL}}{I_{FB}} \quad (\text{eq. 18})$$

$$R_B = \frac{1.4 \text{ V} - 1.381 \text{ V}}{15 \mu A} = 1.27 \text{ k}\Omega$$

The closest standard 1% resistor value is 1.21 k $\Omega$ .

The required output decoupling for the regulator is typically recommended by Intel for various processors and platforms. Use some simple design guidelines to determine the requirements. These guidelines are based on having both bulk capacitors and ceramic capacitors in the system.

First, select the total amount of ceramic capacitance. This is based on the number and type of capacitor to be used. The best location for ceramic capacitors is inside the socket, with 12 to 18, 1206 size being the physical limit. Other capacitors can be placed along the outer edge of the socket as well.

To determine the minimum amount of ceramic capacitance required, start with a worst case load step occurring right after a switching cycle has stopped. The ceramic capacitance then delivers the charge to the load while the load is ramping up and until the VR has responded with the next switching cycle.

Equation 19 gives the designer a rough approximation for determining the minimum ceramic capacitance. Due to the complexity of the PCB parasitics and bulk capacitors, the actual amount of ceramic capacitance required can vary.

$$C_{Z(MIN)} \geq \frac{1}{R_O} \times \left[ \frac{1}{f_{SW}} \times \left( \frac{1}{n} - D \right) - \frac{\Delta I_O}{2 S_R} \right] \quad (\text{eq. 19})$$

The typical ceramic capacitors consist of multiple 10  $\mu\text{F}$  or 22  $\mu\text{F}$  capacitors. For this example, Equation 19 yields 180.8  $\mu\text{F}$ , so eighteen, 22  $\mu\text{F}$  ceramic capacitors suffice.

Next, there is an upper limit imposed on the total amount of bulk capacitance ( $C_X$ ) when the user considers the VID OTF voltage stepping of the output (voltage step  $V_V$  in time  $t_V$  with error of  $V_{ERR}$ ).

A lower limit is based on meeting the capacitance for load release for a given maximum load step ( $\Delta I_O$ ) and a maximum allowable overshoot. The total amount of load release voltage is given as  $\Delta V_O = \Delta I_O \times R_O + \Delta V_{ri}$ , where  $\Delta V_{ri}$  is the maximum allowable overshoot voltage.

$$C_{X(MAX)} \leq \frac{L}{nK^2 R^2 O} \times \frac{V_V}{V_{VID}} \times \left[ \sqrt{1 + \left( t_V \frac{V_{VID}}{V_V} \times \frac{nKR_O}{L} \right)^2} - 1 \right] - C_Z$$

where :  $K = -1n \left( \frac{V_{ERR}}{V_V} \right)$  (eq. 20)

To meet the conditions of these equations and transient response, the ESR of the bulk capacitor bank ( $R_X$ ) should be less than two times the droop resistance ( $R_O$ ). If the  $C_{X(MIN)}$  is larger than  $C_{X(MAX)}$ , the system cannot meet the VID OTF specification and can require the use of a smaller inductor or more phases (and may have to increase the switching frequency to keep the output ripple the same).

This example uses 18, 22  $\mu\text{F}$  1206 MLC capacitors ( $C_Z = 396 \mu\text{F}$ ). The VID OTF step change is 1.1V in 233.75  $\mu\text{s}$  with a settling error of 5 mV. The maximum allowable load release overshoot for this example is 50 mV, therefore, solving for the bulk capacitance yields.

$$C_{X(MIN)} \geq \left[ \frac{L \times \Delta I_O}{n \times \left( R_O + \frac{\Delta V_{rl}}{\Delta I_O} \right) \times V_{VID}} - C_Z \right] \quad (\text{eq. 21})$$

$$C_{X(MIN)} \geq \left[ \frac{220 \text{ nH} \times 95 \text{ A}}{4 \times \left( 1.0 \text{ m}\Omega + \frac{50 \text{ mV}}{95 \text{ A}} \right) \times 1.4 \text{ V}} - 396 \text{ }\mu\text{F} \right] = 2.08 \text{ mF} \quad (\text{eq. 22})$$

$$C_{X(MAX)} \leq \frac{220 \text{ nH} \times 1.1 \text{ V}}{4 \times 5.39^2 \times (1.0 \text{ m}\Omega)^2 \times 1.4 \text{ V}} \times \left[ \sqrt{1 + \left( \frac{233.75 \text{ }\mu\text{s} \times 1.4 \text{ V} \times 4 \times 5.39 \times 1.0 \text{ m}\Omega}{1.1 \text{ V} \times 220 \text{ nH}} \right)^2} - 1 \right] \quad (\text{eq. 23})$$

$$- 396 \text{ }\mu\text{F} = 41.5 \text{ mF}$$

where  $K = 5.39$ .

Using 8, 560  $\mu\text{F}$  Al-Poly capacitors with a typical ESR of 5  $\text{m}\Omega$  each yields  $C_X = 4.48 \text{ mF}$  with an  $R_X = 0.6 \text{ m}\Omega$ .

One last check should be made to ensure that the ESL of the bulk capacitors ( $L_X$ ) is low enough to limit the high frequency ringing during a load change.

This is tested using:

$$L_X \leq C_Z \times R_O^2 \times Q^2 \quad (\text{eq. 24})$$

$$L_Z \leq 396 \text{ }\mu\text{F} \times (1 \text{ m}\Omega)^2 \times \frac{4}{3} = 528 \text{ pH}$$

where  $Q^2$  is limited to 4/3 to ensure a critically damped system.

In this example,  $L_X$  is approximately 250 pH for the 8, Al-Poly capacitors, which satisfies this limitation. If the  $L_X$  of the chosen bulk capacitor bank is too large, the number of ceramic capacitors needs to be increased, or lower ESL bulks need to be used if there is excessive undershoot during a load transient.

For this multi-mode control technique, all ceramic designs can be used providing the conditions of Equation 19 through Equation 24 are satisfied.

### Power MOSFETs

For this example, the N-channel power MOSFETs have been selected for one high-side switch and two low-side switches per phase. The main selection parameters for the power MOSFETs are  $V_{GS(TH)}$ ,  $Q_G$ ,  $C_{ISS}$ ,  $C_{RSS}$ , and  $R_{DS(ON)}$ . The minimum gate drive voltage (the supply voltage to the ADP3120A dictates whether standard threshold or logic-level threshold MOSFETs must be used. With  $V_{GATE} \sim 10 \text{ V}$ , logic-level threshold MOSFETs ( $V_{GS(TH)} < 2.5 \text{ V}$ ) are recommended.

The maximum output current ( $I_O$ ) determines the  $R_{DS(ON)}$  requirement for the low-side (synchronous) MOSFETs. With the ADP3290, currents are balanced between phases, thus, the current in each low-side MOSFET is the output

current divided by the total number of MOSFETs ( $n_{SF}$ ). With conduction losses being dominant, Equation 25 shows the total power that is dissipated in each synchronous MOSFET in terms of the ripple current per phase ( $I_R$ ) and average total output current ( $I_O$ ).

$$P_{SF} = (1 - D) \times \left[ \left( \frac{I_O}{n_{SF}} \right)^2 + \frac{1}{12} \times \left( \frac{n I_R}{n_{SF}} \right)^2 \right] \times R_{DS(SF)} \quad (\text{eq. 25})$$

Knowing the maximum output current being designed for and the maximum allowed power dissipation, the user can find the required  $R_{DS(ON)}$  for the MOSFET. For D-PAK MOSFETs up to an ambient temperature of 50°C, a safe limit for  $P_{SF}$  is 1 W to 1.5 W at 120°C junction temperature. Thus, for this example (115 A maximum),  $R_{DS(SF)}$  (per MOSFET)  $< 8.5 \text{ m}\Omega$ . This  $R_{DS(SF)}$  is also at a junction temperature of about 120°C. As a result, users need to account for this when making this selection. This example uses two lower-side MOSFETs at 10.5  $\text{m}\Omega$ , each at 120°C.

Another important factor for the synchronous MOSFET is the input capacitance and feedback capacitance. The ratio of the feedback to input needs to be small (less than 10% is recommended) to prevent accidental turn-on of the synchronous MOSFETs when the switch node goes high.

Also, the time to switch the synchronous MOSFETs off should not exceed the non-overlap dead time of the MOSFET driver (40 ns typical for the ADP3120A). The output impedance of the driver is approximately 2  $\Omega$ , and the typical MOSFET input gate resistances are about 1  $\Omega$  to 2  $\Omega$ . Therefore, a total gate capacitance of less than 6000 pF should be adhered to. Because two MOSFETs are in parallel, the input capacitance for each synchronous MOSFET should be limited to 3000 pF.

The high-side (main) MOSFET has to be able to handle two main power dissipation components: conduction and switching losses. The switching loss is related to the amount

of time it takes for the main MOSFET to turn on and off, and to the current and voltage that are being switched. Basing the switching speed on the rise and fall time of the gate driver impedance and MOSFET input capacitance, Equation 26 provides an approximate value for the switching loss per main MOSFET, where  $n_{MF}$  is the total number of main MOSFETs.

$$P_{S(MF)} = 2 \times f_{SW} \times \frac{V_{CC} \times I_O}{n_{MF}} \times R_G \times \frac{n_{MF}}{n} \times C_{ISS} \quad (\text{eq. 26})$$

where  $R_G$  is the total gate resistance ( $2 \Omega$  for the ADP3120A and about  $1 \Omega$  for typical high speed switching MOSFETs, making  $R_G = 3 \Omega$ ), and  $C_{ISS}$  is the input capacitance of the main MOSFET. Adding more main MOSFETs ( $n_{MF}$ ) does not help the switching loss per MOSFET because the additional gate capacitance slows switching. Use lower gate capacitance devices to reduce switching loss.

The conduction loss of the main MOSFET is given by the following, where  $R_{DS(MF)}$  is the on resistance of the MOSFET:

$$P_{C(MF)} = D \times \left[ \left( \frac{I_O}{n_{MF}} \right)^2 + \frac{1}{12} \times \left( \frac{n \times I_R}{n_{MF}} \right)^2 \right] \times R_{DS(MF)} \quad (\text{eq. 27})$$

Typically, for main MOSFETs, the highest speed (low  $C_{ISS}$ ) device is preferred, but these usually have higher on resistance. Select a device that meets the total power dissipation (about 1.5 W for a single D-PAK) when combining the switching and conduction losses.

For this example, an BSC100N03L is selected as the main MOSFET (eight total;  $n_{MF} = 4$ ), with  $C_{ISS} = 1000$  pF (maximum) and  $R_{DS(MF)} = 11$  m $\Omega$  (maximum at  $T_J = 120^\circ\text{C}$ ). An IPD09N03L is selected as the synchronous MOSFET (eight total;  $n_{SF} = 8$ ), with  $C_{ISS} = 1600$  pF (maximum) and  $R_{DS(SF)} = 10.5$  m $\Omega$  (maximum at  $T_J = 120^\circ\text{C}$ ). The synchronous MOSFET  $C_{ISS}$  is less than 3000 pF, satisfying this requirement.

Solving for the power dissipation per MOSFET at  $I_O = 115$  A and  $I_R = 7.5$  A yields 1.9 W for each synchronous MOSFET and 2.0 W for each main MOSFET.

Finally, consider the power dissipation in the driver for each phase. This is best expressed as  $Q_G$  for the MOSFETs and is given by Equation 28, where  $Q_{GMF}$  is the total gate charge for each main MOSFET and  $Q_{GSF}$  is the total gate charge for each synchronous MOSFET.

$$P_{DRV} = \left[ \frac{f_{SW}}{2 \times n} \times (n_{MF} \times Q_{GMF} + n_{SF} \times Q_{GSF}) + I_{CC} \right] \times V_{CC} \quad (\text{eq. 28})$$

Also shown is the standby dissipation factor ( $I_{CC} \times V_{CC}$ ) of the driver. For the ADP3120A, the maximum dissipation should be less than 400 mW. In this example, with  $I_{CC} = 7$  mA,  $Q_{GMF} = 13$  nC, and  $Q_{GSF} = 15$  nC, there is 200 mW in each driver, which is below the 400 mW

dissipation limit. See the ADP3120A data sheet for more details.

### Ramp Resistor Selection

The ramp resistor ( $R_R$ ) is used for setting the size of the internal PWM ramp. The value of this resistor is chosen to provide the best combination of thermal balance, stability, and transient response. Equation 29 is used for determining the optimum value.

$$R_R = \frac{A_R \times L}{3 \times A_D \times R_{DS} \times C_R} \quad (\text{eq. 29})$$

$$R_R = \frac{0.5 \times 220 \text{ nH}}{3 \times 5 \times 4 \text{ m}\Omega \times 5 \text{ pF}} = 367 \text{ k}\Omega$$

where:

$A_R$  is the internal ramp amplifier gain.

$A_D$  is the current balancing amplifier gain.

$R_{DS}$  is the total low-side MOSFET on resistance.

$C_R$  is the internal ramp capacitor value.

Another requirement also needs to be satisfied:

$I_{RAMP} < I_{CLAMP}$  ( $200 \mu\text{A}/3$ ), thus:

$$R_R \geq \frac{A_R \times (V_{CC} - V_{VID})}{I_{CLAMP}} = \frac{0.5 \times (12 - 1.4) \text{ V}}{66.7 \mu\text{A}} = 79 \text{ k}\Omega \quad (\text{eq. 30})$$

Since above  $R_R$  value is bigger than 79 k $\Omega$ , it keeps the value of 267 k $\Omega$ .

The internal ramp voltage magnitude can be calculated by using:

$$V_R = \frac{A_R \times (1 - D) \times V_{VID}}{R_R \times C_R \times f_{SW}} \quad (\text{eq. 31})$$

$$V_R = \frac{0.5 \times (1 - 0.117) \times 1.4 \text{ V}}{367 \text{ k}\Omega \times 5 \text{ pF} \times 450 \text{ kHz}} = 748 \text{ mV}$$

The size of the internal ramp can be made larger or smaller. If it is made larger, stability and noise rejection improves, but transient degrades. Likewise, if the ramp is made smaller, transient response improves at the sacrifice of noise rejection and stability.

The factor of 3 in the denominator of Equation 29 sets a ramp size that gives an optimal balance for good stability, transient response, and thermal balance.

### Comp Pin Ramp

A ramp signal on the COMP pin is due to the droop voltage and output voltage ramps. This ramp amplitude adds to the internal ramp to produce the following overall ramp signal at the PWM input:

$$V_{RT} = \frac{V_R}{\left( 1 - \frac{2 \times (1 - n \times D)}{n \times f_{SW} \times C_X \times R_O} \right)} \quad (\text{eq. 32})$$

In this example, the overall ramp signal is 0.862 V. If the ramp size is smaller than 0.5 V, increase the ramp size to be at least 0.5 V by decreasing the ramp resistor for noise immunity.

### Current Limit Setpoint

To select the current limit setpoint, first find the resistor value for  $R_{LIM}$ . The current limit threshold for the ADP3290 is set with a constant current source ( $I_{LIM} = 4/3 * I_{REF}$ ) flowing out of the  $I_{LIM}$  pin, which sets up a voltage ( $V_{LIM}$ ) across  $R_{LIM}$ . Thus, increasing  $R_{LIM}$  now increases the current limit.  $R_{LIM}$  can be found using:

$$R_{LIM} = \frac{V_{LIM}}{I_{LIM}} = \frac{I_{LIM} \times R_{CS} \times DCR}{\frac{4}{3} \times V_{REF} \times R_{PH}} \times R_{REF} \quad (\text{eq. 33})$$

Here,  $I_{LIM}$  is the peak average current limit for the supply output. The peak average current is the dc current limit plus the output ripple current. In this example, choose  $I_{LIM\_DC} = 150$  A (130% \* TDC) and having a ripple current of 10 A gives an  $I_{LIM}$  of 160 A.  $R_{CS}$  is selected as 110 k $\Omega$  in this example,  $R_{PH}$  is 68.1 k $\Omega$ , DCR is 0.57 m $\Omega$  (Delta THCBR1290–221–R). This results in an  $R_{LIM} = 7.4$  k $\Omega$ , for which 7.5 k $\Omega$  is chosen as the nearest 1% value.

The per-phase initial duty cycle limit and peak current during a load step are determined by:

$$D_{MAX} = D \times \frac{V_{COMP(MAX)} - V_{BIAS}}{V_{RT}} \quad (\text{eq. 34})$$

$$I_{PHMAX} = \frac{D_{MAX}}{f_{SW}} \times \frac{(V_{IN} - V_{VID})}{L} \quad (\text{eq. 35})$$

For the ADP3290, the maximum COMP voltage ( $V_{COMP(MAX)}$ ) is 4.4 V and the COMP pin bias voltage ( $V_{BIAS}$ ) is 1.2 V. In this example, the maximum duty cycle is 0.433 and the peak current is 46.4 A.

The limit of the peak per-phase current described earlier during the secondary current limit is determined by:

$$I_{PHLIM} = \frac{V_{COMP(CLAMPED)} - V_{BIAS}}{A_D \times R_{DS(MAX)}} \quad (\text{eq. 36})$$

For the ADP3290, the current balancing amplifier gain ( $A_D$ ) is 5 and the clamped COMP pin voltage is 3.3 V. Using an  $R_{DS(MAX)}$  of 4.5 m $\Omega$  (low-side on resistance at 150°C) results in a per-phase peak current limit of 93.3 A. This current level can be reached only with an absolute short at the output, and the current limit latchoff function shuts down the regulator before overheating can occur.

First, compute the time constants for all the poles and zeros in the system using Equation 38 to Equation 42.

$$R_E = n \times R_O + A_D \times R_{DS} + \frac{R_L \times V_{RT}}{V_{VID}} + \frac{2 \times L \times (1 - n \times D) \times V_{RT}}{n \times C_X \times R_O \times V_{VID}}$$

$$R_E = 4 \times 1 \text{ m}\Omega + 5 \times 5.25 \text{ m}\Omega + \frac{0.57 \text{ m}\Omega \times 0.862 \text{ V}}{1.4 \text{ V}} + \frac{2 \times 220 \text{ nH} \times (1 - 0.467) \times 0.862 \text{ V}}{4 \times 4.48 \text{ mF} \times 1 \text{ m}\Omega \times 1.4 \text{ V}} = 38.7 \text{ m}\Omega \quad (\text{eq. 38})$$

$$T_A = C_X \times (R_O - R^1) + \frac{L_X}{R_O} \times \frac{R_O - R^1}{R_X} = 4.48 \text{ mF} \times (1 \text{ m}\Omega - 0.5 \text{ m}\Omega) + \frac{250 \text{ pH}}{1 \text{ m}\Omega} \times \frac{1 \text{ m}\Omega - 0.5 \text{ m}\Omega}{0.6 \text{ m}\Omega} = 2.45 \text{ }\mu\text{s} \quad (\text{eq. 39})$$

$$T_B = (R_X + R^1 - R_O) \times C_X = (0.6 \text{ m}\Omega + 0.5 \text{ m}\Omega - 1 \text{ m}\Omega) \times 4.48 \text{ mF} = 448 \text{ ns} \quad (\text{eq. 40})$$

### $I_{MON}$ Setpoint

According to the function definition,  $I_{MON}$  output voltage should represent the load condition within the whole load current range. The formula below will result  $R_{IMON}$  in need:

$$R_{IMON} = \frac{V_{IMON}}{I_{IMON}} = \frac{V_{IMON} \times R_{LIM}}{M \times R_O \times I_L} \quad (\text{eq. 37})$$

Here,  $I_L$  is the total load current,  $M = 10$  is the current gain for  $I_{MON}$ . Since  $I_{MON}$  output clamp voltage is around 1.1 V,  $V_{IMON}$  is selected as 0.8V when  $I_L = I_{MAX}$  (130A). While  $R_{LIM} = 7.5$  k $\Omega$ ,  $R_{IMON}$  is calculated as 5 k $\Omega$ , for which 4.99 k $\Omega$  is chosen as the nearest 1% value.

There is a capacitor ( $C_{IMON}$ ) in parallel with  $R_{IMON}$ , in order to filter output current ripple. The time constant of  $R_{IMON} * C_{IMON}$  should be much bigger ( $> 10 \times$ ) than circuit switching period. In this example,  $C_{IMON}$  is selected as 0.1  $\mu$ F.

### Feedback Loop Compensation Design

Optimized compensation of the ADP3290 allows the best possible response of the regulator output to a load change. The basis for determining the optimum compensation is to make the regulator and output decoupling appear as an output impedance that is entirely resistive over the widest possible frequency range, including dc, and equal to the droop resistance ( $R_O$ ). With the resistive output impedance, the output voltage droops in proportion to the load current at any load current slew rate. This ensures optimal positioning and minimizes the output decoupling.

Because of the multi-mode feedback structure of the ADP3290, the feedback compensation must be set to make the converter output impedance work in parallel with the output decoupling to make the load look entirely resistive. Compensation is needed for several poles and zeros created by the output inductor and the decoupling capacitors (output filter).

A type-three compensator on the voltage feedback is adequate for proper compensation of the output filter. Equation 38 to Equation 42 are intended to yield an optimal starting point for the design; some adjustments may be necessary to account for PCB and component parasitic effects (see the Tuning the ADP3290 section).



$$T_C = \frac{V_{RT} \times \left( L - \frac{A_D \times R_{DS}}{2 \times f_{SW}} \right)}{V_{VID} \times R_E} = \frac{0.862 \text{ V} \times \left( 220 \text{ nH} - \frac{5 \times 5.25 \text{ m}\Omega}{2 \times 450 \text{ kHz}} \right)}{1.4 \text{ V} \times 38.7 \text{ m}\Omega} = 3.04 \mu\text{s} \quad (\text{eq. 41})$$

$$T_D = \frac{C_X \times C_Z \times R_O^2}{C_X \times (R_O - R') + C_Z \times R_O} = \frac{4.48 \text{ mF} \times 396 \mu\text{F} \times (1 \text{ m}\Omega)^2}{4.48 \text{ mF} \times (1 \text{ m}\Omega - 0.5 \text{ m}\Omega) + 396 \mu\text{F} \times 1 \text{ m}\Omega} = 673 \text{ ns} \quad (\text{eq. 42})$$

where:

R' is the PCB resistance from the bulk capacitors to the ceramics.

R<sub>DS</sub> is the total low-side MOSFET on resistance per phase.

In this example, A<sub>D</sub> is 5, V<sub>RT</sub> equals 0.862 V, R' is approximately 0.5 mΩ (assuming a 4-layer, 1 ounce motherboard), and L<sub>X</sub> is 250 pH for the 8 Al-Poly capacitors.

The compensation values can then be solved using:

$$C_A = \frac{n \times R_O \times T_A}{R_E \times R_B} = \frac{4 \times 1 \text{ m}\Omega \times 2.45 \mu\text{s}}{38.7 \text{ m}\Omega \times 1.21 \text{ k}\Omega} \times 209 \text{ pF} \quad (\text{eq. 43})$$

$$R_A = \frac{T_C}{C_A} = \frac{3.04 \mu\text{s}}{209 \text{ pF}} = 14.5 \text{ k}\Omega \quad (\text{eq. 44})$$

$$C_B = \frac{T_B}{R_B} = \frac{448 \text{ ns}}{1.21 \text{ k}\Omega} = 370 \text{ pF} \quad (\text{eq. 45})$$

$$C_{FB} = \frac{T_D}{R_A} = \frac{673 \text{ ns}}{14.5 \text{ k}\Omega} = 46.4 \text{ pF} \quad (\text{eq. 46})$$

These are the starting values prior to tuning the design that account for layout and other parasitic effects (see the Tuning the ADP3290 section). The final values selected after tuning are:

$$C_A = 120 \text{ pF}$$

$$R_A = 28 \text{ k}\Omega$$

$$C_B = 120 \text{ pF}$$

$$C_{FB} = 3.3 \text{ pF}$$

Figure 12 and Figure 13 show the typical transient response using these compensation values.

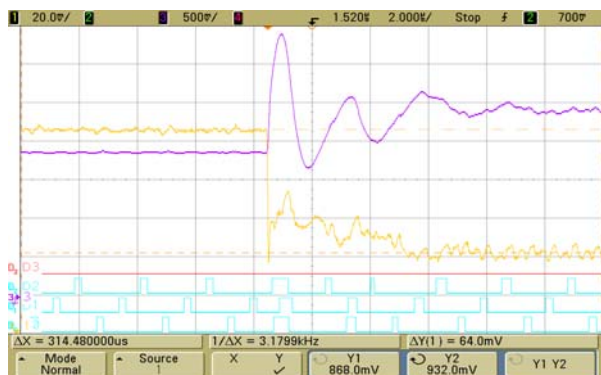

Figure 12. Typical Transient Response for Design Example Load Step



Figure 13. Typical Transient Response for Design Example Load Release  
1-V<sub>O</sub>, 3-COMP, 4-TRDET, D0~D2-PWM1~3

#### C<sub>IN</sub> Selection and Input Current di/dt Reduction

In continuous inductor current mode, the source current of the high-side MOSFET is approximately a square wave with a duty ratio equal to n × V<sub>OUT</sub>/V<sub>IN</sub> and an amplitude of one-nth the maximum output current. To prevent large voltage transients, a low ESR input capacitor, sized for the maximum rms current, must be used. The maximum rms capacitor current is given by:

$$I_{CRMS} = D \times I_O \times \sqrt{\frac{1}{N \times D} - 1} \quad (\text{eq. 47})$$

$$I_{CRMS} = 0.117 \times 115 \text{ A} \times \sqrt{\frac{1}{4 \times 0.117} - 1} = 14.3 \text{ A}$$

The capacitor manufacturer's ripple-current ratings are often based on only 2000 hours of life. As a result, it is advisable to further derate the capacitor or to choose a capacitor rated at a higher temperature than required. Several capacitors can be placed in parallel to meet size or height requirements in the design. In this example, the input capacitor bank is formed by three 680 μF, 16 V aluminum electrolytic capacitors and twelve 4.7 μF ceramic capacitors.

To reduce the input current di/dt to a level below the recommended maximum of 0.1 A/μs, an additional small inductor (L > 370 nH at 18 A) should be inserted between the converter and the supply bus. This inductor also acts as a filter between the converter and the primary power source.

**Thermal Monitor Design**

The thermistor is used on the TTSENSE input of the ADP3290 for monitoring the temperature of the VR. A constant current of 123  $\mu$ A is sourced out of this pin and runs through a thermistor network such as the one shown in Figure 14.

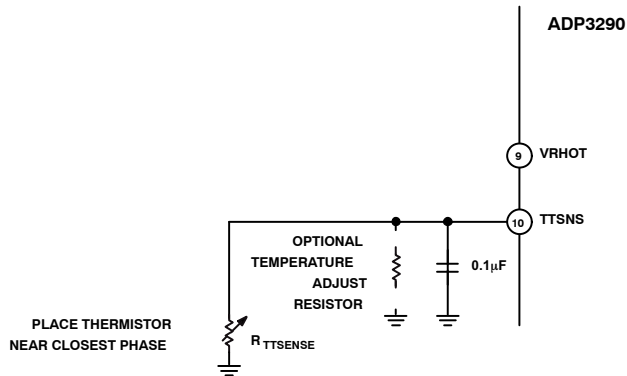

**Figure 14. VR Thermal Monitor Circuit**

A voltage is generated from this current through the thermistor and sensed inside the IC. When the voltage reaches 1.105V, the VRFAN output gets set. When the voltage reaches 0.81 V, the VRHOT gets set. This corresponds to

$R_{TTSENSE}$  values of 8.98 k $\Omega$  for VRFAN and 6.58 k $\Omega$  for VRHOT.

These values correspond to a thermistor temperature of  $\sim$ 100 $^{\circ}$ C and  $\sim$ 110 $^{\circ}$ C when using the same type of 100 k $\Omega$  NTC thermistor used in the current sense amplifier.

An additional fixed resistor in parallel with the thermistor allows tuning of the trip point temperatures to match the hottest temperature in the VR, when the thermistor itself is directly sensing a proportionately lower temperature. Setting this resistor value is best accomplished with a variable resistor during thermal validation and then fixing this value for the final design.

Additionally, a 0.1  $\mu$ F capacitor should be used for filtering noise.

**Shunt Resistor Design**

The ADP3290 uses a shunt to generate 5.0 V from the 12 V supply range. A trade off can be made between the power dissipated in the shunt resistor and the UVLO threshold. Figure 15 shows the typical resistor value needed to realize certain UVLO voltages. It also gives the maximum power dissipated in the shunt resistor for these UVLO voltages.

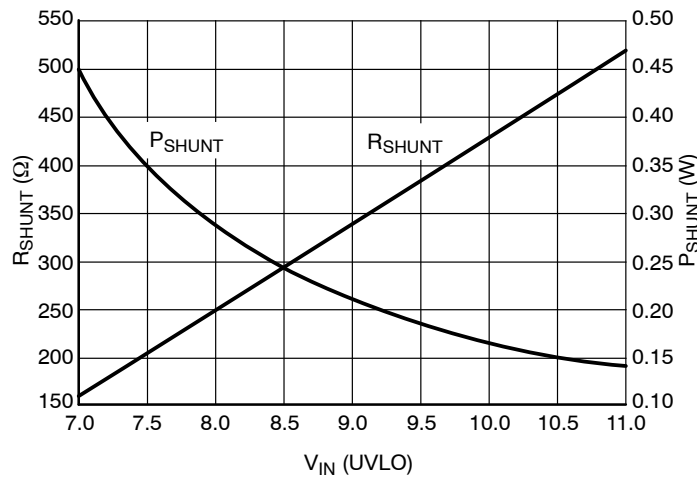

**Figure 15. Typical Shunt Resistor Value and Power Dissipation for Different UVLO Voltage**

The maximum power dissipated is calculated using Equation 48.

$$P_{MAX} = \frac{(V_{IN(MAX)} - V_{CC(MIN)})^2}{R_{SHUNT}} \quad (\text{eq. 48})$$

where:

$V_{IN(MAX)}$  is the maximum voltage from the 12 V input supply (if the 12 V input supply is 12 V  $\pm$  5%,  $V_{IN(MAX)}$  = 12.6 V; if the 12 V input supply is 12 V  $\pm$  10%,  $V_{IN(MAX)}$  = 13.2 V).  $V_{CC(MIN)}$  is the minimum  $V_{CC}$  voltage of the ADP3290. This is specified as 4.75 V.  $R_{SHUNT}$  is the shunt resistor value.

The CECC standard specification for power rating in surface mount resistors is: 0603 = 0.1 W, 0805 = 0.125 W, 1206 = 0.25 W.

**Tuning the ADP3290**

1. Build a circuit based on the compensation values computed from the design spreadsheet.
2. Hook up the dc load to the circuit, turn it on, and verify its operation. Also, check for jitter at no load and full load.

**DC Load Line Setting**

3. Measure the output voltage at no load ( $V_{NL}$ ). Verify that it is within tolerance.
4. Measure the output voltage at full load cold ( $V_{FLCOLD}$ ). Let the board sit for ~10 minutes at full load, and then measure the output ( $V_{FLHOT}$ ). If there is a change of more than a few mV, adjust  $R_{CS1}$  and  $R_{CS2}$  using Equation 49 and Equation 51.

$$R_{CS2(NEW)} = R_{CS2(OLD)} \times \frac{V_{NL} - V_{FLCOLD}}{V_{NL} - V_{FLHOT}} \quad (\text{eq. 49})$$

5. Repeat Step 4 until the cold and hot voltage measurements remain the same.
6. Measure the output voltage from no load to full load using 5 A steps. Compute the load line slope

$$R_{CS1(NEW)} = \frac{1}{\frac{R_{CS1(OLD)} + R_{TH(25^\circ\text{C})}}{R_{CS1(OLD)} \times R_{TH(25^\circ\text{C})} + (R_{CS1(OLD)} - R_{CS1(NEW)}) \times (R_{CS1(OLD)} - R_{TH(25^\circ\text{C})})} - \frac{1}{R_{TH(25^\circ\text{C})}}} \quad (\text{eq. 51})$$

**AC Load Line Setting**

11. Remove the dc load from the circuit and hook up the dynamic load.
12. Hook up the scope to the output voltage and set it to dc coupling with the time scale at 100  $\mu\text{s}/\text{div}$ .
13. Set the dynamic load for a transient step of about 40 A at 1 kHz with 50% duty cycle.
14. Measure the output waveform (use dc offset on scope to see the waveform). Try to use a vertical scale of 100 mV/div or finer. This waveform should look similar to Figure 16.

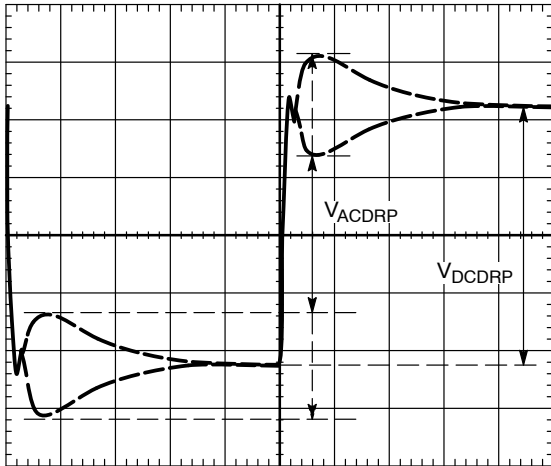

**Figure 16. AC Load Line Waveform**

15. Use the horizontal cursors to measure  $V_{ACDRP}$  and  $V_{DCDRP}$  as shown in Figure 16. Do not measure the undershoot or overshoot that happens immediately after this step.
16. If  $V_{ACDRP}$  and  $V_{DCDRP}$  are different by more than a few millivolts, use Equation 51 to adjust  $C_{CS}$ . Users may need to parallel different values to get the right one because limited standard capacitor

for each change, and then average to get the overall load line slope ( $R_{OMEAS}$ ).

7. If  $R_{OMEAS}$  is off from  $R_O$  by more than 0.05 m $\Omega$ , use Equation 50 to adjust the  $R_{PH}$  values.

$$R_{CS2(NEW)} = R_{CS2(OLD)} \times \frac{R_{OMEAS}}{R_O} \quad (\text{eq. 50})$$

8. Repeat Step 6 and Step 7 to check the load line. Repeat adjustments if necessary.
9. When the dc load line adjustment is complete, do not change  $R_{PH}$ ,  $R_{CS1}$ ,  $R_{CS2}$ , or  $R_{TH}$  for the remainder of the procedure.
10. Measure the output ripple at no load and full load with a scope, and make sure it is within specifications.

values are available. It is a good idea to have locations for two capacitors in the layout for this.

$$R_{CS(NEW)} = R_{CS(OLD)} \times \frac{V_{ACDRP}}{V_{DCDRP}} \quad (\text{eq. 52})$$

17. Repeat Step 11 to Step 13 and repeat the adjustments, if necessary. Once complete, do not change  $C_{CS}$  for the remainder of the procedure. Set the dynamic load step to maximum step size. Do not use a step size larger than needed. Verify that the output waveform is square, which means that  $V_{ACDRP}$  and  $V_{DCDRP}$  are equal.

**Initial Transient Setting**

18. With the dynamic load still set at the maximum step size, expand the scope time scale to either 2  $\mu\text{s}/\text{div}$  or 5  $\mu\text{s}/\text{div}$ . The waveform can have two overshoots and one minor undershoot (see Figure 17). Here,  $V_{DROOP}$  is the final desired value.

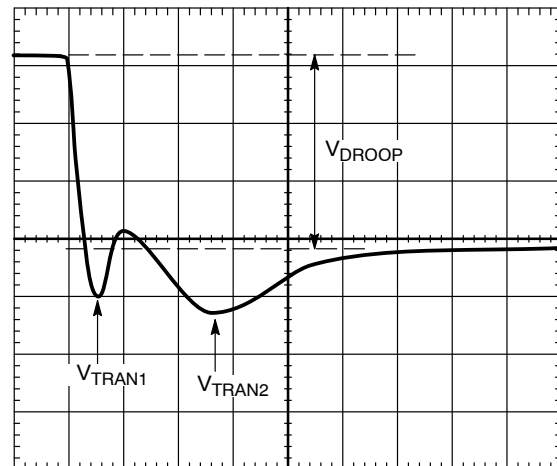

**Figure 17. Transient Setting Waveform**

19. If both overshoots are larger than desired, try making the adjustments using the following suggestions:
- Make the ramp resistor larger by 25% ( $R_{RAMP}$ )
  - For  $V_{TRAN1}$ , increase  $C_B$  or increase the switching frequency
  - For  $V_{TRAN2}$ , increase  $R_A$  and decrease  $C_A$  by 25%
- If these adjustments do not change the response, the design is limited by the output decoupling. Check the output response every time a change is made, and check the switching nodes to ensure that the response is still stable.
20. For load release (see Figure 18), if  $V_{TRANREL}$  is larger than the allowed overshoot, there is not enough output capacitance. Either more capacitance is needed, or the inductor values need to be made smaller. When changing inductors, start the design again using a spreadsheet and this tuning procedure.

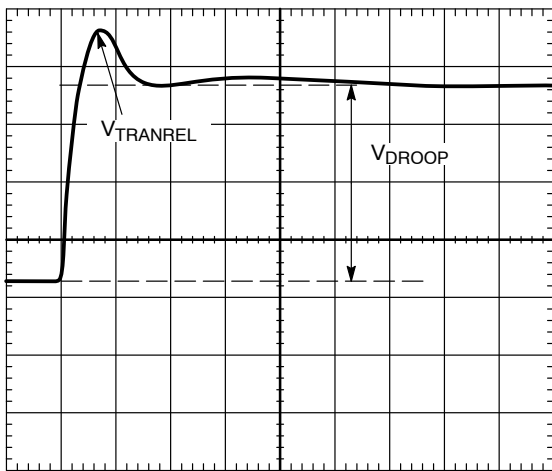

**Figure 18. Transient Setting Waveform**

Because the ADP3290 turns off all of the phases (switches inductors to ground), no ripple voltage is present during load release. Therefore, the user does not have to add headroom for ripple. This allows load release  $V_{TRANREL}$  to be larger than  $V_{TRAN1}$  by the amount of ripple, and still meet specifications.

If  $V_{TRAN1}$  and  $V_{TRANREL}$  are less than the desired final droop, this implies that capacitors can be removed. When removing capacitors, also check the output ripple voltage to make sure it is still within specifications.

### Layout and Component Placement

The following guidelines are recommended for optimal performance of a switching regulator in a PC system.

#### General Requirements

For good results, a PCB with at least four layers is recommended. This provides the needed versatility for control circuitry interconnections with optimal placement, power planes for ground, input and output power, and wide

interconnection traces in the remainder of the power delivery current paths. Keep in mind that each square unit of 1 ounce copper trace has a resistance of  $\sim 0.53 \text{ m}\Omega$  at room temperature.

Whenever high currents must be routed between PCB layers, use vias liberally to create several parallel current paths, so the resistance and inductance introduced by these current paths is minimized and the via current rating is not exceeded.

If critical signal lines (including the output voltage sense lines of the ADP3290) must cross through power circuitry, it is best to interpose a signal ground plane between those signal lines and the traces of the power circuitry. This serves as a shield to minimize noise injection into the signals at the expense of making signal ground a bit noisier.

An analog ground plane should be used around and under the ADP3290 as a reference for the components associated with the controller. This plane should be tied to the nearest output decoupling capacitor ground and should not be tied to any other power circuitry to prevent power currents from flowing into it.

The components around the ADP3290 should be located close to the controller with short traces. The most important traces to keep short and away from other traces are the FB pin and CSSUM pin. The output capacitors should be connected as close as possible to the load (or connector), for example, a microprocessor core, that receives the power. If the load is distributed, the capacitors should also be distributed and generally be in proportion to where the load tends to be more dynamic.

Avoid crossing any signal lines over the switching power path loop described in the Power Circuitry Recommendations sections.

#### Power Circuitry Recommendations

The switching power path should be routed on the PCB to encompass the shortest possible length to minimize radiated switching noise energy (EMI) and conduction losses in the board. Failure to take proper precautions often results in EMI problems for the entire PC system and noise-related operational problems in the power converter control circuitry. The switching power path is the loop formed by the current path through the input capacitors and the power MOSFETs, including all interconnecting PCB traces and planes. Using short and wide interconnection traces is especially critical in this path for two reasons: it minimizes the inductance in the switching loop, which can cause high energy ringing; and it accommodates the high current demand with minimal voltage loss.

When a power dissipating component, for example, a power MOSFET, is soldered to a PCB, it is recommended to liberally use the vias, both directly on the mounting pad and immediately surrounding it. Two important reasons for this are improved current rating through the vias and improved thermal performance from vias extended to the opposite side of the PCB, where a plane can more readily transfer the heat

## ADP3290

to the air. Make a mirror image of any pad being used to heatsink the MOSFETs on the opposite side of the PCB to achieve the best thermal dissipation in the air around the board. To further improve thermal performance, use the largest possible pad area.

The output power path should also be routed to encompass a short distance. The output power path is formed by the current path through the inductor, the output capacitors, and the load.

For best EMI containment, a solid power ground plane should be used as one of the inner layers extending fully under all the power components.

### Signal Circuitry Recommendations

The output voltage is sensed and regulated between the FB pin and the FBRTN pin, which connect to the signal ground at the load. To avoid differential mode noise pickup in the sensed signal, the loop area should be small. Thus, the FB trace and FBRTN trace should be routed adjacent to each other on top of the power ground plane back to the controller.

The feedback traces from the switch nodes should be connected as close as possible to the inductor. The CSREF signal should be connected to the output voltage at the nearest inductor to the controller.





**onsemi**, **Onsemi**, and other names, marks, and brands are registered and/or common law trademarks of Semiconductor Components Industries, LLC dba "**onsemi**" or its affiliates and/or subsidiaries in the United States and/or other countries. **onsemi** owns the rights to a number of patents, trademarks, copyrights, trade secrets, and other intellectual property. A listing of **onsemi**'s product/patent coverage may be accessed at [www.onsemi.com/site/pdf/Patent-Marking.pdf](http://www.onsemi.com/site/pdf/Patent-Marking.pdf). **onsemi** reserves the right to make changes at any time to any products or information herein, without notice. The information herein is provided "as-is" and **onsemi** makes no warranty, representation or guarantee regarding the accuracy of the information, product features, availability, functionality, or suitability of its products for any particular purpose, nor does **onsemi** assume any liability arising out of the application or use of any product or circuit, and specifically disclaims any and all liability, including without limitation special, consequential or incidental damages. Buyer is responsible for its products and applications using **onsemi** products, including compliance with all laws, regulations and safety requirements or standards, regardless of any support or applications information provided by **onsemi**. "Typical" parameters which may be provided in **onsemi** data sheets and/or specifications can and do vary in different applications and actual performance may vary over time. All operating parameters, including "Typicals" must be validated for each customer application by customer's technical experts. **onsemi** does not convey any license under any of its intellectual property rights nor the rights of others. **onsemi** products are not designed, intended, or authorized for use as a critical component in life support systems or any FDA Class 3 medical devices or medical devices with a same or similar classification in a foreign jurisdiction or any devices intended for implantation in the human body. Should Buyer purchase or use **onsemi** products for any such unintended or unauthorized application, Buyer shall indemnify and hold **onsemi** and its officers, employees, subsidiaries, affiliates, and distributors harmless against all claims, costs, damages, and expenses, and reasonable attorney fees arising out of, directly or indirectly, any claim of personal injury or death associated with such unintended or unauthorized use, even if such claim alleges that **onsemi** was negligent regarding the design or manufacture of the part. **onsemi** is an Equal Opportunity/Affirmative Action Employer. This literature is subject to all applicable copyright laws and is not for resale in any manner.

## PUBLICATION ORDERING INFORMATION

### LITERATURE FULFILLMENT:

Email Requests to: [orderlit@onsemi.com](mailto:orderlit@onsemi.com)

**onsemi Website:** [www.onsemi.com](http://www.onsemi.com)

### TECHNICAL SUPPORT

**North American Technical Support:**  
Voice Mail: 1 800-282-9855 Toll Free USA/Canada  
Phone: 011 421 33 790 2910

**Europe, Middle East and Africa Technical Support:**

Phone: 00421 33 790 2910

For additional information, please contact your local Sales Representative