

TLV3604, TLV3605 800-ps High-Speed RRI Comparator with LVDS Outputs

1 Features

- Low propagation delay: 800 ps
- Low overdrive dispersion: 350 ps
- Quiescent current: 12.1 mA
- High toggle frequency: 1.5 GHz / 3.0 Gbps
- Narrow pulse width detection capability: 600 ps
- LVDS output
- Supply range: 2.4 V to 5.5 V
- Input common-mode range extends 200 mV beyond both rails
- Low input offset voltage: ± 5 mV
- Packages: 6-Pin SC70, 12-Pin QFN (3 mm \times 3 mm)

2 Applications

- [Distance sensing in LIDAR](#)
- [Time-of-Flight sensors](#)
- [High speed trigger function in oscilloscope and logic analyzer](#)
- [High speed differential line receiver](#)
- [Drone vision](#)

3 Description

The TLV3604 and TLV3605 are 800-ps, high-speed comparators with LVDS outputs and rail-to-rail inputs. These features, along with an operating voltage range of 2.4 V to 5.5 V and a high toggle frequency of 3 Gbps, make the TLV3604 and TLV3605 well suited for LIDAR, clock and data recovery applications, and test and measurement systems.

Likewise, the TLV3604 and TLV3605 have strong input overdrive performance of 350 ps and are able

to detect narrow pulse widths of just 600 ps. This combination of low variation in propagation delay due to input overdrive and the ability to detect narrow pulses improve system performance and extend distance range in Time-of-Flight (ToF) applications.

The Low-Voltage-Differential-Signal (LVDS) output of the TLV3604 and TLV3605 also helps increase data throughput and optimizes power consumption. The complementary outputs reduce EMI by suppressing common mode noise on each output. The LVDS output is designed to drive and interface directly with downstream devices that accept a standard LVDS input, such as high-speed FPGAs and CPUs.

The TLV3604 is in a tiny 6 pin SC-70 package, which makes it easier for space sensitive applications such as an optical sensor module. The TLV3605 maintains the same performance as the TLV3604, and offers adjustable hysteresis control, shutdown, and latching features in a 12 pin QFN package making it an excellent choice for test and measurement applications.

Device Information

PART NUMBER	PACKAGE ⁽¹⁾	BODY SIZE (NOM)
TLV3604	SC70 (6)	1.25 mm \times 2.00 mm
TLV3605	QFN (12)	3.00 mm \times 3.00 mm

1. For all orderable packages, see the orderable addendum at the end of the datasheet.

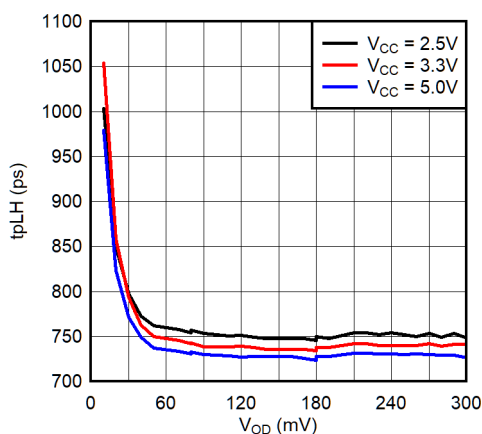

tpLH v. Overdrive Dispersion

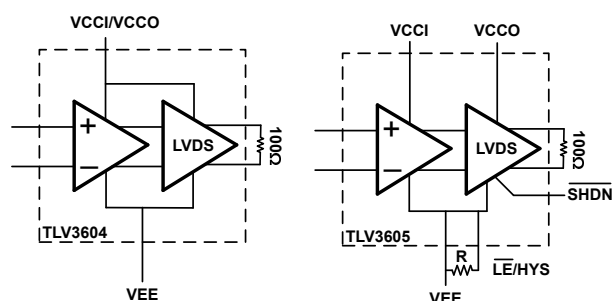

Functional Block Diagram



Table of Contents

1 Features	1	7.4 Device Functional Modes.....	12
2 Applications	1	8 Application and Implementation	13
3 Description	1	8.1 Application Information.....	13
4 Revision History	2	8.2 Typical Application.....	15
5 Pin Configuration and Functions	3	9 Power Supply Recommendations	18
Pin Functions.....	3	10 Layout	19
6 Specifications	4	10.1 Layout Guidelines.....	19
6.1 Absolute Maximum Ratings	4	10.2 Layout Example.....	19
6.2 ESD Ratings	4	11 Device and Documentation Support	21
6.3 Recommended Operating Conditions	4	11.1 Device Support.....	21
6.4 Thermal Information	5	11.2 Receiving Notification of Documentation Updates..	21
6.5 Electrical Characteristics ($V_{CCI} = V_{CCO} = 2.5\text{ V to}$ 5 V)	6	11.3 Support Resources.....	21
6.6 Typical Characteristics.....	8	11.4 Trademarks.....	21
7 Detailed Description	12	11.5 Electrostatic Discharge Caution.....	21
7.1 Overview.....	12	11.6 Glossary.....	21
7.2 Functional Block Diagram.....	12	12 Mechanical, Packaging, and Orderable Information	21
7.3 Feature Description.....	12		

4 Revision History

NOTE: Page numbers for previous revisions may differ from page numbers in the current version.

Changes from Revision C (April 2021) to Revision D (June 2021)	Page
• Update Hysteresis Curve.....	14

Changes from Revision B (December 2020) to Revision C (April 2021)	Page
• Updated Typical Performance Curves.....	8
• Updated Latch Functionality.....	13

Changes from Revision A (August 2020) to Revision B (December 2020)	Page
• APL to RTM release.....	1

5 Pin Configuration and Functions

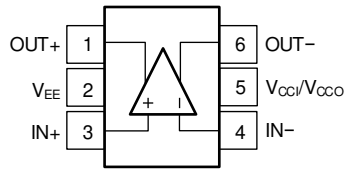

**Figure 5-1. DCK Package
6-Pin SC70
Top View**

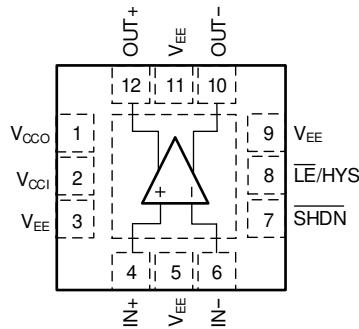

**Figure 5-2. RVK Package
12-Pin QFN
Top View**

Pin Functions

NAME	PIN		I/O	DESCRIPTION
	TLV3604	TLV3605		
IN+	3	4	I	Non-inverting input
IN-	4	6	I	Inverting input
OUT+	1	12	O	Non-inverting output
OUT-	6	10	O	Inverting output
V _{EE}	2	3, 5, 9, 11	I	Negative power supply
V _{CCI}	5	2	I	Positive input section power supply
V _{CCO}	5	1	I	Positive output section power supply
SHDN	-	7	I	Shutdown control, active low
LE/HYS	-	8	I	Adjustable hysteresis control and latch

6 Specifications

6.1 Absolute Maximum Ratings

over operating free-air temperature range (unless otherwise noted)⁽¹⁾

	MIN	MAX	UNIT
Input Supply Voltage: $V_{CCI} - V_{EE}$	-0.3	6	V
Output Supply Voltage: $V_{CCO} - V_{EE}$	-0.3	6	V
Supply Voltage Difference: $V_{CCI} - V_{CCO}$	-6	6	V
Input Voltage (IN+, IN-) ⁽²⁾	$V_{EE} - 0.3$	$V_{CCI} + 0.3$	V
Differential Input Voltage ($V_{DI} = IN+, IN-$)	$-(V_{CCI} + 0.3)$	$+(V_{CCI} + 0.3)$	V
Output Voltage (OUT+, OUT-) ⁽³⁾	$V_{EE} - 0.3$	$V_{CCO} + 0.3$	V
Shutdown Enable (\overline{SHDN})	$V_{EE} - 0.3$	$V_{CCO} + 0.3$	V
Latch and Hysteresis Control (\overline{LE}/HYS)	$V_{EE} - 0.3$	$V_{CCO} + 0.3$	V
Current into Input pins (IN+, IN-, \overline{SHDN} , \overline{LE}/HYS) ⁽²⁾	-10	+10	mA
Current into Output pins (OUT+, OUT-) ⁽³⁾	-10	+10	mA
Junction temperature, T_J		150	°C
Storage temperature, T_{stg}	-65	150	°C

- Operation outside the Absolute Maximum Ratings may cause permanent device damage. Absolute Maximum Ratings do not imply functional operation of the device at these or any other conditions beyond those listed under Recommended Operating Conditions. If used outside the Recommended Operating Conditions but within the Absolute Maximum Ratings, the device may not be fully functional, and this may affect device reliability, functionality, performance, and shorten the device lifetime.
- Input terminals are diode-clamped to the power-supply rails. Input signals that can swing more than 0.3 V beyond the supply rails or 6 V, whichever is lower, must be current-limited to 10 mA or less.
- Output terminals are diode-clamped to the power-supply rails. Output signals that can swing more than 0.3 V beyond the supply rails must be current-limited to 10 mA or less.

6.2 ESD Ratings

		VALUE	UNIT
$V_{(ESD)}$	Electrostatic discharge	TLV3604 Human-body model (HBM), per ANSI/ESDA/JEDEC JS-001 ⁽¹⁾	±1500
		TLV3605 Human-body model (HBM), per ANSI/ESDA/JEDEC JS-001 ⁽¹⁾	±2000
		Charged-device model (CDM), per JEDEC specification JESD22-C101 ⁽²⁾	±1000

- JEDEC document JEP155 states that 500-V HBM allows safe manufacturing with a standard ESD control process.
- JEDEC document JEP157 states that 250-V CDM allows safe manufacturing with a standard ESD control process.

6.3 Recommended Operating Conditions

over operating free-air temperature range (unless otherwise noted)

	MIN	MAX	UNIT
Input Supply Voltage: $V_{CCI} - V_{EE}$	2.4	5.5	V
Output Supply Voltage: $V_{CCO} - V_{EE}$	2.4	5.5	V
Input Voltage Range (IN+, IN-)	$V_{EE} - 0.3$	$V_{CCI} + 0.3$	V
Shutdown Enable (\overline{SHDN})	$V_{EE} - 0.3$	$V_{CCO} + 0.3$	V
Latch and Hysteresis Control (\overline{LE}/HYS)	$V_{EE} - 0.3$	$V_{CCO} + 0.3$	V
Ambient temperature, T_A	-40	125	°C

6.4 Thermal Information

THERMAL METRIC		TLV3604	TLV3605	UNIT
		DCK (SC70)	RVK (WQFN)	
		6 PINS	12 PINS	
$R_{\theta JA}$	Junction-to-ambient thermal resistance	170.3	85.8	°C/W
$R_{\theta JC(top)}$	Junction-to-case (top) thermal resistance	134.5	71.6	°C/W
$R_{\theta JC(bottom)}$	Junction-to-case (bottom) thermal resistance	N/A	15.1	°C/W
$R_{\theta JB}$	Junction-to-board thermal resistance	63.3	52.7	°C/W
ψ_{JT}	Junction-to-top characterization parameter	43.7	4.1	°C/W
ψ_{JB}	Junction-to-board characterization parameter	63.1	52.7	°C/W

6.5 Electrical Characteristics (V_{CCI} = V_{CCO} = 2.5 V to 5 V)

V_{CCI} = V_{CCO} = 2.5 to 5 V, V_{EE} = 0 V, V_{CM} = V_{EE} + 300 mV, R_{LOAD} = 100 Ω, C_L = 1 pF probe capacitance, typical at T_A = 25°C (unless otherwise noted).

PARAMETER		TEST CONDITIONS	MIN	TYP	MAX	UNIT
DC Input Characteristics						
V _{IO} ⁽¹⁾	Input offset voltage	V _{CCI} = V _{CCO} = 2.5 V and 5 V T _A = -40°C to +125°C	-5	±0.5	5	mV
V _{CM}	Input common mode voltage range	V _{CCI} = V _{CCO} = 2.5 V and 5 V T _A = -40°C to +125°C	V _{EE} - 0.2		V _{CCI} + 0.2	V
V _{HYST}	Input hysteresis voltage			0		mV
C _{IN}	Input capacitance			1		pF
R _{DM}	Input differential mode resistance			67		kΩ
R _{CM}	Input common mode resistance			5		MΩ
I _B	Input bias current	V _{CCI} = V _{CCO} = 2.5 V and 5 V T _A = -40°C to +125°C	-5	-1	5	μA
I _{OS}	Input offset current	V _{CCI} = V _{CCO} = 2.5 V and 5 V T _A = -40°C to +125°C	-1		1	μA
CMRR ⁽¹⁾	Common-mode rejection ratio	V _{CCI} = V _{CCO} = 2.5 V and 5 V V _{CM} = V _{EE} - 0.2V to V _{CCI} + 0.2V, T _A = -40°C to +125°C	50	80		dB
PSRR ⁽¹⁾	Power-supply rejection ratio	V _{CCI} = V _{CCO} = 2.5 V to 5 V, T _A = -40°C to +125°C	55	80		dB
DC Output Characteristics						
V _{OCM}	Output common mode voltage	V _{CCI} = V _{CCO} = 2.5 V and 5 V T _A = -40°C to +125°C	1.125	1.2	1.375	V
ΔV _{OCM}	Output common mode voltage mismatch	V _{CCI} = V _{CCO} = 2.5 V and 5 V T _A = -40°C to +125°C			50	mV
V _{OCM_PP}	Peak-to-Peak output common mode voltage			20		mVpp
V _{OD}	Differential output voltage	V _{CCI} = V _{CCO} = 2.5 V and 5 V T _A = -40°C to +125°C	250	350	450	mV
ΔV _{OD}	Differential output voltage mismatch	V _{CCI} = V _{CCO} = 2.5 V and 5 V T _A = -40°C to +125°C			10	mV
Power Supply						
I _{CC} (TLV3604)	Total quiescent current	V _{CCI} = V _{CCO} = 2.5 V and 5 V T _A = -40°C to +125°C		12.1	16.5	mA
I _{CCI} (TLV3605)	Input stage quiescent current	V _{CCI} = V _{CCO} = 2.5 V and 5 V T _A = -40°C to +125°C		7.5	10.5	mA
I _{CCO} (TLV3605)	Output stage quiescent current	V _{CCI} = V _{CCO} = 2.5 V and 5 V T _A = -40°C to +125°C		5.2	7.0	mA
AC Characteristics						
t _{PD}	Propagation delay	V _{OVERDRIVE} = V _{UNDERDRIVE} = 50mV, 50 MHz Squarewave		800		ps
t _{PD_SKEW}	Propagation delay skew	V _{OVERDRIVE} = V _{UNDERDRIVE} = 50mV, 50 MHz Squarewave		40		ps
t _{CM_DISPERSION}	Common dispersion	V _{CM} varied from V _{EE} to V _{CCI}		200		ps
t _{OD_DISPERSION}	Overdrive dispersion	Overdrive varied from 10 mV to 250 mV		350		ps
t _{UD_DISPERSION}	Underdrive dispersion	Underdrive varied from 10mV to 250 mV		200		ps
t _R	Rise time	20% to 80%		350		ps
t _F	Fall time	80% to 20%		350		ps
f _{TOGGLE}	Input toggle frequency	V _{IN} = 200 mV _{PP} Sine Wave, 50% Output swing		1.5		GHz
TR	Toggle Rate	V _{IN} = 200 mV _{PP} Sine Wave, 50% Output swing		3.0		Gbps
PulseWidth	Minimum allowed input pulse width	V _{OVERDRIVE} = V _{UNDERDRIVE} = 50mV PW _{OUT} = 90% of PW _{IN}		600		ps
Latching/Adjustable Hysteresis (TLV3605 only)						
V _{HYST}	Input hysteresis voltage	R _{HYST} = Floating		0		mV
V _{HYST}	Input hysteresis voltage	R _{HYST} = 150 kΩ		30		mV

6.5 Electrical Characteristics ($V_{CCI} = V_{CCO} = 2.5\text{ V to }5\text{ V}$) (continued)

$V_{CCI} = V_{CCO} = 2.5\text{ to }5\text{ V}$, $V_{EE} = 0\text{ V}$, $V_{CM} = V_{EE} + 300\text{ mV}$, $R_{LOAD} = 100\ \Omega$, $C_L = 1\text{ pF}$ probe capacitance, typical at $T_A = 25^\circ\text{C}$ (unless otherwise noted).

PARAMETER		TEST CONDITIONS	MIN	TYP	MAX	UNIT
V_{HYST}	Input hysteresis voltage	$R_{HYST} = 56\text{ k}\Omega$		60		mV
V_{IH_LE}	\overline{LE} pin input high level	$V_{CCI} = V_{CCO} = 2.5\text{ V and }5\text{ V}$ $T_A = -40^\circ\text{C to }+125^\circ\text{C}$	1.5			V
V_{IL_LE}	\overline{LE} pin input low level	$V_{CCI} = V_{CCO} = 2.5\text{ V and }5\text{ V}$ $T_A = -40^\circ\text{C to }+125^\circ\text{C}$			0.35	V
I_{IH_LE}	\overline{LE} pin input leakage current	$V_{LE} = V_{CCO}$ $T_A = -40^\circ\text{C to }+125^\circ\text{C}$			3.5	μA
I_{IL_LE}	\overline{LE} pin input leakage current	$V_{LE} = V_{EE}$, $T_A = -40^\circ\text{C to }+125^\circ\text{C}$			40	μA
t_{SETUP}	Latch setup time			-3		ns
t_{HOLD}	Latch hold time			6		ns
t_{PL}	Latch to Q and \overline{Q} delay			4		ns
Shutdown Characteristics (TLV3605 only)						
V_{IH_SD}	\overline{SHDN} pin input high level	$V_{CCI} = V_{CCO} = 2.5\text{ V and }5\text{ V}$ $T_A = -40^\circ\text{C to }+125^\circ\text{C}$	1.5			V
V_{IL_SD}	\overline{SHDN} pin input low level	$V_{CCI} = V_{CCO} = 2.5\text{ V and }5\text{ V}$ $T_A = -40^\circ\text{C to }+125^\circ\text{C}$			0.4	V
I_{IH_SD}	\overline{SHDN} pin input leakage current	$V_{CCI} = V_{CCO} = 2.5\text{ V and }5\text{ V}$ $V_{SD} = V_{CCO}$, $T_A = -40^\circ\text{C to }+125^\circ\text{C}$			2	μA
I_{IL_SD}	\overline{SHDN} pin input leakage current	$V_{CCI} = V_{CCO} = 2.5\text{ V and }5\text{ V}$ $V_{SD} = V_{EE}$, $T_A = -40^\circ\text{C to }+125^\circ\text{C}$			30	μA
I_{CCI_SD}	Input stage quiescent current in Shutdown mode	$V_{CCI} = V_{CCO} = 2.5\text{ V and }5\text{ V}$ $T_A = -40^\circ\text{C to }+125^\circ\text{C}$			1.5	mA
I_{CCO_SD}	Output stage quiescent current in Shutdown mode	$V_{CCI} = V_{CCO} = 2.5\text{ V and }5\text{ V}$ $T_A = -40^\circ\text{C to }+125^\circ\text{C}$			100	μA
t_{SLEEP}	Sleep time from Active to Shutdown mode	10% output swing		8		ns
t_{WAKEUP}	Wake up time from Shutdown mode	$V_{OD} = 50\text{ mV}$, output valid		100		ns

(1) For TLV3605, the V_{IO} is tested with $R_{HYST} = 150\text{ k}\Omega$

6.6 Typical Characteristics

At $T_A = 25^\circ\text{C}$, $V_{CC1}/V_{CC0} = 2.5\text{ V to }5.0\text{ V}$, $V_{CM} = 0.3\text{ V}$, and input overdrive/underdrive = 50 mV unless otherwise noted.

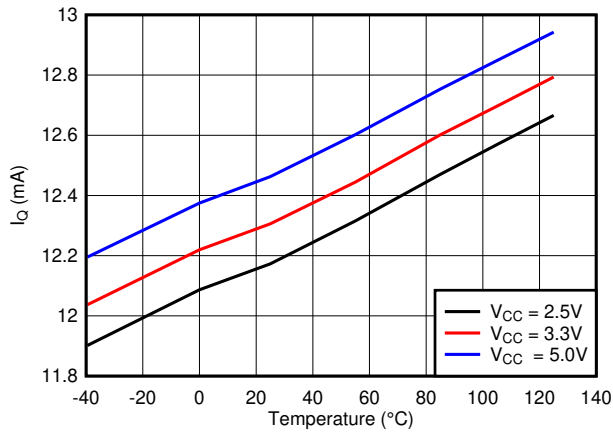

Figure 6-1. I_Q vs Temperature

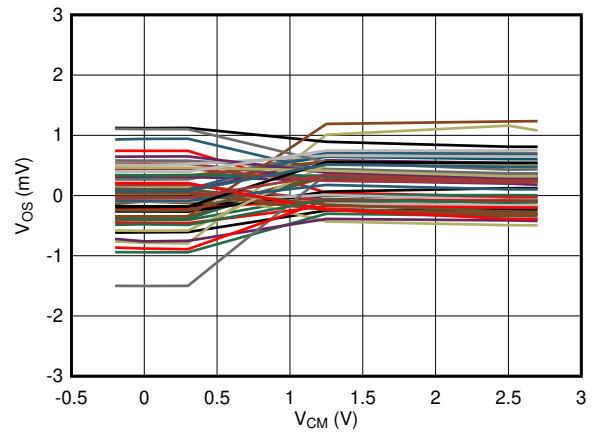

Figure 6-2. V_{OS} vs V_{CM} @ $V_{CC} = 2.5\text{ V} - 50$ Devices

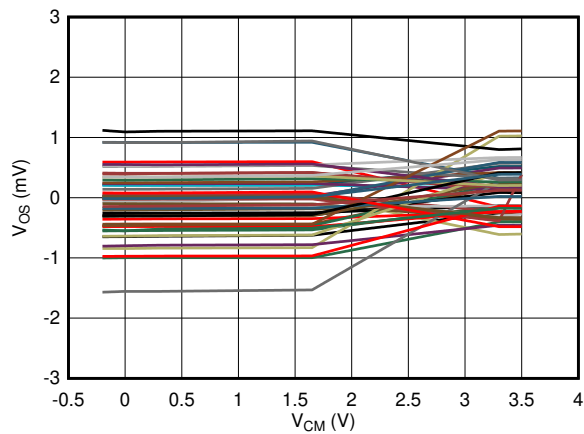

Figure 6-3. V_{OS} vs V_{CM} @ $V_{CC} = 3.3\text{ V} - 50$ Devices

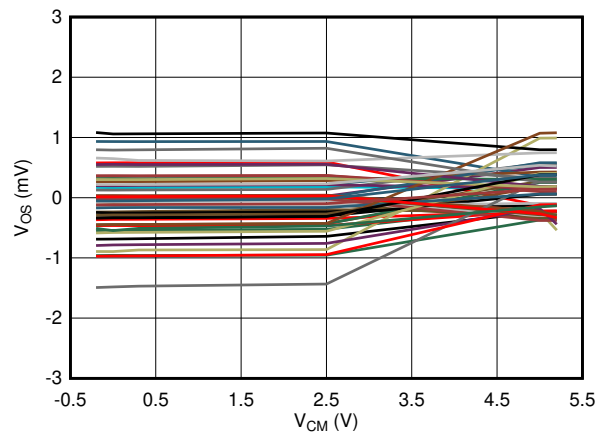

Figure 6-4. V_{OS} vs V_{CM} @ $V_{CC} = 5.0\text{ V} - 50$ Devices

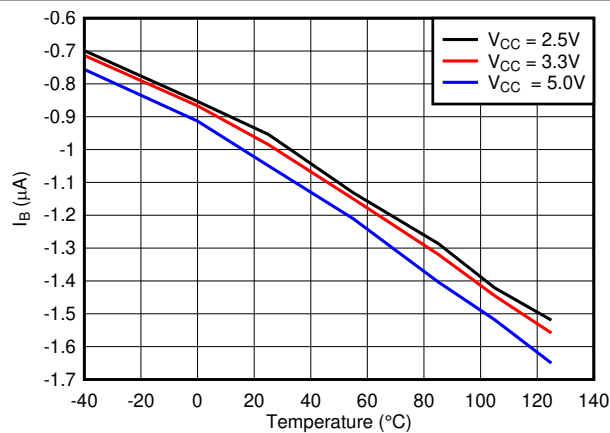

Figure 6-5. Bias Current vs Temperature

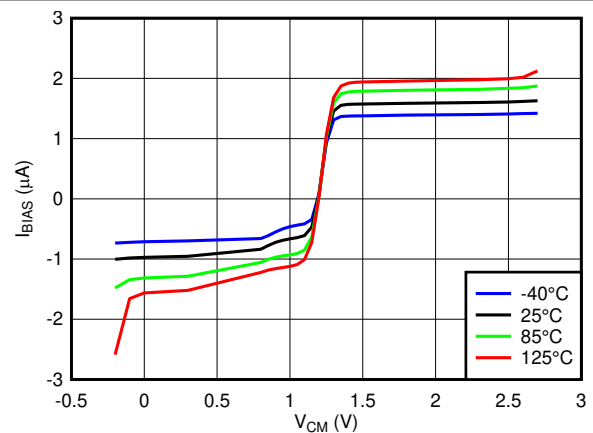

Figure 6-6. Input Bias Current vs V_{CM} @ $V_{CC} = 2.5\text{ V}$

6.6 Typical Characteristics (continued)

At $T_A = 25^\circ\text{C}$, $V_{CCI}/V_{CCO} = 2.5\text{ V to }5.0\text{ V}$, $V_{CM} = 0.3\text{ V}$, and input overdrive/underdrive = 50 mV unless otherwise noted.

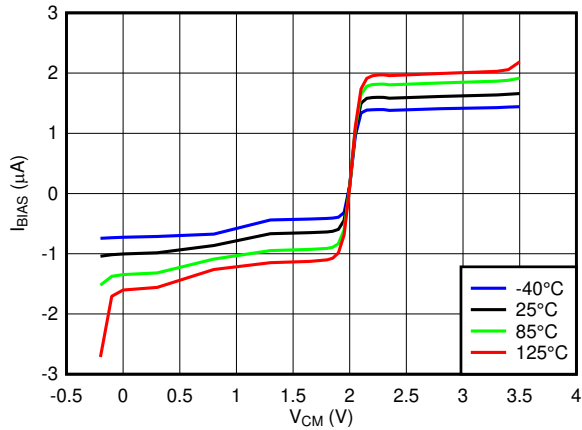

Figure 6-7. Input Bias Current vs V_{CM} @ $V_{CC} = 3.3\text{ V}$

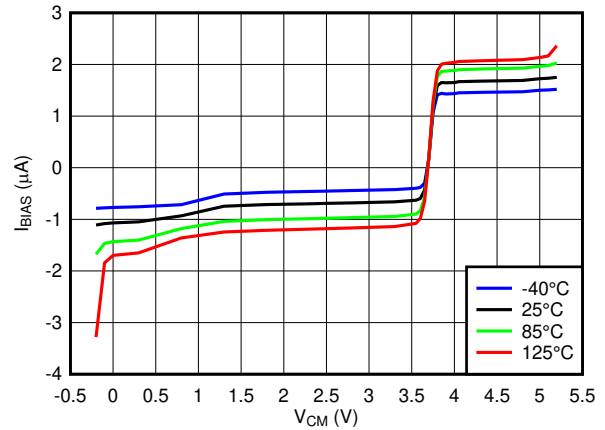

Figure 6-8. Input Bias Current vs V_{CM} @ $V_{CC} = 5.0\text{ V}$

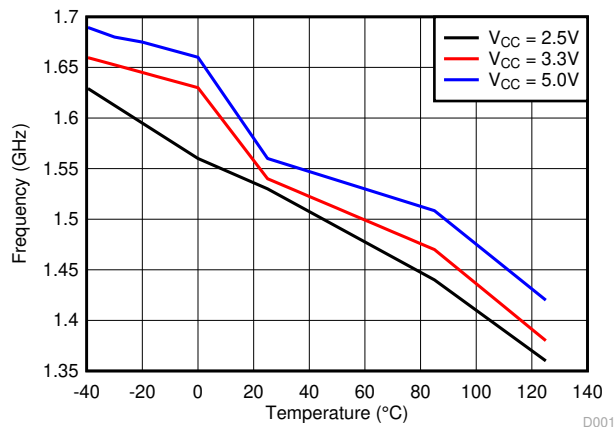

Figure 6-9. F_{toggle} vs Temperature

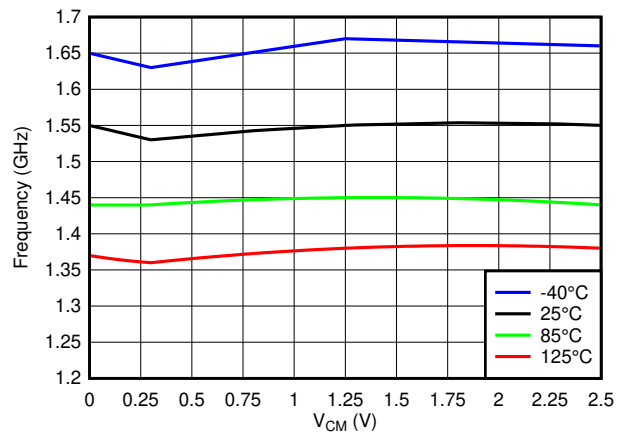

Figure 6-10. F_{toggle} vs V_{CM} @ $V_{CC} = 2.5\text{ V}$

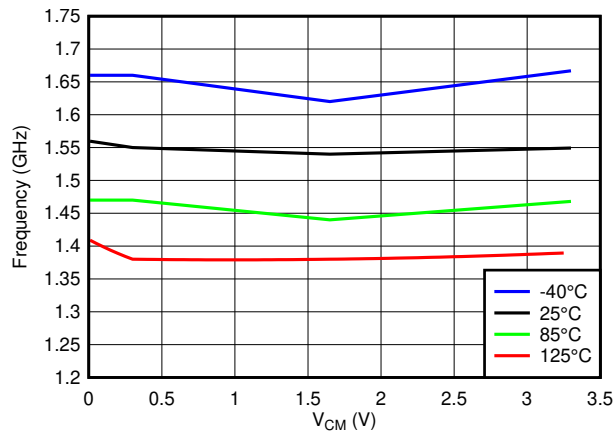

Figure 6-11. F_{toggle} vs V_{CM} @ $V_{CC} = 3.3\text{ V}$

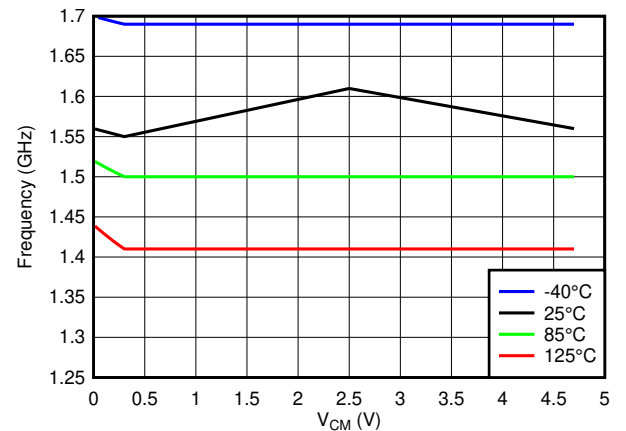

Figure 6-12. F_{toggle} vs V_{CM} @ $V_{CC} = 5.0\text{ V}$

6.6 Typical Characteristics (continued)

At $T_A = 25^\circ\text{C}$, $V_{CC1}/V_{CC0} = 2.5\text{ V to }5.0\text{ V}$, $V_{CM} = 0.3\text{ V}$, and input overdrive/underdrive = 50 mV unless otherwise noted.

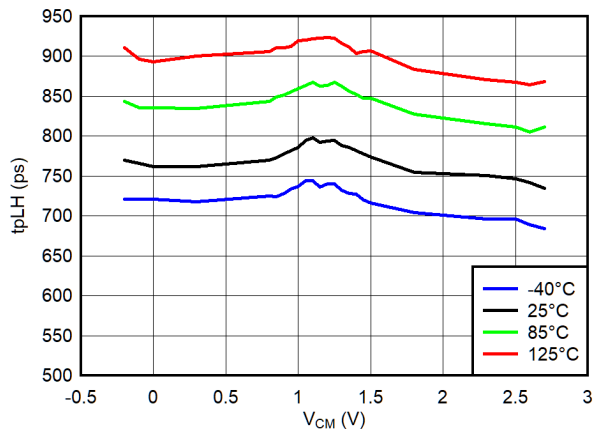

Figure 6-13. T_{PLH} vs V_{CM} @ $V_{CC} = 2.5\text{ V}$

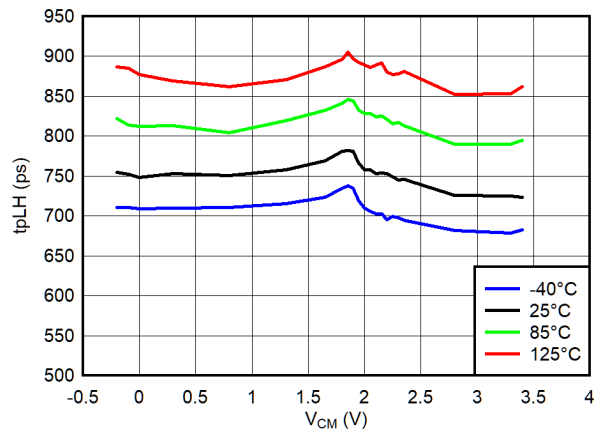

Figure 6-14. T_{PLH} vs V_{CM} @ $V_{CC} = 3.3\text{ V}$

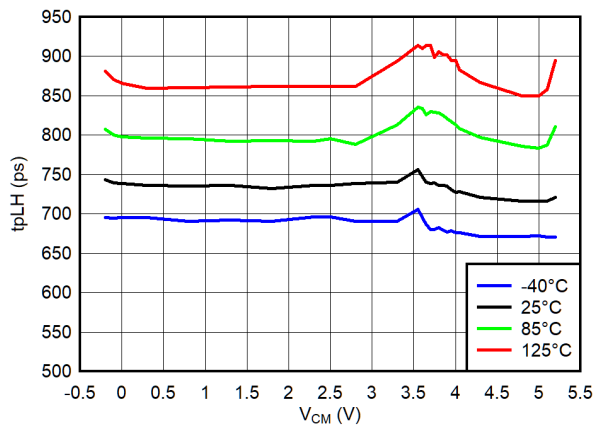

Figure 6-15. T_{PLH} vs V_{CM} @ $V_{CC} = 5.0\text{ V}$

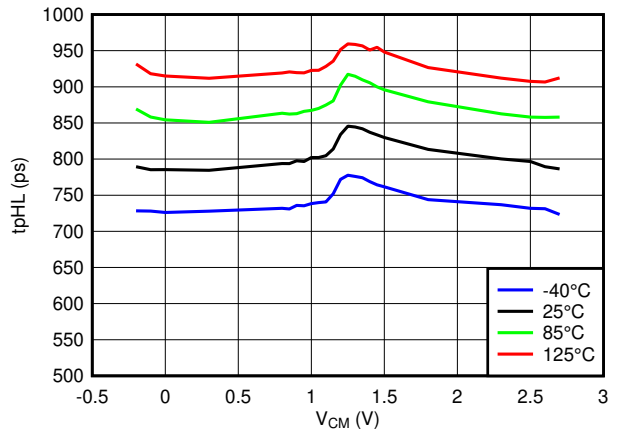

Figure 6-16. T_{PHL} vs V_{CM} @ $V_{CC} = 2.5\text{ V}$

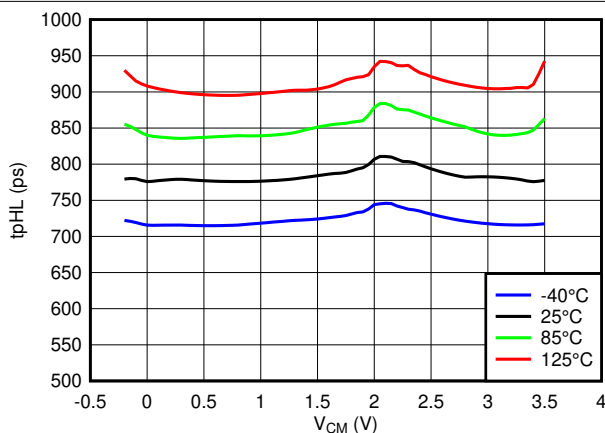

Figure 6-17. T_{PHL} vs V_{CM} @ $V_{CC} = 3.3\text{ V}$

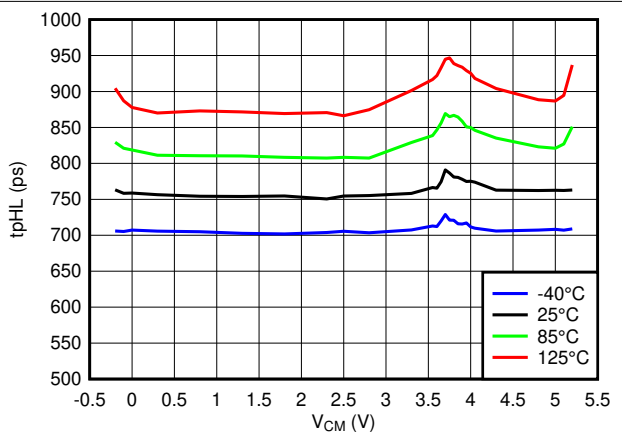

Figure 6-18. T_{PHL} vs V_{CM} @ $V_{CC} = 5.0\text{ V}$

6.6 Typical Characteristics (continued)

At $T_A = 25^\circ\text{C}$, $V_{CC1}/V_{CC0} = 2.5\text{ V to }5.0\text{ V}$, $V_{CM} = 0.3\text{ V}$, and input overdrive/underdrive = 50 mV unless otherwise noted.

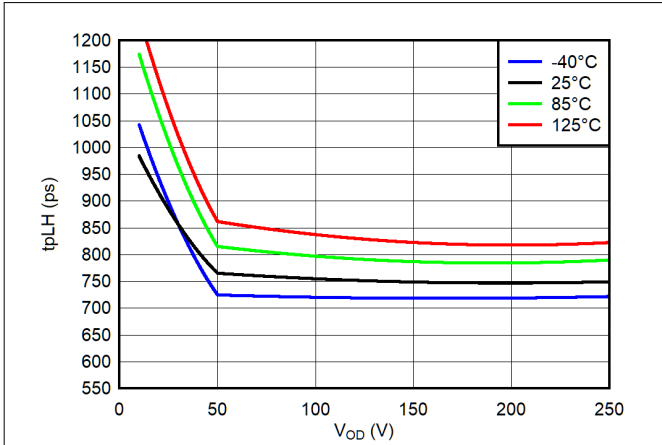

Figure 6-19. T_{PLH} vs Input Overdrive @ $V_{CC} = 2.5\text{ V}$

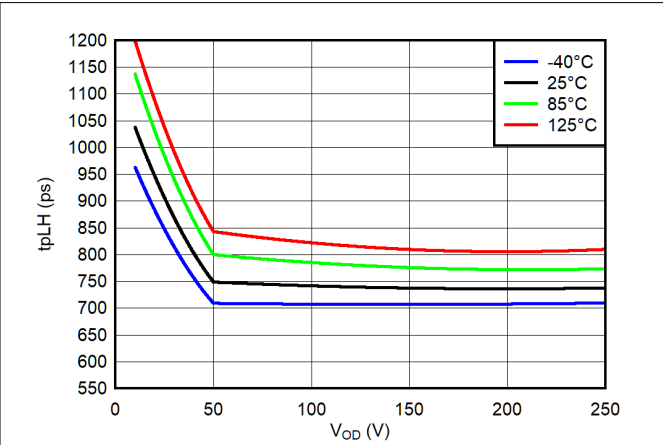

Figure 6-20. T_{PLH} vs Input Overdrive @ $V_{CC} = 3.3\text{ V}$

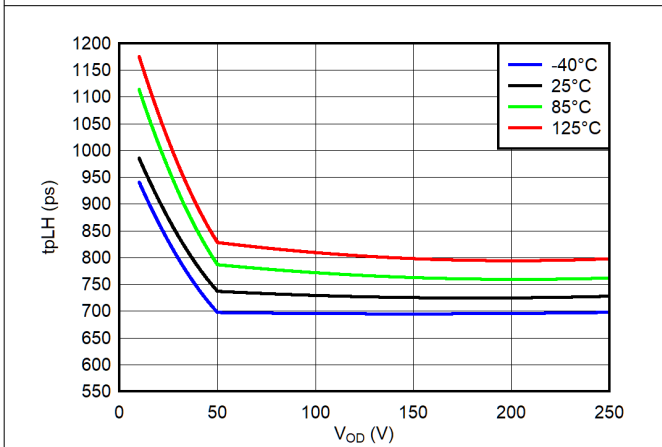

Figure 6-21. T_{PLH} vs Input Overdrive @ $V_{CC} = 5.0\text{ V}$

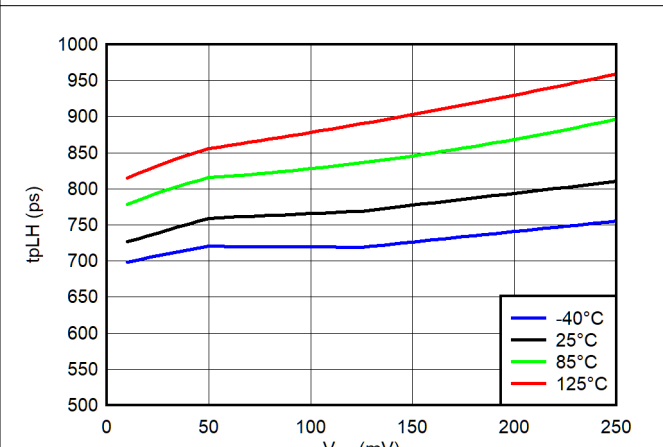

Figure 6-22. T_{PLH} vs Input Underdrive @ $V_{CC} = 2.5\text{ V}$

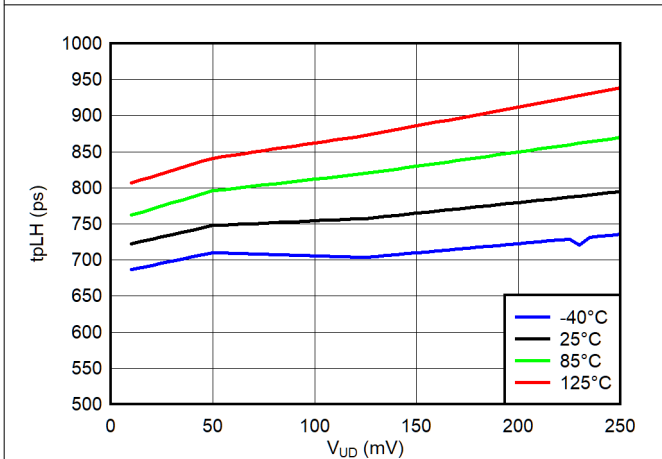

Figure 6-23. T_{PLH} vs Input Underdrive @ $V_{CC} = 3.3\text{ V}$

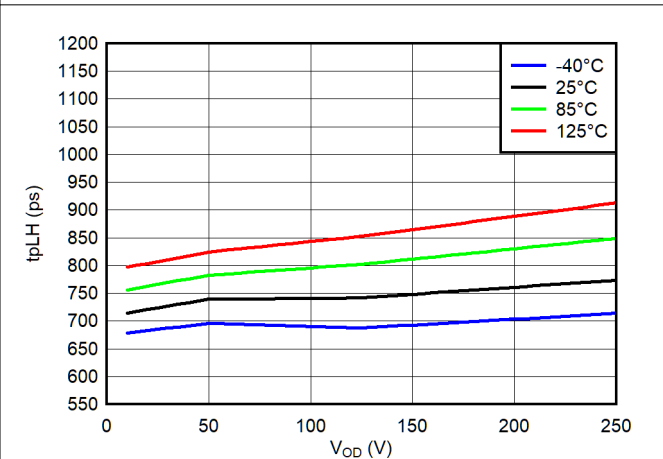

Figure 6-24. T_{PLH} vs Input Underdrive @ $V_{CC} = 5.0\text{ V}$

7 Detailed Description

7.1 Overview

The TLV3604 and TLV3605 are 800-ps, high-speed comparators with LVDS outputs and rail-to-rail inputs. These features, along with an operating voltage range of 2.4 V to 5.5 V and a high toggle frequency of 3 Gbps, make the TLV3604 and TLV3605 well suited for LIDAR, clock and data recovery applications, and test and measurement systems.

7.2 Functional Block Diagram

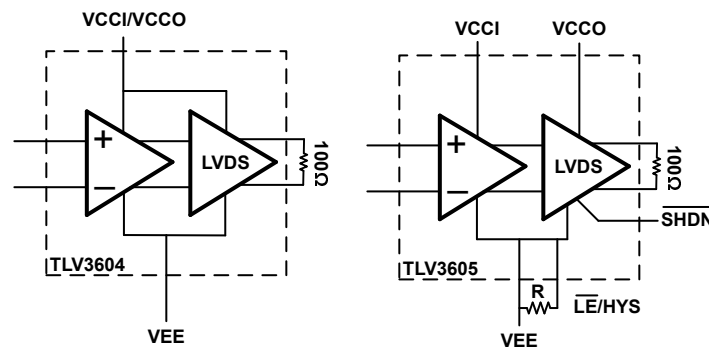

7.3 Feature Description

The TLV3604 and TLV3605 are single channel, high-speed comparators with rail-to-rail inputs and LVDS outputs. The rail-to-rail input stage is capable of operating up to 200 mV beyond each power supply rail with minimal input offset. The TLV3605 has similar performance while providing adjustable hysteresis, latching function, and shutdown mode.

7.4 Device Functional Modes

The TLV3604 has a single functional mode and is operational when the power supply voltage is greater than the minimum operating voltage. On the other hand, the TLV3605 has an active and shutdown mode. The TLV3605 is in shutdown mode when the $\overline{\text{SHDN}}$ pin is logic low. To allow for easy interface with 1.8V FPGAs and CPUs, The $\overline{\text{SHDN}}$ pin is 1.8 V logic compliant and independent of the comparator power supply.

7.4.1 Rail-to-Rail Inputs

The TLV3604 and TLV3605 feature input stages capable of operating 200mV below or above the power supply rails, allowing for zero cross detection and maximizing input dynamic range. With low input offset voltage, the comparators improve system performance in high sensitivity signal detection.

7.4.2 LVDS Output

The TLV3604 and TLV3605 output are LVDS compliant. When the input of the downstream device is terminated with a 100 Ω resistor, it provides a ± 350 mV LVDS swing. Fully differential outputs enable fast digital toggling and reduce EMI compared to single-ended output standards.

8 Application and Implementation

Note

Information in the following applications sections is not part of the TI component specification, and TI does not warrant its accuracy or completeness. TI's customers are responsible for determining suitability of components for their purposes, as well as validating and testing their design implementation to confirm system functionality.

8.1 Application Information

The TLV360x comparators feature rail-to-rail inputs and a LVDS output stage that is well-suited for high speed applications that require low power consumption. The 800 ps propagation delay of the comparators improve performance and extend the range for applications involving optical reception, triggers for test and measurement systems, and transceivers that require a high speed signal to be carried over a certain distance.

8.1.1 Comparator Inputs

The TLV360x is a rail-to-rail input comparator, with an input common-mode range that exceeds the supply rails by 200 mV for both positive and negative supplies.

8.1.2 Capacitive Loads

Under reasonable capacitive loads, the device maintains specified propagation delay. However, excessive capacitive loading under high switching frequencies may increase supply current, propagation delay, or induce decreased slew rate.

8.1.3 Latch Functionality

The latch pin for the TLV3605 holds the output state of the device when the voltage at the LE/HYST pin is less than 800mV above V_{EE} . This is particularly useful when the output state is intended to remain unchanged. An important consideration of the latch functionality is the latch hold time. Latch hold time is the minimum time (after the latch pin is asserted) required for properly latching the comparator output.

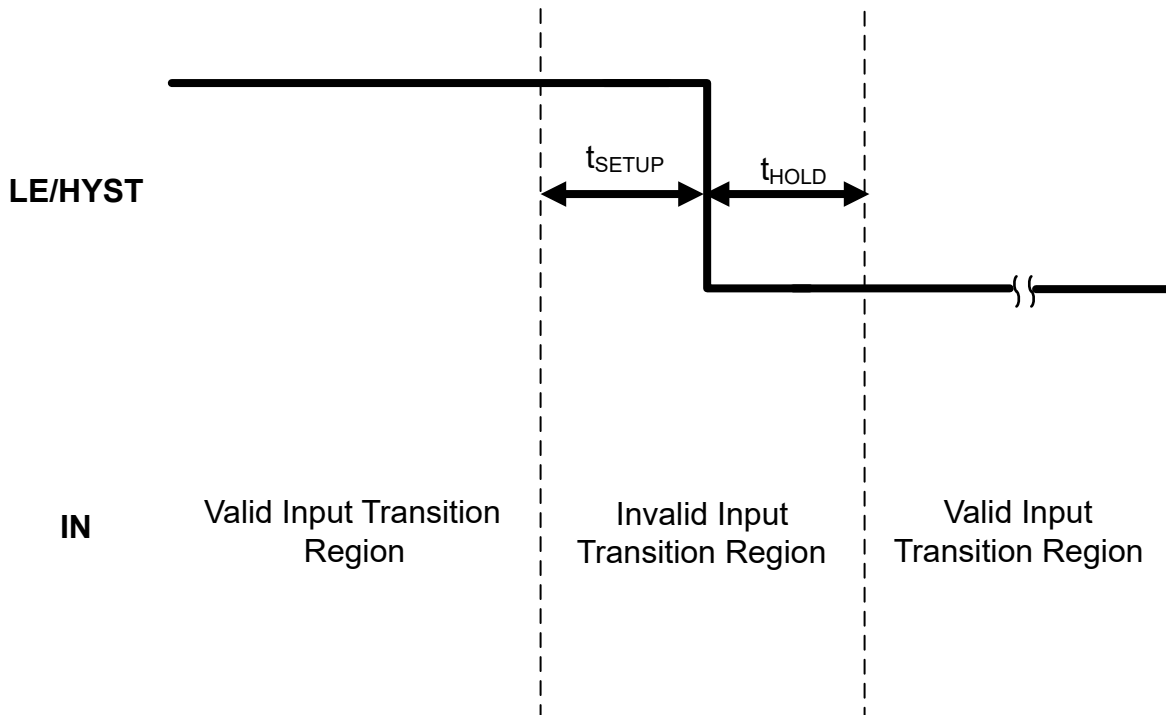

Figure 8-1. Valid Latch Diagram

Likewise, latch setup time is defined as the time that the input must be stable before the latch pin is asserted low. The figure above illustrates when the input can transition for a valid latch. Note that the typical setup time in the EC table is negative; this is due to the internal trace delays of the LE/HYST pin relative to the input pin trace delays.

A small delay in the output response is shown below when the TLV3605 exits a latched output stage.

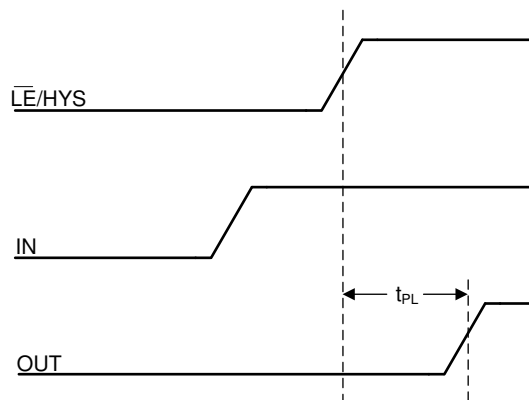

Figure 8-2. Latch Disable with Input Change

8.1.4 Adjustable Hysteresis

As a result of a comparator’s high open loop gain, there is a small band of input differential voltage where the output can toggle back and forth between “logic high” and “logic low” states. This can cause design challenges for inputs with slow rise and fall times or systems with excessive noise.

These challenges can be overcome by adding hysteresis to the comparator. Since the TLV3604 does not have internal hysteresis, external hysteresis can be applied in the form of a positive feedback loop that adjusts the trip point of the comparator depending on its current output state. See the Typical Application section for more details.

The TLV3605 on the other hand has a LE/HYST pin that can be used to increase the internal hysteresis of the comparator. In order to change the internal hysteresis of the TLV3605, connect a single resistor as shown in the [adjusting hysteresis figure](#) between the LE/HYST pin and VEE. A curve of hysteresis versus resistance is provided below to provide guidance in setting the desired amount of hysteresis.

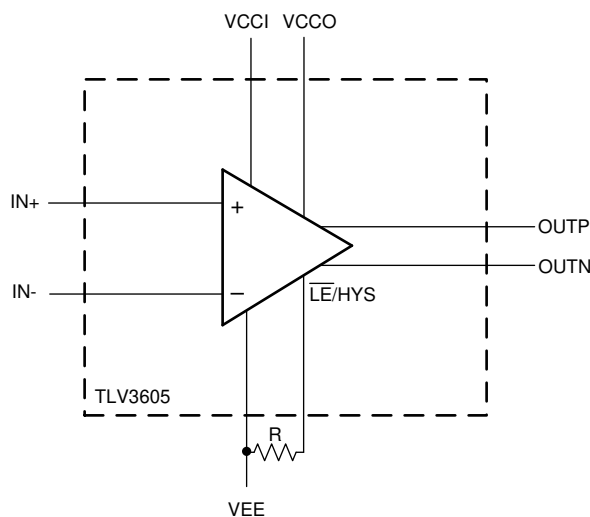

Figure 8-3. Adjusting Hysteresis with an External Resistor (R)

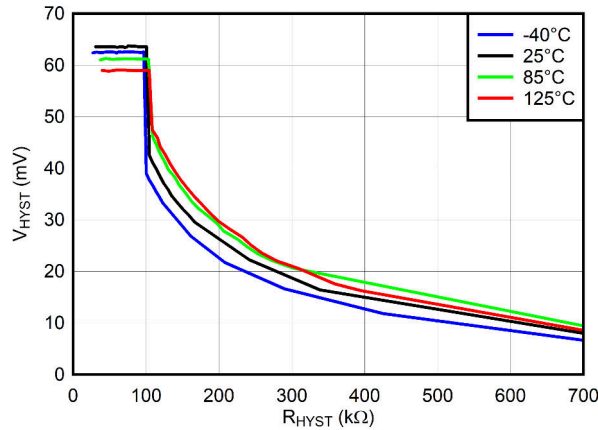

Figure 8-4. V_{HYST} (mV) vs R_{HYST} (kΩ), V_{CC} = 3.3V

8.2 Typical Application

8.2.1 Non-Inverting Comparator With Hysteresis

A way to implement external hysteresis to the TLV3604 is to add two resistors to the circuit: one in series between the reference voltage and the inverting pin, and another from the inverting pin to one of the differential output pins.

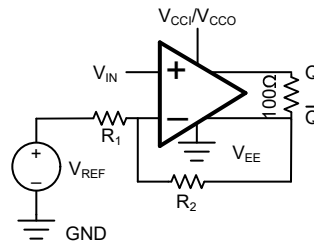

Figure 8-5. Non-Inverting Comparator with Hysteresis Circuit

8.2.1.1 Design Requirements

Table 8-1. Design Parameters

PARAMETER	VALUE
V _{HYS}	20mV
V _{REF}	5V
V _{T1}	3.6V
V _{T2}	3.4V
Q	1.375V
\bar{Q}	1.025V

8.2.1.2 Detailed Design Procedure

First, create an equation for V_T that covers both output voltages when the output is high or low.

$$V_{T1} = \frac{V_{REF}R_2 + QR_1}{R_1 + R_2} \quad (1)$$

$$V_{T2} = \frac{V_{REF}R_2 + \bar{Q}R_1}{R_1 + R_2} \quad (2)$$

The hysteresis voltage in this network is equal to the difference in the two threshold voltage equations.

$$V_{\text{HYS}} = V_{\text{T1}} - V_{\text{T2}} \quad (3)$$

$$V_{\text{HYS}} = \frac{V_{\text{REF}}R_2 + QR_1}{R_1 + R_2} - \frac{V_{\text{REF}}R_2 - \bar{Q}R_1}{R_1 + R_2} \quad (4)$$

$$V_{\text{HYS}} = \frac{(Q - \bar{Q})R_1}{R_1 + R_2} \quad (5)$$

$$V_{\text{HYS}} = \frac{V_{\text{OD}}R_1}{R_1 + R_2} \quad (6)$$

Select a value for R2. Plug in given values for V_{REF} , V_{T1} , V_{T2} , Q, and \bar{Q} , and solve for R1. For the given example, R2 = 100 k Ω , and R1 is solved as = 67.37 k Ω .

8.2.1.3 Application Performance Plots

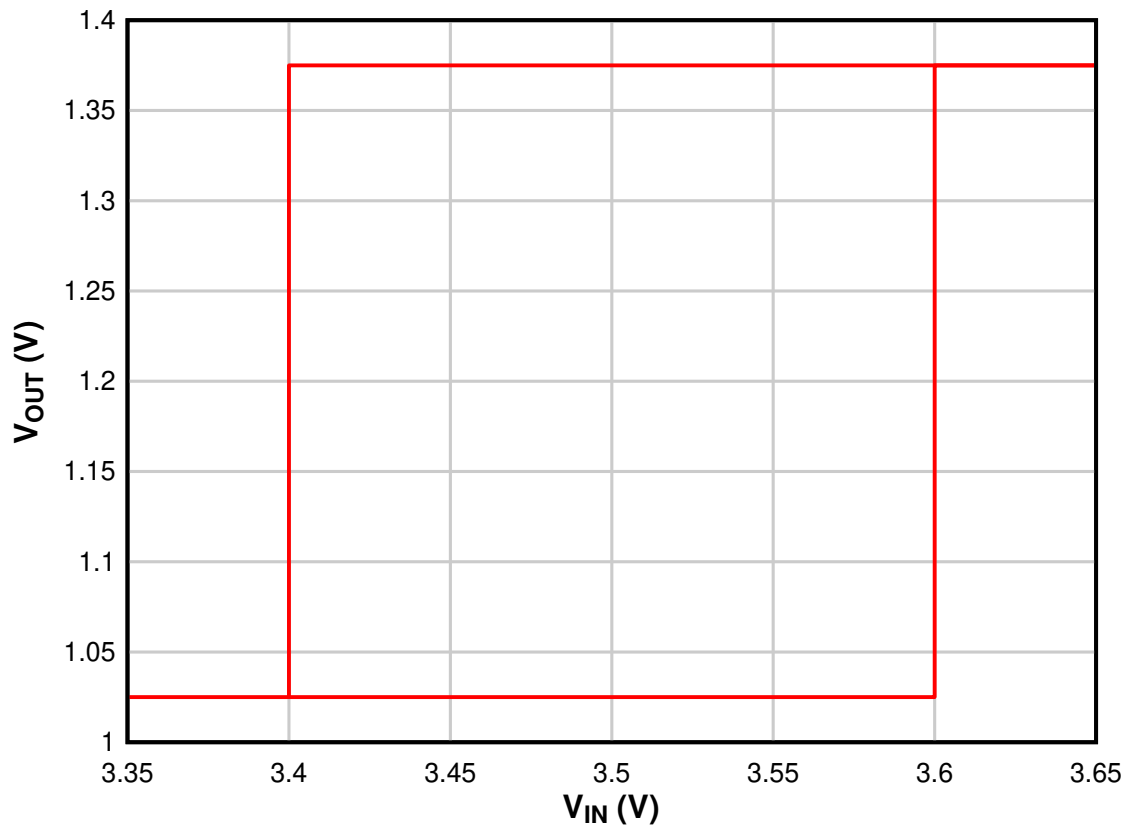

Figure 8-6. Hysteresis Curve for LVDS Comparator

8.2.2 Optical Receiver

The TLV360x can be used in conjunction with a high performance amplifier such as the OPA855 to create an optical receiver as shown in the [Figure 8-7](#). The photo diode is connected to a bias voltage and is being driven with a pulsed laser. The OPA855 takes the current conducting through the diode and translates it into a voltage for a high speed comparator to detect. The TLV360x will then output the proper LVDS signal according to the threshold set (V_{REF2}).

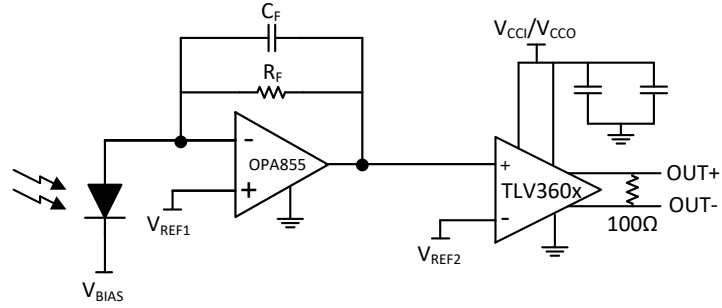

Figure 8-7. Optical Receiver

8.2.3 Logic Clock Source to LVDS Transceiver

The Figure 8-8 shows a logic clock source being terminated and driven with the TLV360x across a CAT6 Cable to receive an equivalent LVDS clock signal at the receiver end.

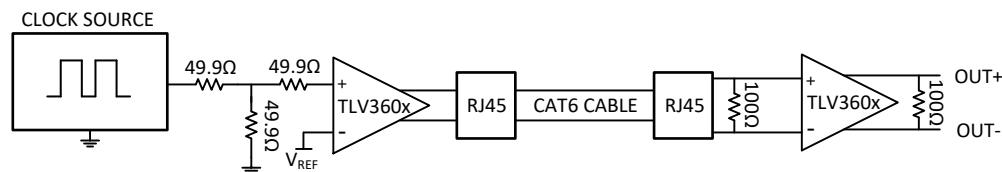

Figure 8-8. LVDS Clock Transceiver

8.2.4 External Trigger Function for Oscilloscopes

Figure 8-9 is a typical configuration for creating an external trigger on oscilloscopes. The user adjusts the trigger level, and a DAC converts this trigger level to a voltage the TLV360x can use as a reference. The input voltage from an oscilloscope channel is then compared to the trigger reference voltage, and the TLV360x sends an LVDS signal to a downstream FPGA to begin a capture.

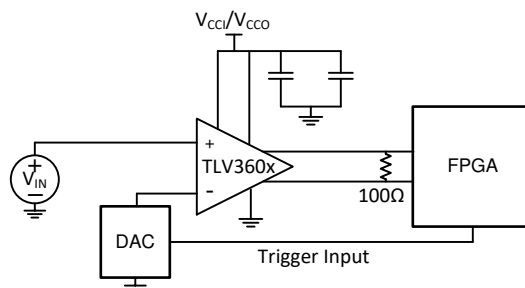

Figure 8-9. External Trigger Function

9 Power Supply Recommendations

The TLV3604 and TLV3605 are recommended for operation from 2.4 V to 5.5 V. One benefit of the TLV3605 is that the comparator has separate input and output supply pins (VCCI and VCCO). This provides a system designer the flexibility of powering the input stage with a higher supply voltage such as 5V to maximize the dynamic range of the input while powering the output stage with a 2.5V supply to save power. Regardless of the VCCO supply voltage, the control pins such as LE and SHDN are 1.8V logic compliant.

10 Layout

10.1 Layout Guidelines

Comparators are very sensitive to input noise. For best results, adhere to the following layout guidelines.

1. Use a printed-circuit-board (PCB) with a good, unbroken, low-inductance ground plane. Proper grounding (use of a ground plane) helps maintain specified device performance and input/output trace impedances.
2. To minimize supply noise, place a decoupling capacitor (0.1- μ F ceramic, surface-mount capacitor) directly between VCCI/VCCO and VEE.
3. On the inputs and outputs, utilize matched trace lengths to minimize timing skew. Also, minimize trace lengths and maximize ground pour spacings around the input and output traces to limit parasitic capacitance.
4. Solder the device directly to the PCB rather than using a socket.
5. For slow-moving input signals, take care to prevent parasitic feedback. A small capacitor (1000 pF or less) placed between the inputs can help eliminate oscillations in the transition region. This capacitor causes minimal degradation to propagation delay when source impedance is low.
6. Use a 100 Ω termination resistor across the device's LVDS outputs.
7. Use higher performance substrate materials such as Rogers or High-Speed FR4.
8. PCB signal layers from the TLV3604EVM are shown for reference.

10.2 Layout Example

[Figure 10-1](#) shows the 4 layer PCB signal routing for the TLV3604EVM as an example for how layout on this device can be done.

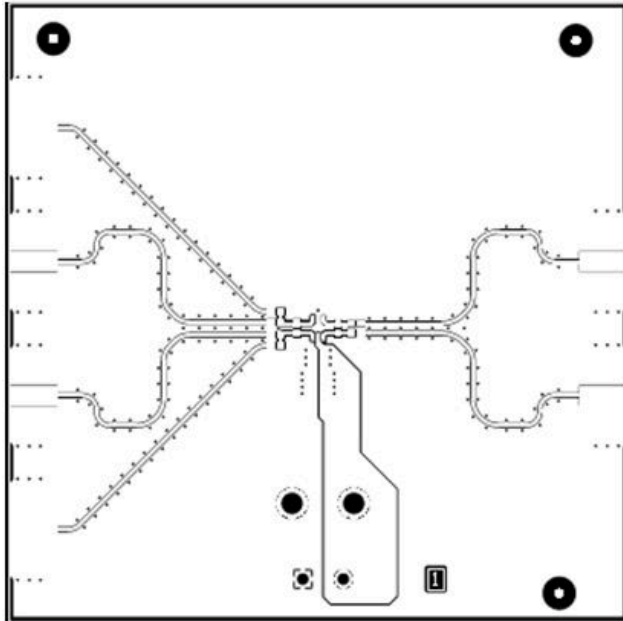

Top Layer

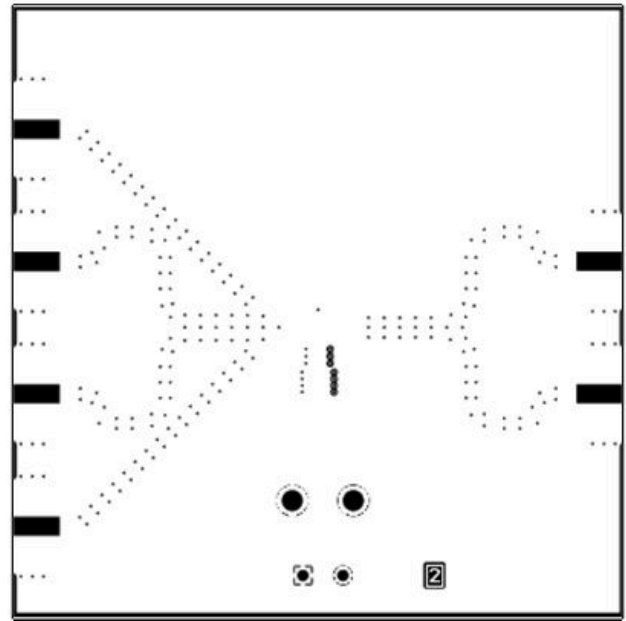

GND-1 Layer

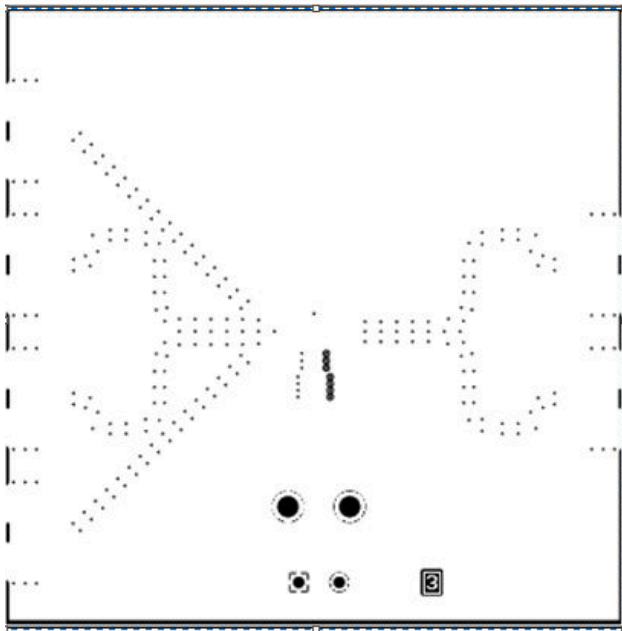

GND-2 Layer

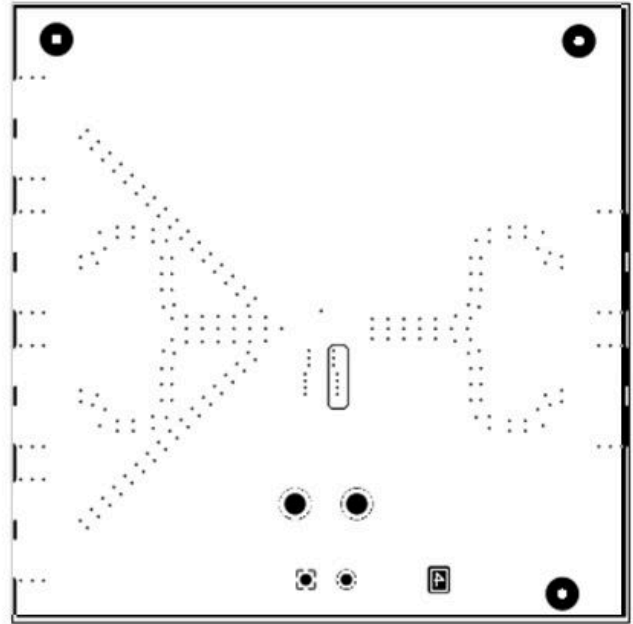

Bottom Layer

Figure 10-1. TLV3604EVM Layout Example

11 Device and Documentation Support

11.1 Device Support

11.1.1 Development Support

[LIDAR Pulsed Time of Flight Reference Design](#)

11.2 Receiving Notification of Documentation Updates

To receive notification of documentation updates, navigate to the device product folder on [ti.com](#). Click on *Subscribe to updates* to register and receive a weekly digest of any product information that has changed. For change details, review the revision history included in any revised document.

11.3 Support Resources

[TI E2E™ support forums](#) are an engineer's go-to source for fast, verified answers and design help — straight from the experts. Search existing answers or ask your own question to get the quick design help you need.

Linked content is provided "AS IS" by the respective contributors. They do not constitute TI specifications and do not necessarily reflect TI's views; see TI's [Terms of Use](#).

11.4 Trademarks

TI E2E™ is a trademark of Texas Instruments.
All trademarks are the property of their respective owners.

11.5 Electrostatic Discharge Caution



This integrated circuit can be damaged by ESD. Texas Instruments recommends that all integrated circuits be handled with appropriate precautions. Failure to observe proper handling and installation procedures can cause damage.

ESD damage can range from subtle performance degradation to complete device failure. Precision integrated circuits may be more susceptible to damage because very small parametric changes could cause the device not to meet its published specifications.

11.6 Glossary

[TI Glossary](#) This glossary lists and explains terms, acronyms, and definitions.

12 Mechanical, Packaging, and Orderable Information

The following pages include mechanical, packaging, and orderable information. This information is the most current data available for the designated devices. This data is subject to change without notice and revision of this document. For browser-based versions of this data sheet, refer to the left-hand navigation.

PACKAGING INFORMATION

Orderable Device	Status (1)	Package Type	Package Drawing	Pins	Package Qty	Eco Plan (2)	Lead finish/ Ball material (6)	MSL Peak Temp (3)	Op Temp (°C)	Device Marking (4/5)	Samples
TLV3604DCKR	ACTIVE	SC70	DCK	6	3000	RoHS & Green	NIPDAU	Level-1-260C-UNLIM	-40 to 125	1HF	Samples
TLV3604DCKT	ACTIVE	SC70	DCK	6	250	RoHS & Green	NIPDAU	Level-1-260C-UNLIM	-40 to 125	1HF	Samples
TLV3605RVKR	ACTIVE	WQFN	RVK	12	3000	RoHS & Green	NIPDAU	Level-1-260C-UNLIM	-40 to 125	3605	Samples
TLV3605RVKT	ACTIVE	WQFN	RVK	12	250	RoHS & Green	NIPDAU	Level-1-260C-UNLIM	-40 to 125	3605	Samples

(1) The marketing status values are defined as follows:

ACTIVE: Product device recommended for new designs.

LIFEBUY: TI has announced that the device will be discontinued, and a lifetime-buy period is in effect.

NRND: Not recommended for new designs. Device is in production to support existing customers, but TI does not recommend using this part in a new design.

PREVIEW: Device has been announced but is not in production. Samples may or may not be available.

OBSOLETE: TI has discontinued the production of the device.

(2) **RoHS:** TI defines "RoHS" to mean semiconductor products that are compliant with the current EU RoHS requirements for all 10 RoHS substances, including the requirement that RoHS substance do not exceed 0.1% by weight in homogeneous materials. Where designed to be soldered at high temperatures, "RoHS" products are suitable for use in specified lead-free processes. TI may reference these types of products as "Pb-Free".

RoHS Exempt: TI defines "RoHS Exempt" to mean products that contain lead but are compliant with EU RoHS pursuant to a specific EU RoHS exemption.

Green: TI defines "Green" to mean the content of Chlorine (Cl) and Bromine (Br) based flame retardants meet JS709B low halogen requirements of <=1000ppm threshold. Antimony trioxide based flame retardants must also meet the <=1000ppm threshold requirement.

(3) MSL, Peak Temp. - The Moisture Sensitivity Level rating according to the JEDEC industry standard classifications, and peak solder temperature.

(4) There may be additional marking, which relates to the logo, the lot trace code information, or the environmental category on the device.

(5) Multiple Device Markings will be inside parentheses. Only one Device Marking contained in parentheses and separated by a "-" will appear on a device. If a line is indented then it is a continuation of the previous line and the two combined represent the entire Device Marking for that device.

(6) Lead finish/Ball material - Orderable Devices may have multiple material finish options. Finish options are separated by a vertical ruled line. Lead finish/Ball material values may wrap to two lines if the finish value exceeds the maximum column width.

Important Information and Disclaimer: The information provided on this page represents TI's knowledge and belief as of the date that it is provided. TI bases its knowledge and belief on information provided by third parties, and makes no representation or warranty as to the accuracy of such information. Efforts are underway to better integrate information from third parties. TI has taken and

continues to take reasonable steps to provide representative and accurate information but may not have conducted destructive testing or chemical analysis on incoming materials and chemicals. TI and TI suppliers consider certain information to be proprietary, and thus CAS numbers and other limited information may not be available for release.

In no event shall TI's liability arising out of such information exceed the total purchase price of the TI part(s) at issue in this document sold by TI to Customer on an annual basis.

TAPE AND REEL INFORMATION

QUADRANT ASSIGNMENTS FOR PIN 1 ORIENTATION IN TAPE

*All dimensions are nominal

Device	Package Type	Package Drawing	Pins	SPQ	Reel Diameter (mm)	Reel Width W1 (mm)	A0 (mm)	B0 (mm)	K0 (mm)	P1 (mm)	W (mm)	Pin1 Quadrant
TLV3604DCKR	SC70	DCK	6	3000	180.0	8.4	2.47	2.3	1.25	4.0	8.0	Q3
TLV3604DCKT	SC70	DCK	6	250	180.0	8.4	2.47	2.3	1.25	4.0	8.0	Q3
TLV3605RVKR	WQFN	RVK	12	3000	330.0	12.4	3.3	3.3	1.1	8.0	12.0	Q2
TLV3605RVKT	WQFN	RVK	12	250	180.0	12.4	3.3	3.3	1.1	8.0	12.0	Q2

TAPE AND REEL BOX DIMENSIONS

*All dimensions are nominal

Device	Package Type	Package Drawing	Pins	SPQ	Length (mm)	Width (mm)	Height (mm)
TLV3604DCKR	SC70	DCK	6	3000	183.0	183.0	20.0
TLV3604DCKT	SC70	DCK	6	250	183.0	183.0	20.0
TLV3605RVKR	WQFN	RVK	12	3000	367.0	367.0	35.0
TLV3605RVKT	WQFN	RVK	12	250	210.0	185.0	35.0

DCK (R-PDSO-G6)

PLASTIC SMALL-OUTLINE PACKAGE



- NOTES:
- A. All linear dimensions are in millimeters.
 - B. This drawing is subject to change without notice.
 - C. Body dimensions do not include mold flash or protrusion. Mold flash and protrusion shall not exceed 0.15 per side.
 - D. Falls within JEDEC MO-203 variation AB.

DCK (R-PDSO-G6)

PLASTIC SMALL OUTLINE



- NOTES:
- A. All linear dimensions are in millimeters.
 - B. This drawing is subject to change without notice.
 - C. Customers should place a note on the circuit board fabrication drawing not to alter the center solder mask defined pad.
 - D. Publication IPC-7351 is recommended for alternate designs.
 - E. Laser cutting apertures with trapezoidal walls and also rounding corners will offer better paste release. Customers should contact their board assembly site for stencil design recommendations. Example stencil design based on a 50% volumetric metal load solder paste. Refer to IPC-7525 for other stencil recommendations.

MECHANICAL DATA

RVK (S-PWQFN-N12)

PLASTIC QUAD FLATPACK NO-LEAD

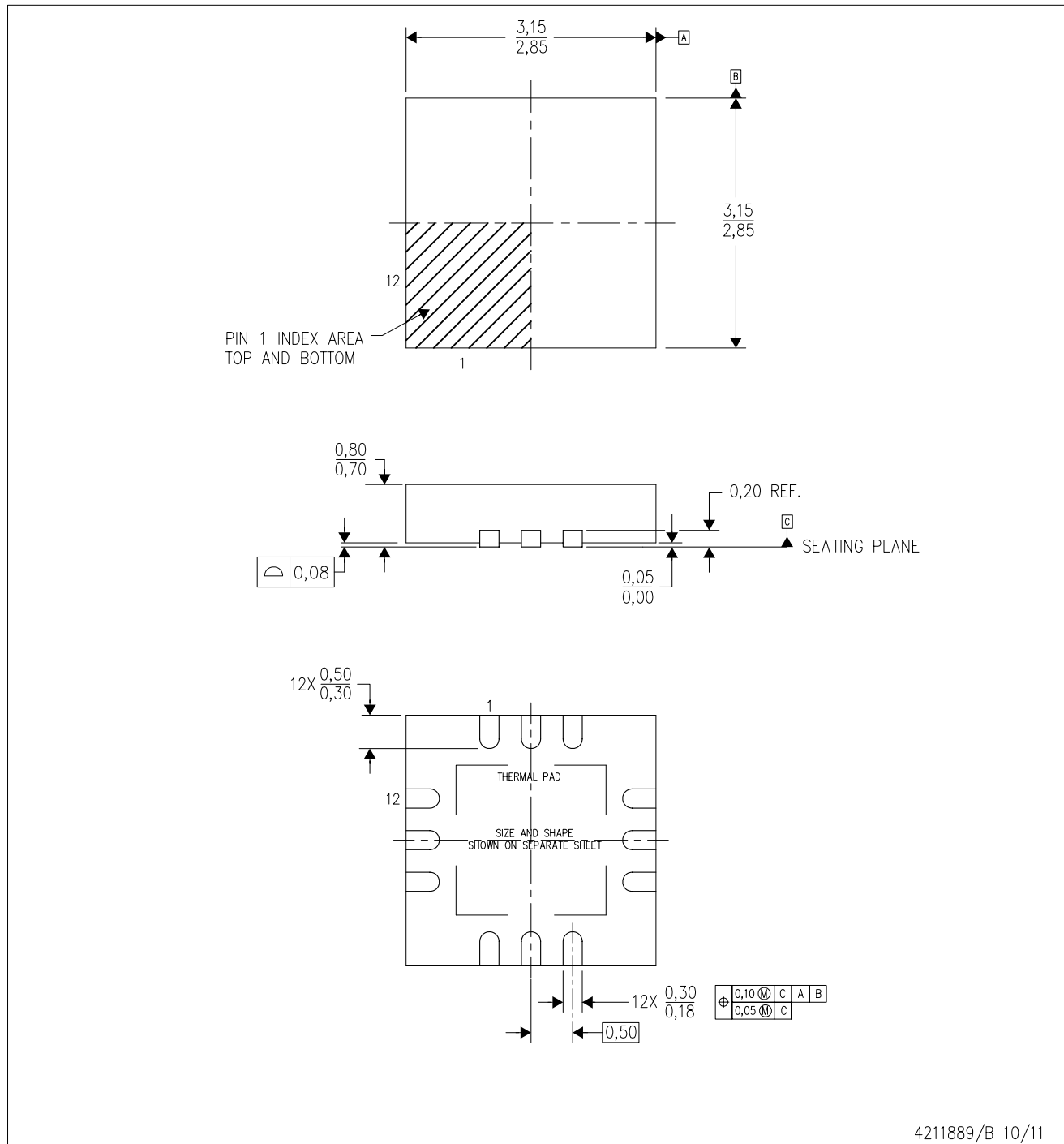

4211889/B 10/11

- NOTES:
- All linear dimensions are in millimeters. Dimensioning and tolerancing per ASME Y14.5M-1994.
 - This drawing is subject to change without notice.
 - Quad Flatpack, No-leads (QFN) package configuration.
 - The package thermal pad must be soldered to the board for thermal and mechanical performance.
 - See the additional figure in the Product Data Sheet for details regarding the exposed thermal pad features and dimensions.
 - Falls within JEDEC MO-220.

IMPORTANT NOTICE AND DISCLAIMER

TI PROVIDES TECHNICAL AND RELIABILITY DATA (INCLUDING DATA SHEETS), DESIGN RESOURCES (INCLUDING REFERENCE DESIGNS), APPLICATION OR OTHER DESIGN ADVICE, WEB TOOLS, SAFETY INFORMATION, AND OTHER RESOURCES "AS IS" AND WITH ALL FAULTS, AND DISCLAIMS ALL WARRANTIES, EXPRESS AND IMPLIED, INCLUDING WITHOUT LIMITATION ANY IMPLIED WARRANTIES OF MERCHANTABILITY, FITNESS FOR A PARTICULAR PURPOSE OR NON-INFRINGEMENT OF THIRD PARTY INTELLECTUAL PROPERTY RIGHTS.

These resources are intended for skilled developers designing with TI products. You are solely responsible for (1) selecting the appropriate TI products for your application, (2) designing, validating and testing your application, and (3) ensuring your application meets applicable standards, and any other safety, security, regulatory or other requirements.

These resources are subject to change without notice. TI grants you permission to use these resources only for development of an application that uses the TI products described in the resource. Other reproduction and display of these resources is prohibited. No license is granted to any other TI intellectual property right or to any third party intellectual property right. TI disclaims responsibility for, and you will fully indemnify TI and its representatives against, any claims, damages, costs, losses, and liabilities arising out of your use of these resources.

TI's products are provided subject to [TI's Terms of Sale](#) or other applicable terms available either on ti.com or provided in conjunction with such TI products. TI's provision of these resources does not expand or otherwise alter TI's applicable warranties or warranty disclaimers for TI products.

TI objects to and rejects any additional or different terms you may have proposed.

Mailing Address: Texas Instruments, Post Office Box 655303, Dallas, Texas 75265
Copyright © 2022, Texas Instruments Incorporated