

## N-channel 600 V, 0.26 $\Omega$ typ., 12 A MDmesh™ M6 Power MOSFET in a TO-220FP package

Datasheet - production data

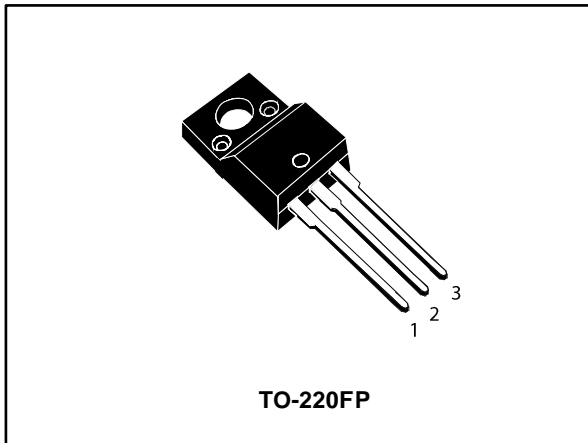
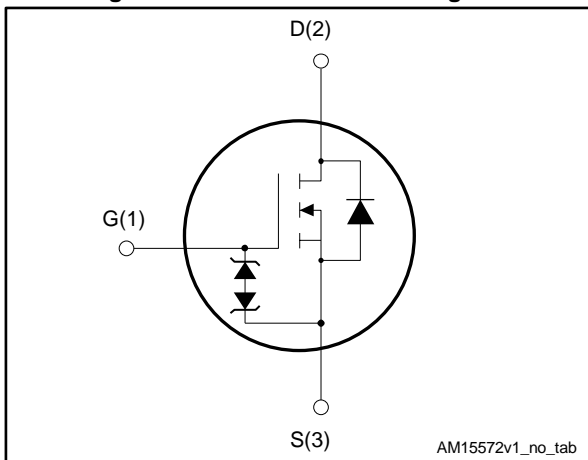

Figure 1: Internal schematic diagram



### Features

Order code	V <sub>DS</sub>	R <sub>DS(on)</sub> max.	I <sub>D</sub>
STF16N60M6	600 V	0.32 $\Omega$	12 A

- Reduced switching losses
- Lower R<sub>DS(on)</sub> x area vs previous generation
- Low gate input resistance
- 100% avalanche tested
- Zener-protected

### Applications

- Switching applications
- LLC converters
- Boost PFC converters

### Description

The new MDmesh™ M6 technology incorporates the most recent advancements to the well-known and consolidated MDmesh family of SJ MOSFETs. STMicroelectronics builds on the previous generation of MDmesh devices through its new M6 technology, which combines excellent R<sub>DS(on)</sub> \* area improvement with one of the most effective switching behaviors available, as well as a user-friendly experience for maximum end-application efficiency.

Table 1: Device summary

Order code	Marking	Package	Packing
STF16N60M6	16N60M6	TO-220FP	Tube

---

## Contents

<b>1</b>	<b>Electrical ratings .....</b>	<b>3</b>
<b>2</b>	<b>Electrical characteristics .....</b>	<b>4</b>
	2.1 Electrical characteristics (curves).....	6
<b>3</b>	<b>Test circuits .....</b>	<b>8</b>
<b>4</b>	<b>Package information .....</b>	<b>9</b>
	4.1 TO-220FP package information .....	10
<b>5</b>	<b>Revision history .....</b>	<b>12</b>

# 1 Electrical ratings

**Table 2: Absolute maximum ratings**

Symbol	Parameter	Value	Unit
V <sub>GS</sub>	Gate-source voltage	±25	V
I <sub>D</sub>	Drain current (continuous) at T <sub>c</sub> = 25 °C	12 <sup>(1)</sup>	A
I <sub>D</sub>	Drain current (continuous) at T <sub>c</sub> = 100 °C	7.6 <sup>(1)</sup>	A
I <sub>DM</sub>	Drain current (pulsed)	32 <sup>(1)(2)</sup>	A
P <sub>TOT</sub>	Total dissipation at T <sub>c</sub> = 25 °C	25	W
dv/dt <sup>(3)</sup>	Peak diode recovery voltage slope	15	V/ns
dv/dt <sup>(4)</sup>	MOSFET dv/dt ruggedness	50	
V <sub>ISO</sub>	Insulation withstand voltage (RMS) from all three leads to external heat sink (t = 1 s; T <sub>c</sub> = 25 °C)	2.5	kV
T <sub>stg</sub>	Storage temperature range	-55 to 150	°C
T <sub>j</sub>	Operating junction temperature range		

**Notes:**

(1) Limited by maximum junction temperature.

(2) Pulse width limited by safe operating area.

(3) I<sub>SD</sub> ≤ 12 A, di/dt ≤ 400 A/μs; V<sub>DS(peak)</sub> < V<sub>(BR)DSS</sub>, V<sub>DD</sub> = 400 V

(4) V<sub>DS</sub> ≤ 480 V

**Table 3: Thermal data**

Symbol	Parameter	Value	Unit
R <sub>thj-case</sub>	Thermal resistance junction-case	5	°C/W
R <sub>thj-amb</sub>	Thermal resistance junction-ambient	62.5	

**Table 4: Avalanche characteristics**

Symbol	Parameter	Value	Unit
I <sub>AR</sub>	Avalanche current, repetitive or not repetitive (pulse width limited by T <sub>jmax</sub> )	2.5	A
E <sub>AS</sub>	Single pulse avalanche energy (starting T <sub>j</sub> = 25 °C, I <sub>D</sub> = I <sub>AR</sub> ; V <sub>DD</sub> = 50 V)	110	mJ

## 2 Electrical characteristics

( $T_C = 25\text{ °C}$  unless otherwise specified)

**Table 5: On /off states**

Symbol	Parameter	Test conditions	Min.	Typ.	Max.	Unit
$V_{(BR)DSS}$	Drain-source breakdown voltage	$V_{GS} = 0\text{ V}$ , $I_D = 1\text{ mA}$	600			V
$I_{DSS}$	Zero gate voltage drain current	$V_{GS} = 0\text{ V}$ , $V_{DS} = 600\text{ V}$			1	$\mu\text{A}$
		$V_{GS} = 0\text{ V}$ , $V_{DS} = 600\text{ V}$ , $T_C = 125\text{ °C}$ <sup>(1)</sup>			100	
$I_{GSS}$	Gate-body leakage current	$V_{DS} = 0\text{ V}$ , $V_{GS} = \pm 25\text{ V}$			$\pm 5$	$\mu\text{A}$
$V_{GS(th)}$	Gate threshold voltage	$V_{DS} = V_{GS}$ , $I_D = 250\text{ }\mu\text{A}$	3.25	4	4.75	V
$R_{DS(on)}$	Static drain-source on-resistance	$V_{GS} = 10\text{ V}$ , $I_D = 6\text{ A}$		0.26	0.32	$\Omega$

**Notes:**

<sup>(1)</sup> Defined by design, not subject to production test.

**Table 6: Dynamic**

Symbol	Parameter	Test conditions	Min.	Typ.	Max.	Unit
$C_{iss}$	Input capacitance	$V_{GS} = 100\text{ V}$ , $f = 1\text{ MHz}$ , $V_{GS} = 0\text{ V}$	-	575	-	$\text{pF}$
$C_{oss}$	Output capacitance		-	33	-	
$C_{rss}$	Reverse transfer capacitance		-	3	-	
$C_{oss\text{ eq.}}^{(1)}$	Equivalent output capacitance	$V_{DS} = 0\text{ to }480\text{ V}$ , $V_{GS} = 0\text{ V}$	-	104	-	$\text{pF}$
$R_G$	Intrinsic gate resistance	$f = 1\text{ MHz}$ open drain	-	5.2	-	$\Omega$
$Q_g$	Total gate charge	$V_{DD} = 480\text{ V}$ , $I_D = 12\text{ A}$ , $V_{GS} = 0$ to $10\text{ V}$ (see <a href="#">Figure 15: "Test circuit for blue charge behavior"</a> )	-	16.7	-	$\text{nC}$
$Q_{gs}$	Gate-source charge		-	3.5	-	
$Q_{gd}$	Gate-drain charge		-	9.4	-	

**Notes:**

<sup>(1)</sup>  $C_{oss\text{ eq.}}$  is defined as a constant equivalent capacitance giving the same charging time as  $C_{oss}$  when  $V_{DS}$  increases from 0 to 80%  $V_{DSS}$ .

**Table 7: Switching times**

Symbol	Parameter	Test conditions	Min.	Typ.	Max.	Unit
$t_{d(on)}$	Turn-on delay time	$V_{DD} = 300\text{ V}$ , $I_D = 6\text{ A}$ $R_G = 4.7\text{ }\Omega$ , $V_{GS} = 10\text{ V}$ (see <a href="#">Figure 14: "Test circuit for resistive load switching times"</a> and <a href="#">Figure 19: "Switching time waveform"</a> )	-	13	-	$\text{ns}$
$t_r$	Rise time		-	7.6	-	
$t_{d(off)}$	Turn-off delay time		-	19.8	-	
$t_f$	Fall time		-	6.8	-	

Table 8: Source drain diode

Symbol	Parameter	Test conditions	Min.	Typ.	Max.	Unit
$I_{SD}$	Source-drain current		-		12	A
$I_{SDM}^{(1)}$	Source-drain current (pulsed)		-		32	A
$V_{SD}^{(2)}$	Forward on voltage	$V_{GS} = 0\text{ V}$ , $I_{SD} = 12\text{ A}$	-		1.6	V
$t_{rr}$	Reverse recovery time	$I_{SD} = 12\text{ A}$ , $di/dt = 100\text{ A}/\mu\text{s}$ , $V_{DD} = 60\text{ V}$ (see <a href="#">Figure 16</a> : "Test circuit for inductive load switching and diode recovery times")	-	210		ns
$Q_{rr}$	Reverse recovery charge		-	1.7		$\mu\text{C}$
$I_{RRM}$	Reverse recovery current		-	13.8		A
$t_{rr}$	Reverse recovery time	$I_{SD} = 12\text{ A}$ , $di/dt = 100\text{ A}/\mu\text{s}$ , $V_{DD} = 60\text{ V}$ , $T_j = 150\text{ }^\circ\text{C}$ (see <a href="#">Figure 16</a> : "Test circuit for inductive load switching and diode recovery times")	-	310		ns
$Q_{rr}$	Reverse recovery charge		-	3.2		$\mu\text{C}$
$I_{RRM}$	Reverse recovery current		-	15.4		A

**Notes:**

- (1) Pulse width is limited by safe operating area.  
(2) Pulse test: pulse duration = 300  $\mu\text{s}$ , duty cycle 1.5%.

## 2.1 Electrical characteristics (curves)

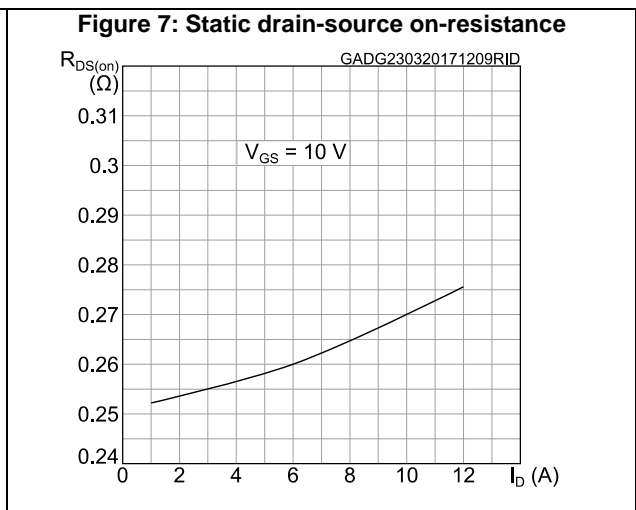
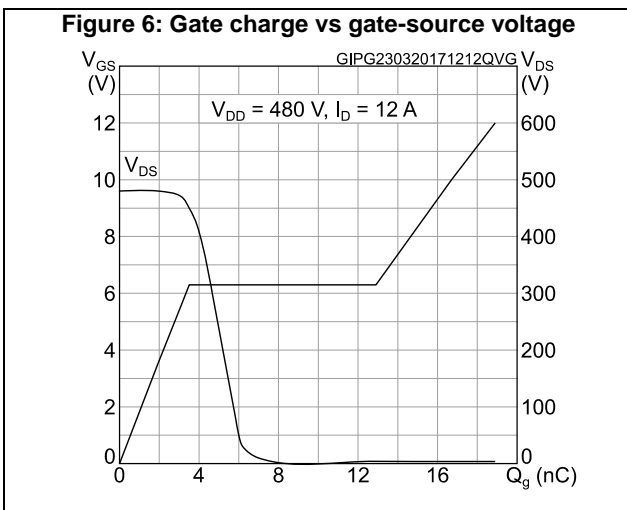
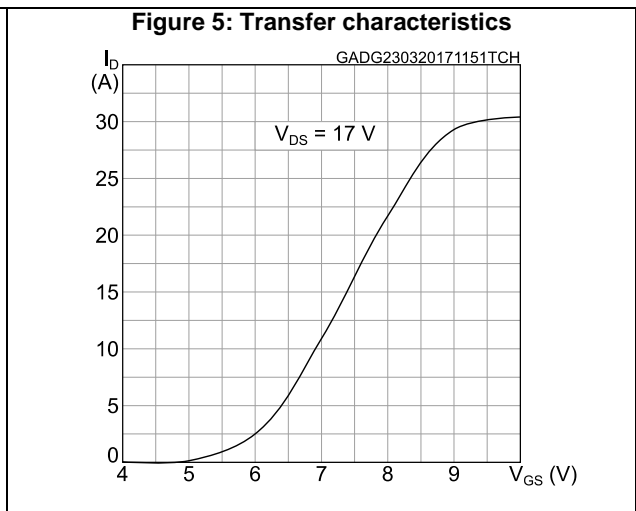
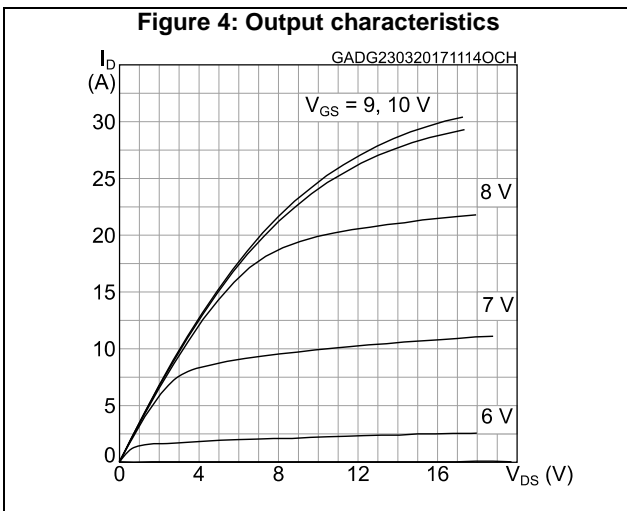
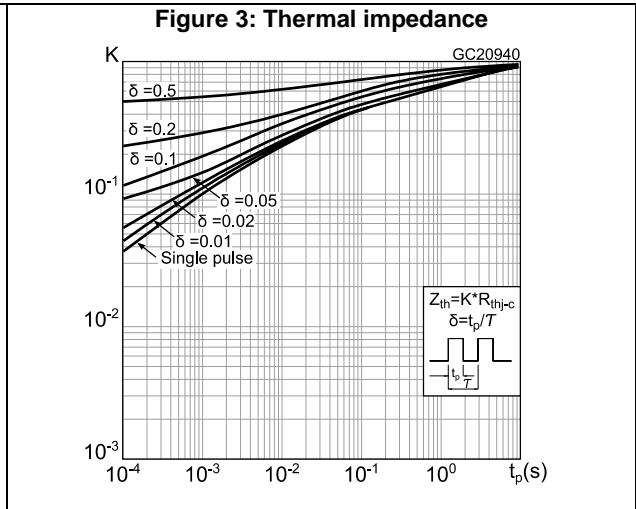
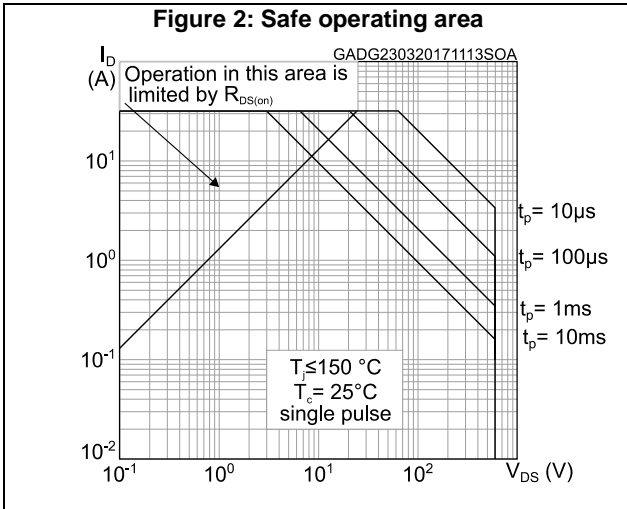

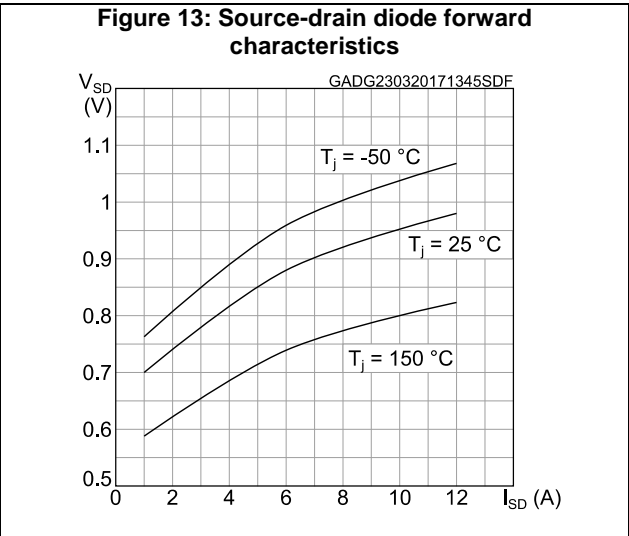
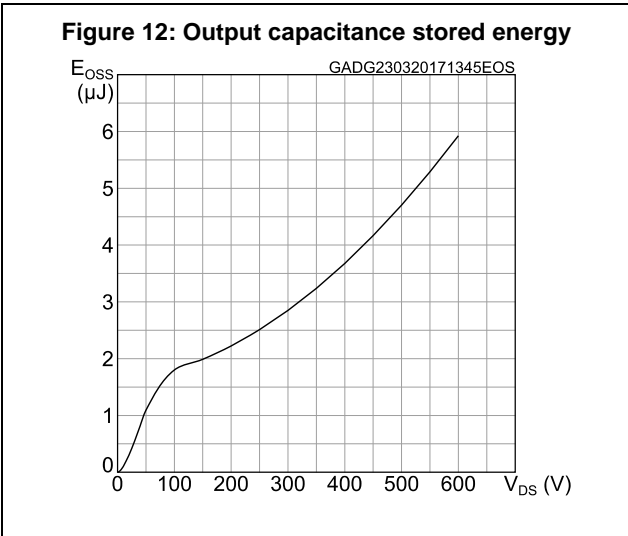
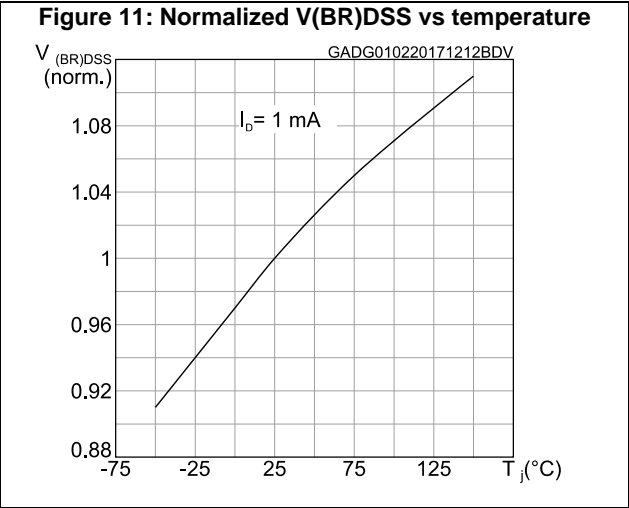
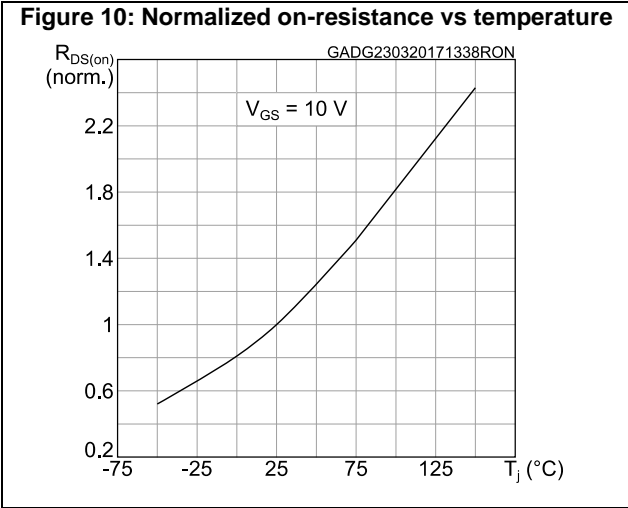
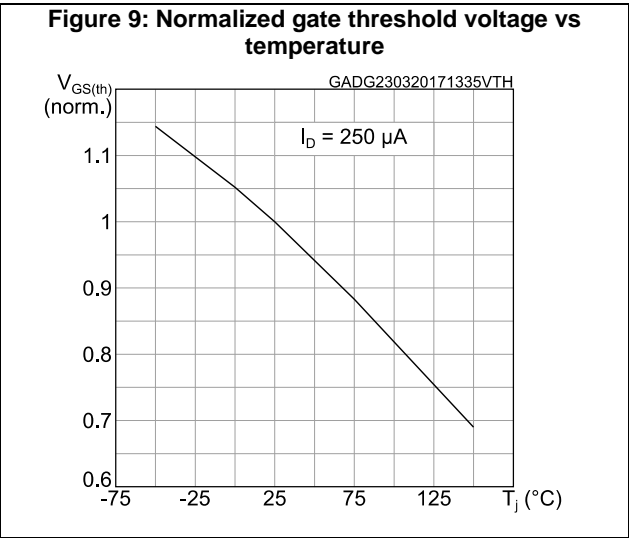
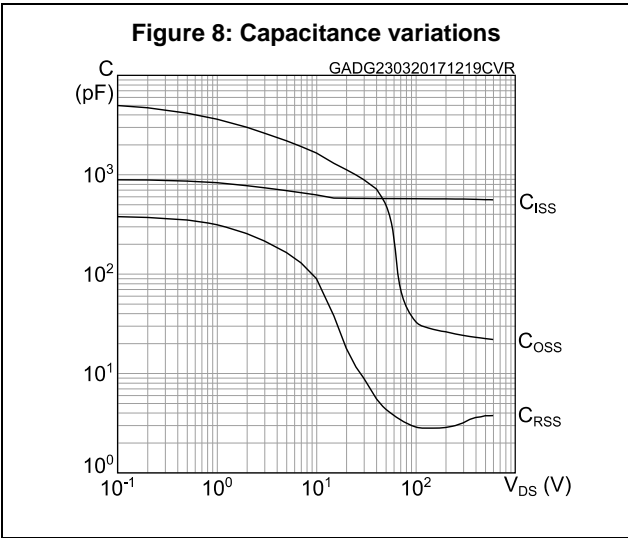

### 3 Test circuits

**Figure 14: Test circuit for resistive load switching times**

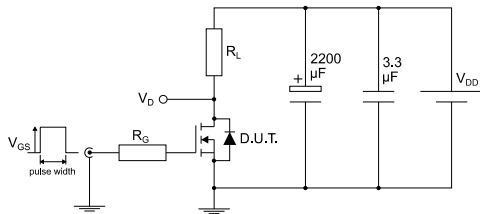

AM01468v1

**Figure 15: Test circuit for gate charge behavior**

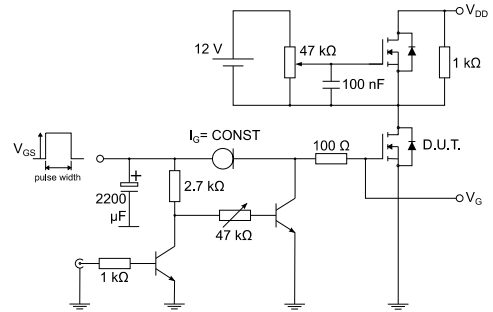

AM01469v1

**Figure 16: Test circuit for inductive load switching and diode recovery times**

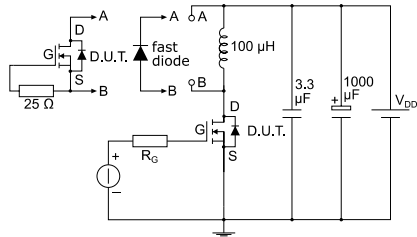

AM01470v1

**Figure 17: Unclamped inductive load test circuit**

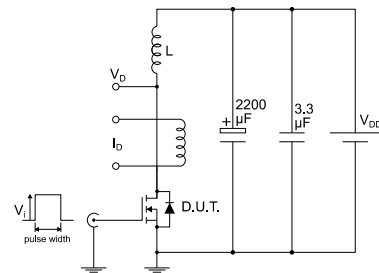

AM01471v1

**Figure 18: Unclamped inductive waveform**

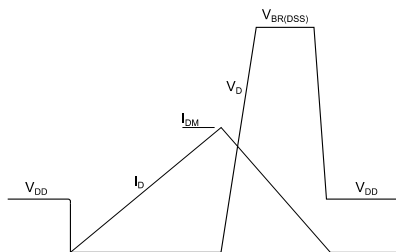

AM01472v1

**Figure 19: Switching time waveform**

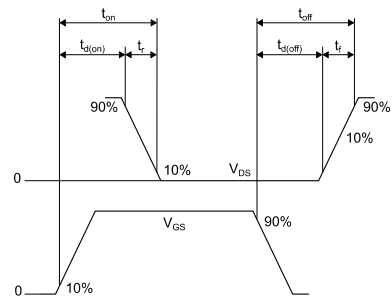

AM01473v1



## 4 Package information

In order to meet environmental requirements, ST offers these devices in different grades of ECOPACK® packages, depending on their level of environmental compliance. ECOPACK® specifications, grade definitions and product status are available at: [www.st.com](http://www.st.com). ECOPACK® is an ST trademark.

### 4.1 TO-220FP package information

Figure 20: TO-220FP package outline

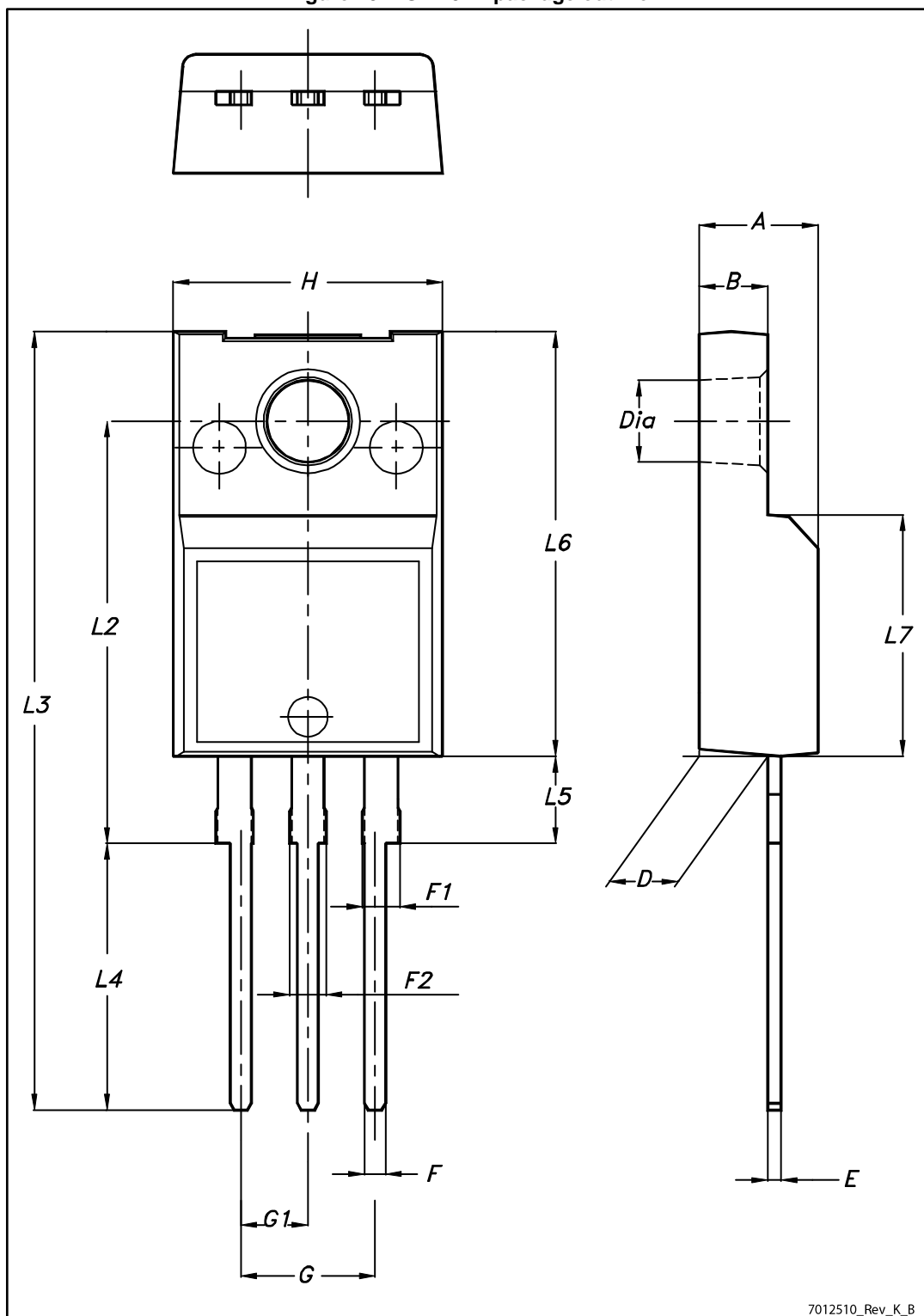

7012510\_Rev\_K\_B

Table 9: TO-220FP package mechanical data

Dim.	mm		
	Min.	Typ.	Max.
A	4.4		4.6
B	2.5		2.7
D	2.5		2.75
E	0.45		0.7
F	0.75		1
F1	1.15		1.70
F2	1.15		1.70
G	4.95		5.2
G1	2.4		2.7
H	10		10.4
L2		16	
L3	28.6		30.6
L4	9.8		10.6
L5	2.9		3.6
L6	15.9		16.4
L7	9		9.3
Dia	3		3.2

## 5 Revision history

Table 10: Document revision history

Date	Revision	Changes
23-Mar-2017	1	First release.

**IMPORTANT NOTICE – PLEASE READ CAREFULLY**

STMicroelectronics NV and its subsidiaries ("ST") reserve the right to make changes, corrections, enhancements, modifications, and improvements to ST products and/or to this document at any time without notice. Purchasers should obtain the latest relevant information on ST products before placing orders. ST products are sold pursuant to ST's terms and conditions of sale in place at the time of order acknowledgement.

Purchasers are solely responsible for the choice, selection, and use of ST products and ST assumes no liability for application assistance or the design of Purchasers' products.

No license, express or implied, to any intellectual property right is granted by ST herein.

Resale of ST products with provisions different from the information set forth herein shall void any warranty granted by ST for such product.

ST and the ST logo are trademarks of ST. All other product or service names are the property of their respective owners.

Information in this document supersedes and replaces information previously supplied in any prior versions of this document.

© 2017 STMicroelectronics – All rights reserved