

# BQ25171-Q1: Automotive, Standalone 800-mA Linear Battery Charger for 1- to 2-Cell Li-Ion, LiFePO<sub>4</sub>, and 1- to 6-Cell NiMH

## 1 Features

- AEC-Q100 qualified for automotive applications
  - Temperature grade 1:  $-40^{\circ}\text{C} \leq T_A \leq 125^{\circ}\text{C}$
  - HBM ESD classification level 2
  - CDM ESD classification level C4B
- 40-V load-dump tolerant to support charging back-up battery directly from main battery, 3-V to 18-V operating
- Automatic Sleep Mode for low power consumption
  - 350-nA battery leakage current
  - 2- $\mu\text{A}$  input leakage current when charge disabled
- Support multi-chemistry battery
  - 1- to 2-cell Li-Ion, Li-Poly, and LiFePO<sub>4</sub>
  - 1- to 6-cell NiMH with intermittent-charging support
- External resistor programmable operation
  - VSET to set battery regulation voltage from 3.5 V to 8.4 V for Li-Ion, or 1- to 6-cell for NiMH
  - ISET to set charge current from 10 mA to 800 mA
  - CHM\_TMR to set battery chemistry as Li+ or NiMH, and charge timer duration
- High accuracy
  - $\pm 0.5\%$  charge voltage accuracy
  - $\pm 10\%$  charge current accuracy
- Charging features
  - Precharge current 20% of ISET
  - Termination current 10% of ISET
  - NTC thermistor input to monitor battery temperature
  - $\overline{\text{CE}}$  pin for charging function control
  - Two Open-drain output for status and fault indication
- Integrated fault protection
  - 18-V IN overvoltage protection
  - VSET based OUT overvoltage protection
  - 1000-mA overcurrent protection
  - 125°C thermal regulation; 150°C thermal shutdown protection
  - OUT short-circuit protection
  - VSET, ISET, CHM\_TMR pins short/open protection

## 3 Description

The BQ25171-Q1 is an automotive rated, 800-mA linear charger for 1-cell and 2-cell Li-Ion, Li-Polymer, and LiFePO<sub>4</sub>, in addition to 1-cell up to 6-cell NiMH battery applications. The device has a single power output that charges the battery. The system load can be placed in parallel with the battery, as long as the average system load does not prevent the battery from charging fully within the safety timer duration. When the system load is placed in parallel with the battery, the charge current is shared between the system and the battery.

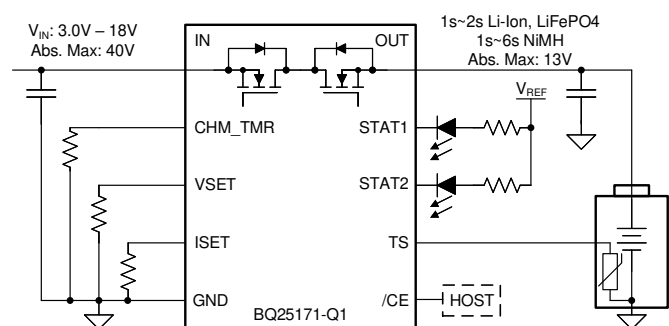
The device has three phases for charging a Li-Ion battery: precharge to recover a fully discharged battery, fast-charge constant current to supply the bulk of the charge, and voltage regulation to reach full capacity.

The device charges a NiMH in constant current mode only, and terminates the charge cycle when the programmable timer expires or the battery voltage exceeds the VOUT\_OVP threshold. In all charge phases, an internal control loop monitors the IC junction temperature and reduces the charge current if an internal temperature threshold, T<sub>REG</sub>, is exceeded.

### Device Information

PART NUMBER <sup>(1)</sup>	PACKAGE	BODY SIZE (NOM)
BQ25171-Q1	VSON (10)	3.0 mm x 3.0 mm

(1) For all available packages, see the orderable addendum at the end of the data sheet.



**Simplified Schematic**

## 2 Applications

- [Telematics control unit \(TCU\)](#)
- [Emergency call \(eCall\)](#)
- [Fleet management, asset tracking](#)
- [Remote keyless entry \(RKE\) keyfob](#)



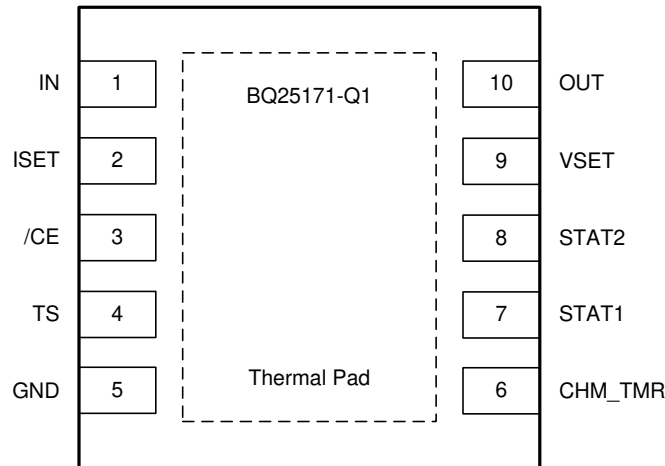
## Table of Contents

<b>1 Features</b> .....	1	7.4 Device Functional Modes.....	23
<b>2 Applications</b> .....	1	<b>8 Application and Implementation</b> .....	25
<b>3 Description</b> .....	1	8.1 Application Information.....	25
<b>4 Revision History</b> .....	2	8.2 Typical Applications.....	25
<b>5 Pin Configuration and Functions</b> .....	3	<b>9 Power Supply Recommendations</b> .....	31
<b>6 Specifications</b> .....	4	<b>10 Layout</b> .....	31
6.1 Absolute Maximum Ratings .....	4	10.1 Layout Guidelines.....	31
6.2 ESD Ratings .....	4	10.2 Layout Example.....	31
6.3 Recommended Operating Conditions .....	4	<b>11 Device and Documentation Support</b> .....	32
6.4 Thermal Information .....	5	11.1 Device Support.....	32
6.5 Electrical Characteristics .....	6	11.2 Receiving Notification of Documentation Updates..	32
6.6 Timing Requirements .....	8	11.3 Support Resources.....	32
6.7 Typical Characteristics.....	9	11.4 Trademarks.....	32
<b>7 Detailed Description</b> .....	12	11.5 Electrostatic Discharge Caution.....	32
7.1 Overview.....	12	11.6 Glossary.....	32
7.2 Functional Block Diagram.....	14	<b>12 Mechanical, Packaging, and Orderable Information</b> .....	33
7.3 Feature Description.....	15		

## 4 Revision History

Changes from Revision * (August 2020) to Revision A (March 2021)	Page
• Changed from Advance Information to Production Data.....	1

## 5 Pin Configuration and Functions



**Figure 5-1. VSON Package 10-Pin (Top View)**

**Table 5-1. Pin Functions**

PIN		I/O	DESCRIPTION
NAME	NUMBER		
IN	1	P	Input power, connected to external DC supply. Bypass IN with at least 1- $\mu$ F capacitor to GND, placed close to the IC.
ISET	2	I	Programs the fast-charge current setting. External resistor from ISET to GND defines fast-charge current value. Recommended range is 30 k $\Omega$ (10 mA) to 375 $\Omega$ (800 mA). $ICHG = K_{ISET} / R_{ISET}$ . Precharge current is defined as 20% of ICHG. Termination current is defined as 10% of ICHG.
$\overline{CE}$	3	I	Active Low Charge Enable pin. Battery charging is enabled when $\overline{CE}$ pin is low. IC remains in Shutdown Mode and battery charging is disabled when $\overline{CE}$ pin is high. An internal pulldown resistor ( $R_{PD\_CE}$ ) enables the IC by default if this pin is floating.
TS	4	I	Temperature Qualification Voltage Input. Connect a negative temperature coefficient (NTC) thermistor directly from TS to GND (AT103-2 recommended). Charge suspends when the TS pin voltage is out of range. If TS function is not needed, connect an external 10-k $\Omega$ resistor from TS to GND.
GND	5	–	Ground pin
CHM_TMR	6	I	Programs the chemistry and charge time to be used with a pull-down resistor. Valid resistor range is 3.6 k $\Omega$ to 100 k $\Omega$ , values outside this range will suspend charge. Refer to <a href="#">Section 7.3.1.2</a> for voltage level details.
STAT1	7	O	Open drain charge status 1 output. Connect to pullup rail via 10-k $\Omega$ resistor.
STAT2	8	O	Open drain charge status 2 output. Connect to pullup rail via 10-k $\Omega$ resistor.
VSET	9	I	Programs the regulation voltage for OUT pin with a pull-down resistor. Valid resistor range is 3.6 k $\Omega$ to 100 k $\Omega$ , values outside this range will suspend charge. Refer to <a href="#">Section 7.3.1.3</a> for voltage level details.
OUT	10	P	Battery Connection. System load may be connected in parallel to battery. Bypass OUT with at least 1- $\mu$ F capacitor to GND, placed close to the IC.
Thermal Pad	—	—	Exposed pad beneath the IC for heat dissipation. Solder thermal pad to the board with vias connecting to solid GND plane.

## 6 Specifications

### 6.1 Absolute Maximum Ratings

over operating free-air temperature range (unless otherwise noted)<sup>(1)</sup>

		MIN	MAX	UNIT
Voltage	IN	-0.3	40	V
Voltage	OUT	-0.3	13	V
Voltage	$\overline{CE}$ , CHM_TMR, ISET, STAT1, STAT2, TS, VSET	-0.3	5.5	V
Output Sink Current	STAT1, STAT2		5	mA
T <sub>J</sub>	Junction temperature	-40	150	°C
T <sub>stg</sub>	Storage temperature	-65	150	°C

- (1) Stresses beyond those listed under *Absolute Maximum Rating* may cause permanent damage to the device. These are stress ratings only, which do not imply functional operation of the device at these or any other conditions beyond those indicated under *Recommended Operating Condition*. Exposure to absolute-maximum-rated conditions for extended periods may affect device reliability.

### 6.2 ESD Ratings

			VALUE	UNIT	
V <sub>(ESD)</sub>	Electrostatic discharge	Human body model (HBM), per AEC Q100-002 <sup>(1)</sup>	±2000	V	
		Charged device model (CDM), per AEC Q100-011	Corner pins (IN, GND, CHM_TMR, OUT)		±750
			Other pins		±500

- (1) AEC Q100-002 indicates that HBM stressing shall be in accordance with the ANSI/ESDA/JEDEC JS-001 specification.

### 6.3 Recommended Operating Conditions

over operating free-air temperature range (unless otherwise noted)

		MIN	NOM	MAX	UNIT
V <sub>IN</sub>	Input voltage	3.0		18	V
V <sub>OUT</sub>	Output voltage			10.5	V
I <sub>OUT</sub>	Output current			0.8	A
T <sub>J</sub>	Junction temperature	-40		125	°C
C <sub>IN</sub>	IN capacitor	1			μF
C <sub>OUT</sub>	OUT capacitor	1			μF
R <sub>CHM_TMR</sub>	CHM_TMR resistor	3.6		100	kΩ
R <sub>VSET</sub>	VSET resistor	3.6		100	kΩ
R <sub>VSET_CHM_TMR_TOL</sub>	Tolerance for VSET, and CHM_TMR, resistors	-1		1	%
R <sub>VSET_CHM_TMR_TEMPCO</sub>	Temperature coefficient for VSET, and CHM_TMR resistors			200	ppm/°C
R <sub>ISET</sub>	ISET resistor	0.375		30	kΩ
R <sub>TS</sub>	TS thermistor resistor (recommend 103AT-2)		10		kΩ

## 6.4 Thermal Information

THERMAL METRIC <sup>(1)</sup>		BQ25171-Q1	
		DRC	
		10 PINS	
			UNIT
$R_{\theta JA}$	Junction-to-ambient thermal resistance (EVM <sup>(2)</sup> )	37	°C/W
$R_{\theta JA}$	Junction-to-ambient thermal resistance (JEDEC <sup>(1)</sup> )	60.3	°C/W
$R_{\theta JC(top)}$	Junction-to-case (top) thermal resistance	73.1	°C/W
$R_{\theta JB}$	Junction-to-board thermal resistance	34.2	°C/W
$\Psi_{JT}$	Junction-to-top characterization parameter	6.0	°C/W
$\Psi_{JB}$	Junction-to-board characterization parameter	34.2	°C/W
$R_{\theta JC(bot)}$	Junction-to-case (bottom) thermal resistance	16.7	°C/W

- (1) For more information about traditional and new thermal metrics, see the [Semiconductor and IC Package Thermal Metrics](#) application report.
- (2) 1oz Copper, 2-layer board

## 6.5 Electrical Characteristics

3.0V < V<sub>IN</sub> < 18V and V<sub>IN</sub> > V<sub>OUT</sub> + V<sub>SLEEP</sub>, T<sub>J</sub> = -40°C to +125°C, and T<sub>J</sub> = 25°C for typical values (unless otherwise noted)

PARAMETER		TEST CONDITIONS	MIN	TYP	MAX	UNIT
<b>QUIESCENT CURRENTS</b>						
I <sub>Q_OUT</sub>	Quiescent output current (OUT)	OUT = 4.2V, IN floating or IN = 0V - 5V, Charge Disabled ( $\overline{CE}$ high), T <sub>J</sub> = 25 °C		0.350	0.6	μA
		OUT = 4.2V, IN floating or IN = 0V - 5V, Charge Disabled ( $\overline{CE}$ high), T <sub>J</sub> < 105 °C		0.350	0.8	μA
I <sub>Q_OUT</sub>	Quiescent output current (OUT)	OUT = 8.4V, IN floating or IN = 0V - 14V, Charge Disabled ( $\overline{CE}$ high), T <sub>J</sub> = 25 °C		0.8	1.2	μA
		OUT = 8.4V, IN floating or IN = 0V - 14V, Charge Disabled ( $\overline{CE}$ high), T <sub>J</sub> < 105 °C		0.8	1.5	μA
I <sub>SD_IN</sub>	Shutdown input current (IN) with charge disabled	IN = 5V, Charge Disabled ( $\overline{CE}$ high), no battery		2	4	μA
		IN = 14V, Charge Disabled ( $\overline{CE}$ high), no battery		3.5	6	μA
I <sub>STANDBY_IN</sub>	Standby input current (IN) with charge terminated	IN = 5V, Charge Enabled ( $\overline{CE}$ low), charge terminated		190		μA
I <sub>STANDBY_IN</sub>	Standby input current (IN) with charge terminated	IN = 14V, Charge Enabled ( $\overline{CE}$ low), charge terminated		230		μA
I <sub>Q_IN</sub>	Quiescent input current (IN)	IN = 5V, OUT = 3.8V, Charge Enabled ( $\overline{CE}$ low), ICHG = 0A		0.45	0.6	mA
I <sub>Q_IN</sub>	Quiescent input current (IN)	IN = 14V, OUT = 7.6V, Charge Enabled ( $\overline{CE}$ low), ICHG = 0A		0.45	0.6	mA
<b>INPUT</b>						
V <sub>IN_OP</sub>	IN operating range		3.0		18	V
V <sub>IN_LOWV</sub>	IN voltage to start charging	IN rising	3.05	3.09	3.15	V
V <sub>IN_LOWV</sub>	IN voltage to stop charging	IN falling	2.80	2.95	3.10	V
V <sub>SLEEPZ</sub>	Exit sleep mode threshold	IN rising, V <sub>IN</sub> - V <sub>OUT</sub> , OUT = 4V	95	135	175	mV
V <sub>SLEEP</sub>	Sleep mode threshold hysteresis	IN falling, V <sub>IN</sub> - V <sub>OUT</sub> , OUT = 4V		80		mV
V <sub>IN_OV</sub>	VIN overvoltage rising threshold	IN rising	18.1	18.4	18.7	V
V <sub>IN_OVZ</sub>	VIN overvoltage falling threshold	IN falling		18.2		V
<b>CONFIGURATION PINS SHORT/OPEN PROTECTION</b>						
R <sub>ISET_SHORT</sub>	Highest resistor value considered short	R <sub>ISET</sub> below this at startup, charger does not initiate charge, power cycle or $\overline{CE}$ toggle to reset			350	Ω
R <sub>VSET_SHORT</sub>	Highest resistor value considered short	R <sub>VSET</sub> below this at startup, charger does not initiate charge, power cycle or $\overline{CE}$ toggle to reset			2.8	kΩ
R <sub>VSET_OPEN</sub>	Lowest resistor value considered open	R <sub>VSET</sub> above this at startup, charger does not initiate charge, power cycle or $\overline{CE}$ toggle to reset	120			kΩ
R <sub>CHM_TMR_SHORT</sub>	Highest resistor value considered short	R <sub>CHM_TMR</sub> below this at startup, charger latches off, power cycle or $\overline{CE}$ toggle to reset			2.8	kΩ
R <sub>CHM_TMR_OPEN</sub>	Lowest resistor value considered open	R <sub>CHM_TMR</sub> above this at startup, charger latches off, power cycle or $\overline{CE}$ toggle to reset	120			kΩ
<b>BATTERY CHARGER</b>						
V <sub>DO</sub>	Dropout voltage (V <sub>IN</sub> - V <sub>OUT</sub> )	V <sub>IN</sub> falling, V <sub>OUT</sub> = 4.35V, I <sub>OUT</sub> = 500mA		425		mV
V <sub>REG_ACC</sub>	OUT charge voltage regulation accuracy	T <sub>J</sub> = 25°C, all VSET settings	-0.5		0.5	%
		T <sub>J</sub> = -40°C to 125°C, all VSET settings	-0.8		0.8	%

## 6.5 Electrical Characteristics (continued)

3.0V < V<sub>IN</sub> < 18V and V<sub>IN</sub> > V<sub>OUT</sub> + V<sub>SLEEP</sub>, T<sub>J</sub> = -40°C to +125°C, and T<sub>J</sub> = 25°C for typical values (unless otherwise noted)

PARAMETER		TEST CONDITIONS	MIN	TYP	MAX	UNIT
I <sub>CHG_RANGE</sub>	Typical charge current regulation range	V <sub>OUT</sub> > V <sub>BAT_LOWV</sub>	10		800	mA
K <sub>ISET</sub>	Charge current setting factor, I <sub>CHG</sub> = K <sub>ISET</sub> / R <sub>ISET</sub>	10mA < I <sub>CHG</sub> < 800mA	270	300	330	AΩ
I <sub>CHG_ACC</sub>	Charge current accuracy <sup>(1)</sup>	R <sub>ISET</sub> = 375Ω, OUT = 3.8V or 7.6V	720	800	880	mA
		R <sub>ISET</sub> = 600Ω, OUT = 3.8V or 7.6V	450	500	550	mA
		R <sub>ISET</sub> = 3.0kΩ, OUT = 3.8V or 7.6V	90	100	110	mA
		R <sub>ISET</sub> = 30kΩ, OUT = 3.8V or 7.6V	9	10	11	mA
I <sub>PRECHG</sub>	Typical pre-charge current, as percentage of I <sub>CHG</sub>	V <sub>OUT</sub> < V <sub>BAT_LOWV</sub>		20		%
I <sub>PRECHG_ACC</sub>	Precharge current accuracy	R <sub>ISET</sub> = 375Ω, OUT = 2.5V or 5.0V	144	160	176	mA
		R <sub>ISET</sub> = 600Ω, OUT = 2.5V or 5.0V	85	100	110	mA
		R <sub>ISET</sub> = 3.0kΩ, OUT = 2.5V or 5.0V	18	20	22	mA
		R <sub>ISET</sub> = 30kΩ, OUT = 2.5V or 5.0V	1.4	2	2.6	mA
I <sub>TERM</sub>	Typical termination current, as percentage of I <sub>CHG</sub>	V <sub>OUT</sub> = V <sub>REG</sub>		10		%
I <sub>TERM_ACC</sub>	Termination current accuracy	R <sub>ISET</sub> = 600Ω, OUT = V <sub>REG</sub> = 4.2V or 8.4V	45	50	55	mA
		R <sub>ISET</sub> = 3.0kΩ, OUT = V <sub>REG</sub> = 4.2V or 8.4V	8.5	10	11.5	mA
		R <sub>ISET</sub> = 30kΩ, OUT = V <sub>REG</sub> = 4.2V or 8.4V	0.4	1	1.6	mA
V <sub>BAT_SHORT</sub>	Output (OUT) short circuit voltage rising threshold, per cell for Li-Ion chemistry	OUT rising, VSET configured for Li-Ion , 1-cell or 2-cell	2.1	2.2	2.3	V
V <sub>BAT_SHORT</sub>	Output (OUT) short circuit voltage rising threshold, per cell for LiFePO <sub>4</sub> chemistry	OUT rising, VSET configured for LiFePO <sub>4</sub> , 1-cell or 2-cell	1.1	1.2	1.3	V
V <sub>BAT_SHORT_HYS</sub>	Output (OUT) short circuit voltage hysteresis, per cell	OUT falling		200		mV
I <sub>BAT_SHORT</sub>	OUT short circuit charging current	V <sub>OUT</sub> < V <sub>BAT_SHORT</sub>	12	16	20	mA
V <sub>BAT_LOWV</sub>	Pre-charge to fast-charge transition threshold, per cell for Li-Ion chemistry	OUT rising, VSET configured for Li-Ion , 1-cell or 2-cell	2.7	2.8	3.0	V
V <sub>BAT_LOWV</sub>	Pre-charge to fast-charge transition threshold, per cell for Li-FePO <sub>4</sub> chemistry	OUT rising, VSET configured for LiFePO <sub>4</sub> , 1-cell or 2-cell	1.9	2.0	2.1	V
V <sub>BAT_LOWV_HYS</sub>	Battery LOWV hysteresis, per cell	OUT falling, all charger configurations		100		mV
V <sub>RECHG</sub>	Battery recharge threshold, per cell for Li-Ion chemistry	OUT falling, VSET configured for Li-Ion , 1-cell or 2-cell, V <sub>REG_ACC</sub> - V <sub>OUT</sub>	75	100	125	mV
V <sub>RECHG</sub>	Battery recharge threshold, per cell for LiFePO <sub>4</sub> chemistry	OUT falling, VSET configured for LiFePO <sub>4</sub> , 1-cell or 2-cell, V <sub>REG_ACC</sub> - V <sub>OUT</sub>	175	200	225	mV
V <sub>RECHG</sub>	Battery recharge threshold, per cell for NiMH chemistry	OUT falling, VSET configured for 2-cell with intermittent charge enabled	1.305	1.330	1.355	V
R <sub>ON</sub>	Charging path FET on-resistance	IN > 5V, T <sub>J</sub> = 25°C		845	980	mΩ
		IN > 5V, T <sub>J</sub> = -40°C - 125°C		845	1350	mΩ
<b>BATTERY CHARGER PROTECTION</b>						
V <sub>OUT_OVP</sub>	OUT overvoltage rising threshold	V <sub>OUT</sub> rising, as percentage of V <sub>REG</sub>	103	104	105	%
V <sub>OUT_OVP</sub>	OUT overvoltage falling threshold	V <sub>OUT</sub> falling, as percentage of V <sub>REG</sub>	101	102	103	%
V <sub>OUT_OVP</sub>	OUT overvoltage rising threshold, per cell for NiMH chemistry	V <sub>OUT</sub> rising, TS normal	1.65	1.70	1.75	V
V <sub>OUT_OVP</sub>	OUT overvoltage falling threshold, per cell for NiMH chemistry	V <sub>OUT</sub> falling, TS normal	1.40	1.45	1.50	V
I <sub>OUT_OCP</sub>	Output current limit threshold	I <sub>OUT</sub> rising	0.9	1	1.1	A

## 6.5 Electrical Characteristics (continued)

$3.0V < V_{IN} < 18V$  and  $V_{IN} > V_{OUT} + V_{SLEEP}$ ,  $T_J = -40^{\circ}C$  to  $+125^{\circ}C$ , and  $T_J = 25^{\circ}C$  for typical values (unless otherwise noted)

PARAMETER		TEST CONDITIONS	MIN	TYP	MAX	UNIT
<b>TEMPERATURE REGULATION AND TEMPERATURE SHUTDOWN</b>						
$T_{REG}$	Typical junction temperature regulation			125		$^{\circ}C$
$T_{SHUT}$	Thermal shutdown rising threshold	Temperature increasing		150		$^{\circ}C$
	Thermal shutdown falling threshold	Temperature decreasing		135		$^{\circ}C$
<b>BATTERY-PACK NTC MONITOR</b>						
$I_{TS\_BIAS}$	TS nominal bias current		36.5	38	39.5	$\mu A$
$V_{COLD}$	Cold temperature threshold	TS pin voltage rising (approx. $0^{\circ}C$ )	0.99	1.04	1.09	V
	Cold temperature exit threshold	TS pin voltage falling (approx. $4^{\circ}C$ )	0.83	0.88	0.93	V
$V_{HOT}$	Hot temperature threshold	TS pin voltage falling (approx. $45^{\circ}C$ )	176	188	200	mV
	Hot temperature exit threshold	TS pin voltage rising (approx. $40^{\circ}C$ )	208	220	232	mV
$V_{TS\_CLAMP}$	TS maximum voltage clamp	TS pin open-circuit (float)	2.3	2.6	2.9	V
<b>LOGIC INPUT PIN (/CE)</b>						
$V_{IH}$	Input high threshold level		1.3			V
$V_{IL}$	Input low threshold level				0.4	V
$R_{PD\_CE}$	$\overline{CE}$ pin internal pulldown resistor		3.3			$M\Omega$
<b>LOGIC OUTPUT PIN (STAT1, STAT2)</b>						
$V_{OL}$	Output low threshold level	Sink current = 5mA			0.4	V
$I_{OUT\_BIAS}$	High-level leakage current	Pull up rail 3.3V			1	$\mu A$

(1) Temperature Regulation (TREG) loop may reduce the output current depending on power dissipation and ambient temperature

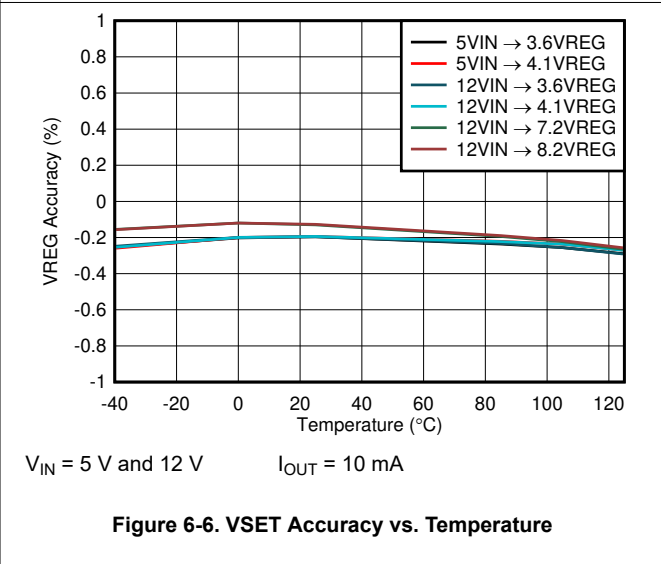
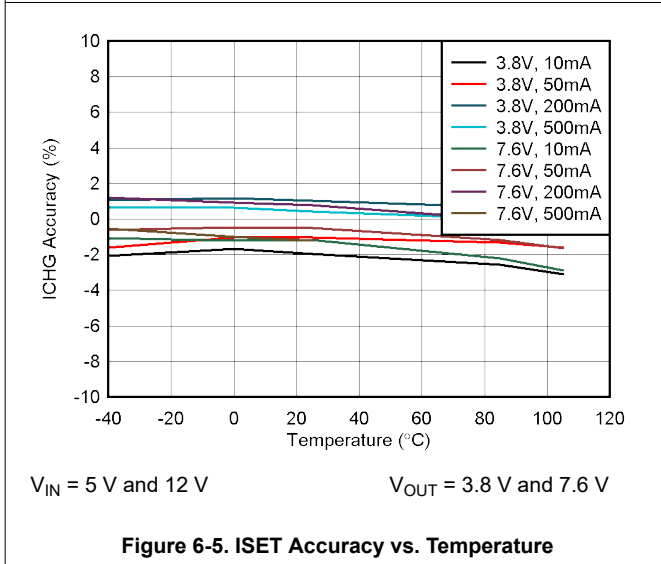
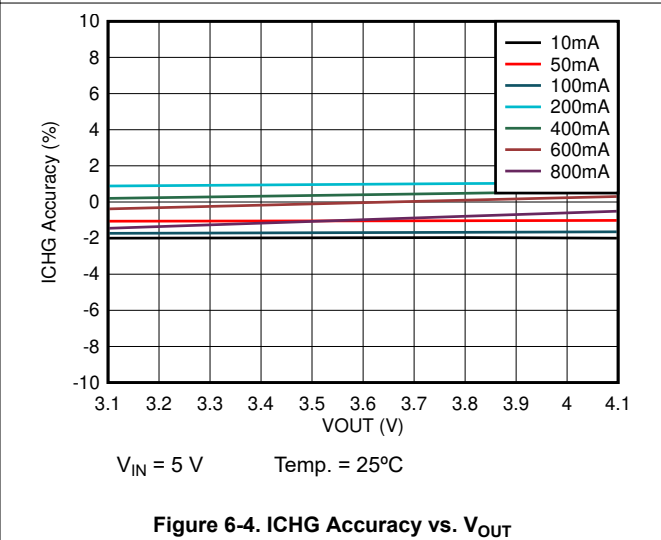
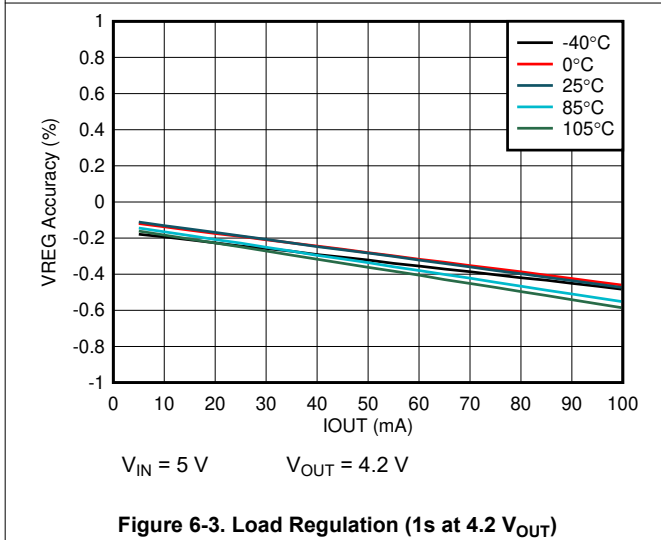
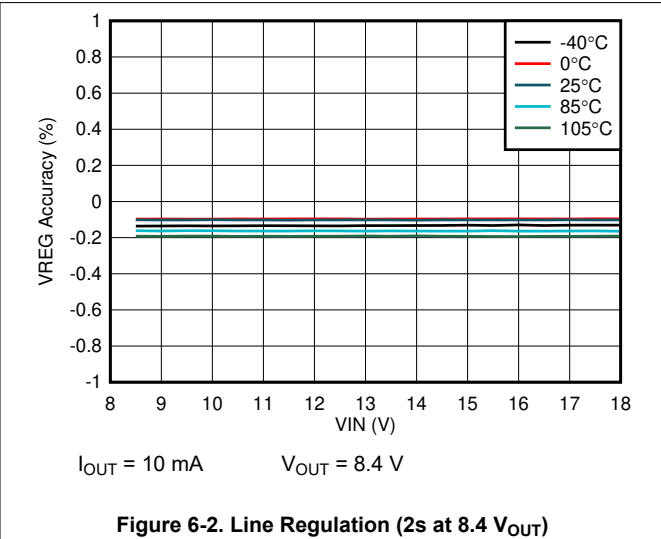
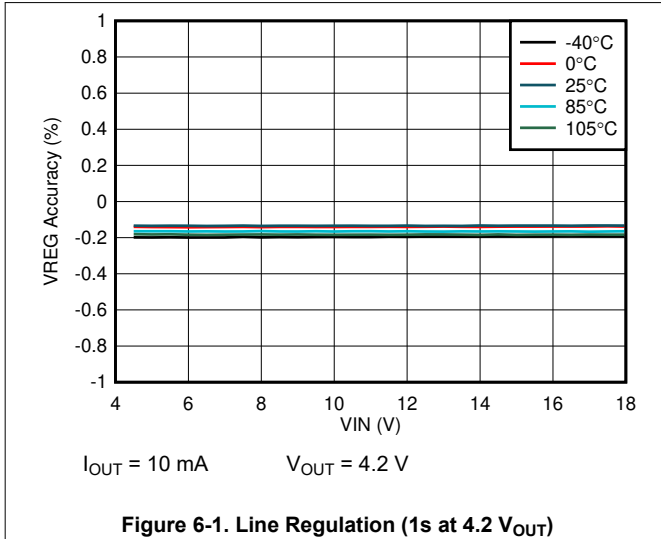
## 6.6 Timing Requirements

		MIN	NOM	MAX	UNIT
<b>BATTERY CHARGER</b>					
$t_{OUT\_OCP\_DGL}$	Deglitch time for $I_{OUT\_OCP}$ , $I_{OUT}$ rising		100		$\mu s$
$t_{PRECHG}$	Pre-charge safety timer accuracy	28.5	30	31.5	min
$t_{SAFETY}$	Fast-charge safety timer accuracy	9.5	10	10.5	hr
$t_{INTERMITTENT}$	Automotive Intermittent charge safety timer (NiMH), as percentage of $t_{SAFETY}$		25		%



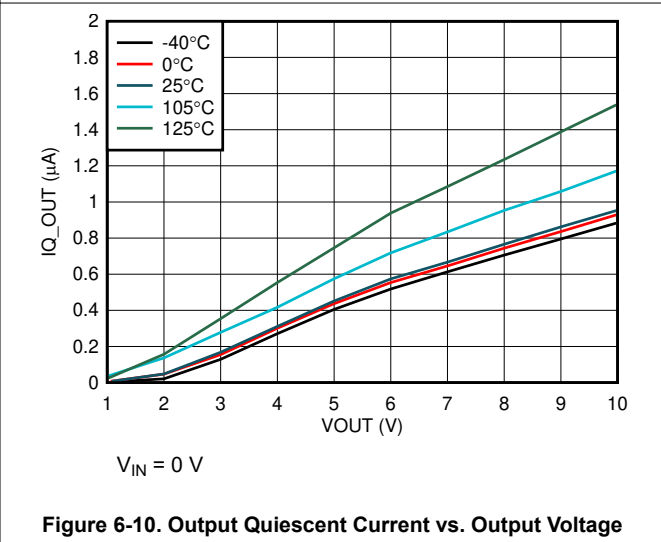
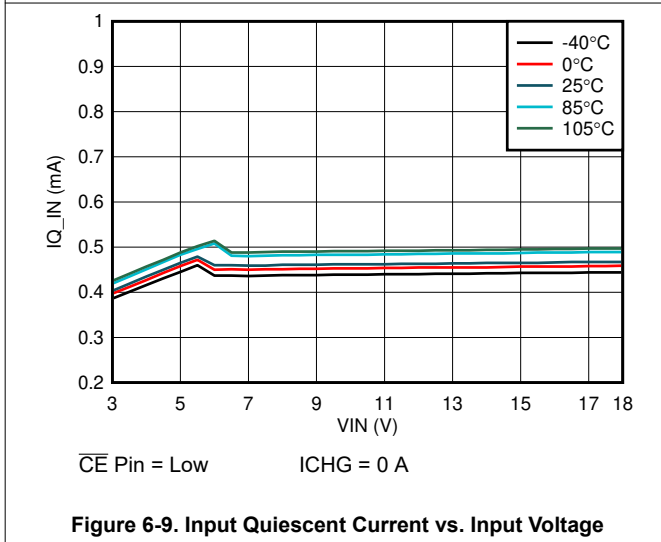
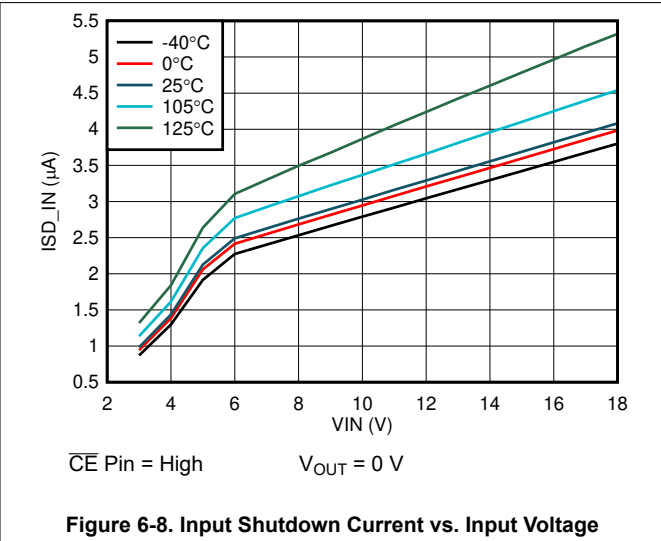
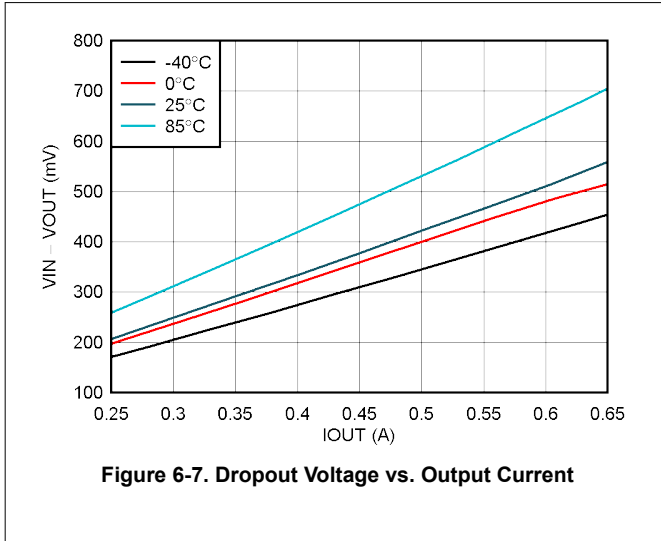
### 6.7 Typical Characteristics

$C_{IN} = 1 \mu F$ ,  $C_{OUT} = 1 \mu F$ ,  $V_{IN} = 5 V$ ,  $V_{OUT} = 3.8 V$  (unless otherwise specified)



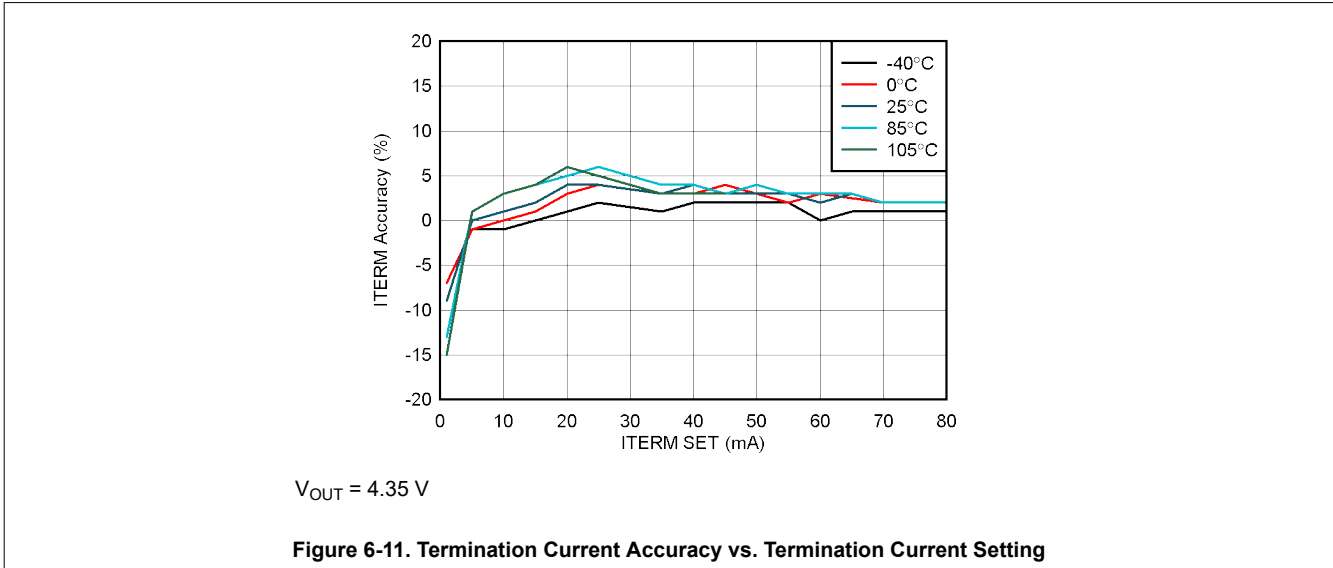
### 6.7 Typical Characteristics (continued)

$C_{IN} = 1 \mu F$ ,  $C_{OUT} = 1 \mu F$ ,  $V_{IN} = 5 V$ ,  $V_{OUT} = 3.8 V$  (unless otherwise specified)



### 6.7 Typical Characteristics (continued)

$C_{IN} = 1 \mu F$ ,  $C_{OUT} = 1 \mu F$ ,  $V_{IN} = 5 V$ ,  $V_{OUT} = 3.8 V$  (unless otherwise specified)



## 7 Detailed Description

### 7.1 Overview

The BQ25171-Q1 is an automotive rated, 800-mA linear charger for 1-cell and 2-cell Li-Ion, Li-Polymer, and  $\text{LiFePO}_4$ , in addition to 1-cell up to 6-cell NiMH battery applications. The device has a single power output that charges the battery. The system load can be placed in parallel with the battery, as long as the average system load does not prevent the battery from charging fully within the safety timer duration. When the system load is placed in parallel with the battery, the input current is shared between the system and the battery.

The device has three phases for charging a Li-Ion battery: precharge to recover a fully discharged battery, fast-charge constant current to supply the bulk of the charge, and voltage regulation to reach full capacity.

The device charges a NiMH in constant current mode only, and terminates the charge cycle when the programmable timer expires or the battery voltage exceeds the  $V_{\text{OUT\_OVP}}$  threshold. An optional intermittent charging phase can be programmed to automatically recharge a full NiMH battery once its voltage falls below  $V_{\text{RECHG}}$ .

The charger includes flexibility in programming of the fast-charge current and regulation voltage. This charger is designed to work with a variety of input supply ranges including direct car battery connection.

The charger also comes with a full set of safety features: battery temperature monitoring, overvoltage protection, charge safety timers, and configuration pin (VSET, ISET, CHM\_TMR) short and open protection. All of these features and more are described in detail below.

The charger is designed for a single path from the input to the output to charge the battery. Upon application of a valid input power source, the configuration pins are checked for short/open circuit.

If the Li-Ion battery voltage is below the  $V_{\text{BAT\_LOWV}}$  threshold, the battery is considered discharged and a preconditioning cycle begins. The amount of precharge current is 20% of the programmed fast-charge current via ISET pin. The  $t_{\text{PRECHG}}$  safety timer is active, and stops charging after expiration if battery voltage fails to rise above  $V_{\text{BAT\_LOWV}}$ .

Once the battery has charged to the  $V_{\text{BAT\_LOWV}}$  threshold, Fast Charge Mode is initiated, applying the fast charge current and starting the  $t_{\text{SAFETY}}$  timer. The fast charge constant current is programmed using the ISET pin. The constant current phase provides the bulk of the charge. Power dissipation in the IC is greatest in fast charge with a lower battery voltage. If the IC temperature reaches  $T_{\text{REG}}$ , the IC enters thermal regulation, slows the timer clock by half, and reduces the charge current as needed to keep the temperature from rising any further. [Figure 7-1](#) shows the typical Lithium battery charging profile with thermal regulation. Under normal operating conditions, the IC's junction temperature is less than  $T_{\text{REG}}$  and thermal regulation is not entered.

Once the battery has charged to the regulation voltage, the voltage loop takes control and holds the battery at the regulation voltage until the current tapers to the termination threshold. The termination threshold is 10% of the programmed fast-charge current.

Further details are described in [Section 7.3](#).

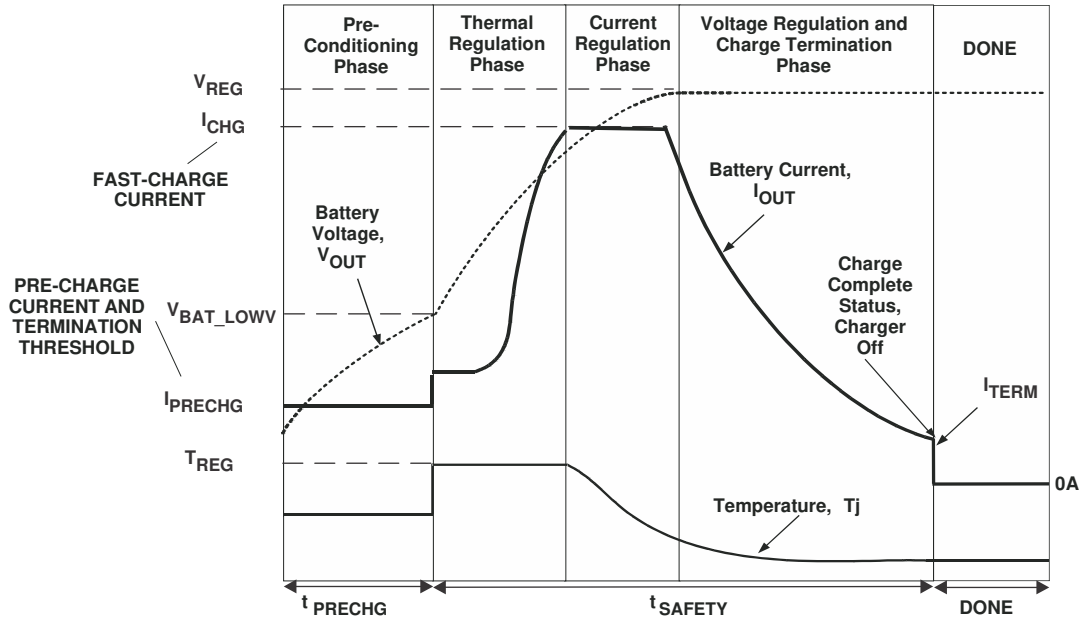
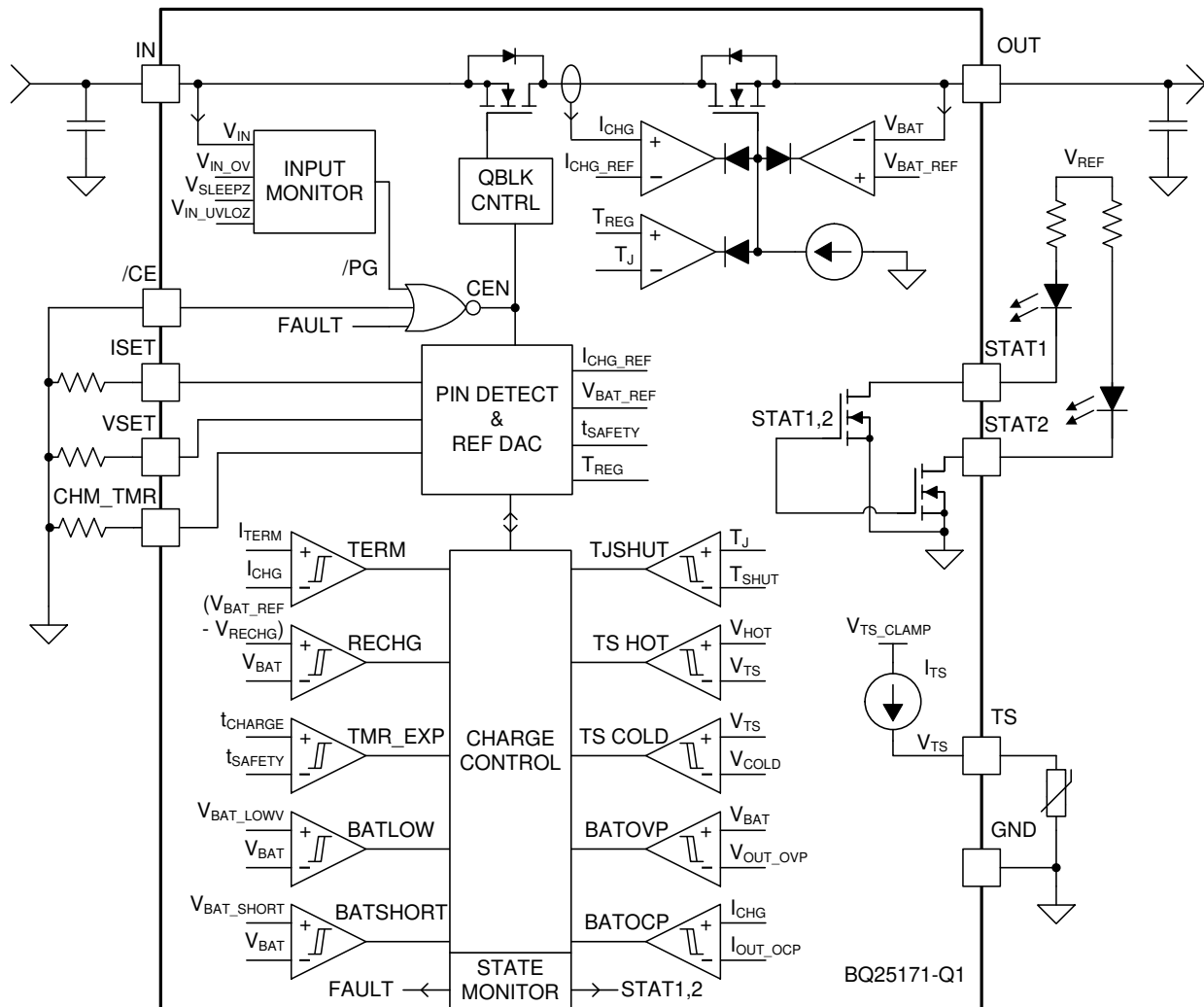


Figure 7-1. Lithium-Ion Battery Charging Profile with Thermal Regulation

## 7.2 Functional Block Diagram



## 7.3 Feature Description

### 7.3.1 Device Power Up from Input Source

When an input source is plugged in and charge is enabled, the device checks the input source voltage to turn on all the bias circuits. It detects and sets the input chemistry configuration, charge current and charge voltage limits before the linear regulator is started. The power up sequence from input source is as listed:

1. ISET pin detection
2. CHM\_TMR pin detection to select chemistry and charge timer
3. VSET pin detection to select charge voltage
4. Charger power up

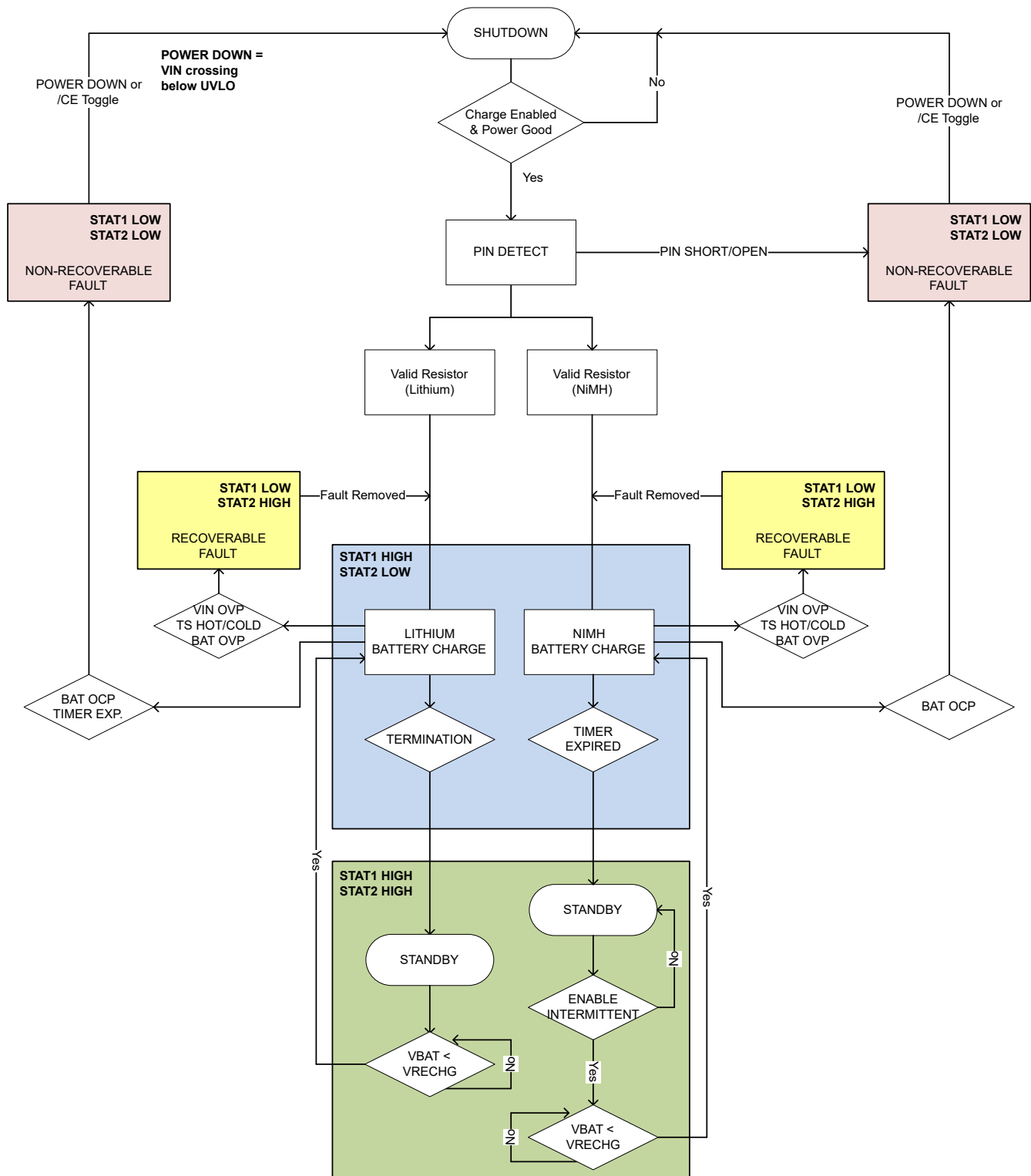


Figure 7-2. Simplified BQ25171-Q1 Flow Chart

### 7.3.1.1 ISET Pin Detection

After a valid VIN is plugged in and  $\overline{CE}$  pin is pulled LOW, the device checks the resistor on the ISET pin for a short circuit ( $R_{ISET} < R_{ISET\_SHORT}$ ). If a short condition is detected, the charger remains in the FAULT state until the input or  $\overline{CE}$  pin is toggled. If the ISET pin is open-circuit, the charger proceeds through pin detection and



starts the charger with no charge current. This pin is monitored while charging and changes in  $R_{ISET}$  while the charger is operating will immediately translate to changes in charge current.

An external pulldown resistor ( $\pm 1\%$  or better recommended to minimize charge current error) from ISET pin to GND sets the charge current as:

$$I_{CHG} = \frac{K_{ISET}}{R_{ISET}} \quad (1)$$

where

- $I_{CHG}$  is the desired fast-charge current
- $K_{ISET}$  is a gain factor found in the electrical specifications
- $R_{ISET}$  is the pulldown resistor from ISET pin to GND

For charge currents below 50 mA, an extra RC circuit is recommended on ISET to achieve more stable current signal. For greater accuracy at lower currents, part of the current-sensing FET is disabled to give better resolution.

### 7.3.1.2 CHM\_TMR Pin Detection

CHM\_TMR pin is used to program the device chemistry and safety timer using a  $\pm 1\%$  pulldown resistor. The available pulldown resistor and corresponding behaviors are:

**Table 7-1. CHM\_TMR Pin Resistor Value Table**

RESISTOR	CHEMISTRY	CHARGE TIMER (HR)
> 150 k $\Omega$	No charge (open-circuit)	No charge (open-circuit)
100 k $\Omega$	Li+	5 hr
82 k $\Omega$	Li+	10 hr
62 k $\Omega$	Li+	Timer disable
47 k $\Omega$	No charge (pin fault / margin)	No charge (pin fault / margin)
36 k $\Omega$	NiMH	4 hr
27 k $\Omega$	NiMH	6 hr
24 k $\Omega$	NiMH	8 hr
18 k $\Omega$	NiMH	10 hr
15 k $\Omega$	NiMH	12 hr
11 k $\Omega$	NiMH	14 hr
8.2 k $\Omega$	NiMH	16 hr
6.2 k $\Omega$	NiMH	18 hr
4.7 k $\Omega$	NiMH	20 hr
3.6 k $\Omega$	NiMH	22 hr
< 3.0 k $\Omega$	No charge (short-circuit)	No charge (short-circuit)

If either a short- or open-circuit condition is detected, charger stops operation and remains in the FAULT state until the input or  $\overline{CE}$  pin is toggled.

Once a value has been detected, it is latched in and the pin is not continuously monitored during operation. A change in this pin will not be acknowledged by the IC until the input supply or  $\overline{CE}$  pin is toggled.

### 7.3.1.3 VSET Pin Detection

VSET pin is used to program the device regulation voltage at end-of-charge using a  $\pm 1\%$  pulldown resistor. The available pulldown resistor and corresponding charging levels are:

**Table 7-2. VSET Pin Resistor Value Table**

RESISTOR	Li+ CONFIGURATION	NiMH CONFIGURATION
	CHARGE VOLTAGE (V)	CELL COUNT
> 150 kΩ	No charge (open-circuit)	No charge (open-circuit)
100 kΩ	1-cell LiFePO <sub>4</sub> : 3.50 V	No charge (open-circuit)
82 kΩ	1-cell LiFePO <sub>4</sub> : 3.60 V	No charge (open-circuit)
62 kΩ	1-cell LiFePO <sub>4</sub> : 3.70 V	1-cell
47 kΩ	1-cell Lilon: 3.80 V	1-cell + intermittent charge
36 kΩ	1-cell Lilon: 3.90 V	2-cell
27 kΩ	1-cell Lilon: 4.05 V	2-cell + intermittent charge
24 kΩ	1-cell Lilon: 4.10 V	3-cell
18 kΩ	1-cell Lilon: 4.20 V	3-cell + intermittent charge
15 kΩ	1-cell Lilon: 4.35 V	4-cell
11 kΩ	2-cell LiFePO <sub>4</sub> : 7.00 V	4-cell + intermittent charge
8.2 kΩ	2-cell LiFePO <sub>4</sub> : 7.20 V	5-cell
6.2 kΩ	2-cell LiFePO <sub>4</sub> : 7.40 V	5-cell + intermittent charge
4.7 kΩ	2-cell Lilon: 8.20 V	6-cell
3.6 kΩ	2-cell Lilon: 8.40 V	6-cell + intermittent charge
< 3.0 kΩ	No charge (short-circuit)	No charge (short-circuit)

If either a short- or open-circuit condition is detected, charger stops operation and remains in the FAULT state until the input or  $\overline{CE}$  pin is toggled.

Once a valid resistor value has been detected, the corresponding charge voltage is latched in and the pin is not continuously monitored during operation. A change in this pin will not be acknowledged by the IC until the input supply or  $\overline{CE}$  pin is toggled.

### 7.3.1.4 Charger Power Up

After VSET, ISET and CHM\_TMR pin resistor values have been validated, the device proceeds to enable the charger. The device automatically begins operation at the correct stage of battery charging depending on the OUT voltage.

### 7.3.2 Battery Charging Features

When charge is enabled, the device automatically completes a charging cycle according to the settings on VSET, ISET and CHM\_TMR pins without any intervention. The lithium-based charging cycle is automatically terminated when the charging current is below termination threshold, charge voltage is above recharge threshold, and device is not in thermal regulation (TREG). When a full battery is discharged below the recharge threshold ( $V_{RECHG}$ ), the device automatically starts a new charging cycle. After charge is done, toggling the input supply or the  $\overline{CE}$  pin can initiate a new charging cycle.

#### 7.3.2.1 Lithium-Ion Battery Charging Profile

The device charges a lithium based battery in four phases: trickle charge, precharge, constant current and constant voltage. At the beginning of a charging cycle, the device checks the battery voltage and regulates current and voltage accordingly.

If the charger is in thermal regulation during charging, the actual charging current will be less than the programmed value. In this case, termination is temporarily disabled and the charging safety timer is counted at half the clock rate. For more information, refer to [Section 7.3.2.3](#).

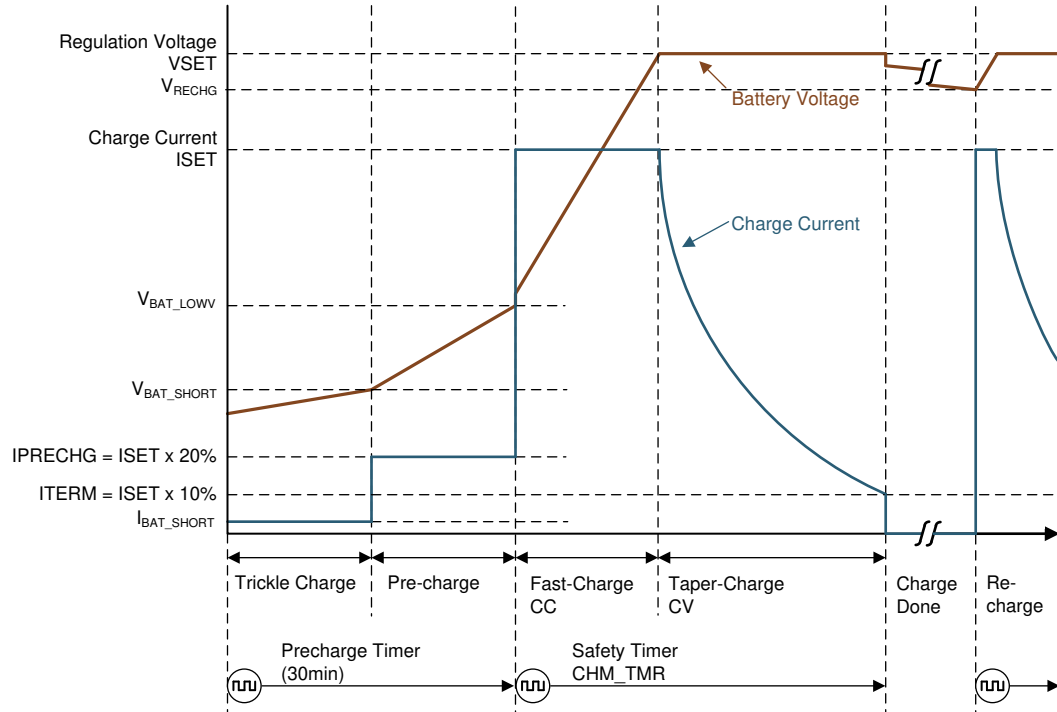


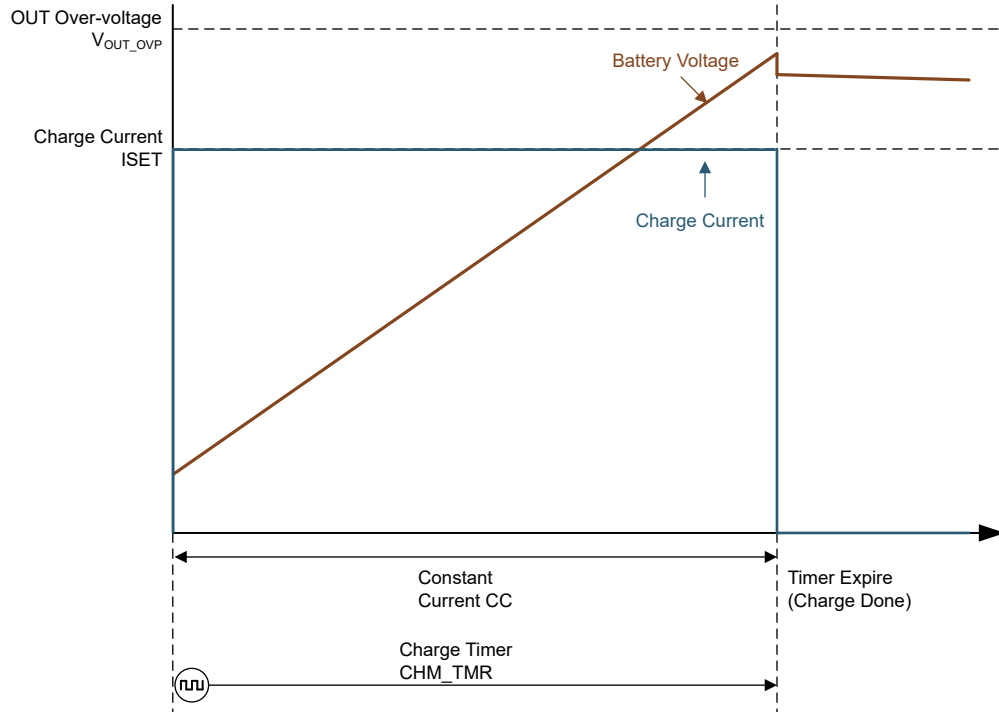
Figure 7-3. Lithium-Based Battery Charging Profile

#### 7.3.2.1.1 NiMH Battery Charging Profile

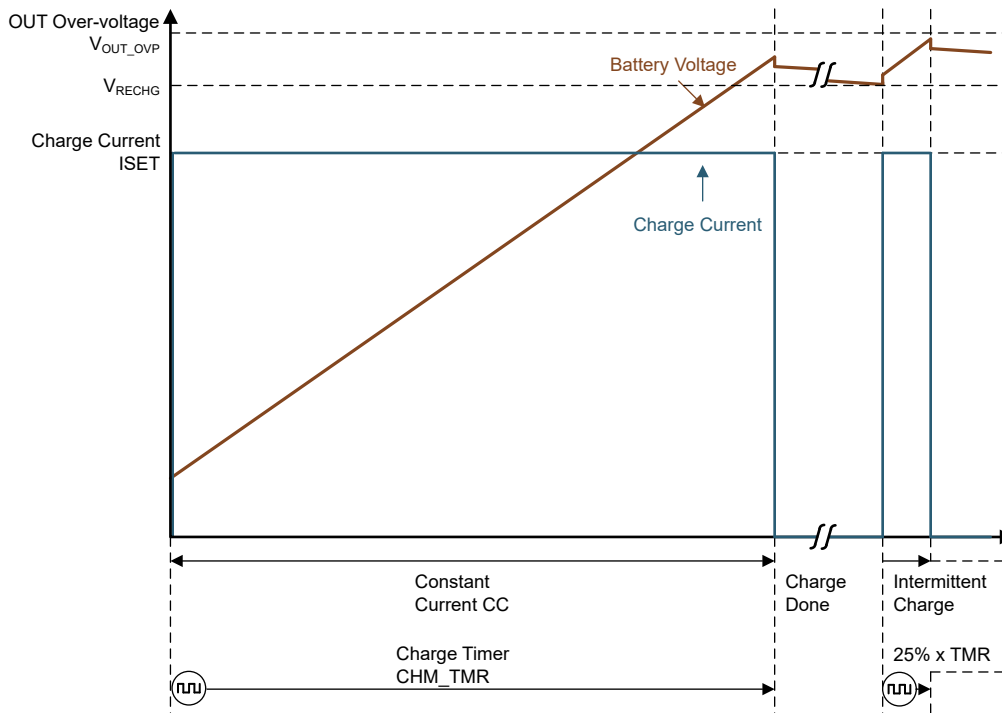
The device charges a NiMH battery in two phases: constant current and intermittent charge (optional). The duration for constant current charging is controlled by the charge timer, which is programmed using the CHM\_TMR pin. Intermittent charging is designed to replenish the natural self-discharge of NiMH by restarting a short charge cycle (25% of programmed charge timer) when the output voltage falls below VRECHG threshold. If the intermittent charging function is disabled, the device will charge a battery once, and not start a recharge cycle automatically. In this case, a new charge cycle can be initiated by toggling the input supply or the  $\overline{CE}$  pin.

Before initiating a NiMH charge cycle, the device checks for a full battery. If battery voltage is above VRECHG, the battery is considered full and the device does not charge. Once the battery voltage falls below VRECHG, the device automatically begins charging. If the intermittent charging function is disabled, a single charge cycle is initiated with the charge timer as programmed by CHM\_TMR pin. If intermittent charging is enabled, an intermittent charge cycle is initiated with charge timer as 25% of CHM\_TMR programmed value.

If the charger is in thermal regulation during charging, the actual charging current will be less than the programmed value. For NiMH charging, termination by timer is still enabled, but the charging safety timer is counted at half the clock rate. For more information, refer to [Section 7.3.2.3](#).



**Figure 7-4. NiMH Battery Charging Profile with Intermittent Charging Disabled**



**Figure 7-5. NiMH Battery Charging Profile with Intermittent Charging Enabled**

### 7.3.2.2 Charge Termination and Battery Recharge

When configured as a lithium battery charger, the device terminates a charge cycle when the OUT pin voltage is above the recharge threshold ( $V_{RECHG}$ ), and the current is below the termination threshold ( $I_{TERM}$ ). Termination is temporarily disabled when the charger device is in thermal regulation. After charge termination is detected,

the linear regulator turns off and the device enters STANDBY state. Once the OUT pin drops below the  $V_{RECHG}$  threshold, a new charge cycle is automatically initiated.

When configured as NiMH battery charger, the device terminates a charge cycle when the charge safety timer expires. If intermittent charging is enabled, a new charge cycle with 25% of original programmed timer duration will start once the battery voltage falls below  $V_{RECHG}$ . For example, after a 20 hour charge cycle finishes, and then the battery falls below  $V_{RECHG}$ , the device recharges the battery for 5 hours: ( $t_{INTERMITTENT} = 25\% \times t_{SAFETY}$ ). If intermittent charging is disabled, the device will not start a new charge cycle automatically based on the  $V_{RECHG}$  threshold. A toggle on the input supply or the  $\overline{CE}$  pin is required to restart a charge cycle in this case.

### 7.3.2.3 Charging Safety Timers

The device has built-in safety timers to prevent an extended charging cycle due to abnormal battery conditions. The precharge timer is fixed at 30 minutes. The user can program or disable the fast charge safety timer through the CHM\_TMR pin. When safety timer expires, the charge cycle ends. A toggle on the input supply or  $\overline{CE}$  pin is required to restart a charge cycle after the safety timer has expired.

During thermal regulation, the safety timer counts at half clock rate as the actual charge current is likely to be below the ISET setting. For example, if the charger is in thermal regulation throughout the whole charging cycle, and the safety timer is 10 hours, then the timer will expire in 20 hours.

During faults which disable charging, such as VIN OVP, BAT OVP, TSHUT or TS faults, the timer is suspended. Once the fault goes away, charging and the safety timer resumes. If the charging cycle is stopped and started again, the timer gets reset (toggle  $\overline{CE}$  pin restarts the timer).

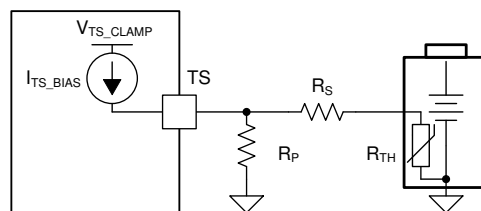
The safety timer restarts counting for the following events:

1. Charging cycle stop and restart (toggle  $\overline{CE}$  pin, charged battery falls below recharge threshold, or toggle input supply)
2. OUT pin voltage crosses the  $V_{BAT\_LOWV}$  threshold in either direction

The precharge safety timer (fixed counter that runs when  $V_{OUT} < V_{BAT\_LOWV}$ ), follows the same rules as the fast-charge safety timer in terms of getting suspended, reset, and counting at half-rate.

### 7.3.2.4 Battery Cold, Hot Temperature Qualification (TS Pin)

While charging, the device continuously monitors battery temperature by sensing the voltage at the TS pin. A negative temperature coefficient (NTC) thermistor should be connected between the TS and GND pins (recommend: 103AT-2). If temperature sensing is not required in the application, connect a fixed 10-k $\Omega$  resistor from TS to GND to allow normal operation. Battery charging is allowed when the TS pin voltage falls between  $V_{COLD}$  and  $V_{HOT}$  thresholds (typically 0°C – 45°C). The temperature corresponding to these voltage thresholds can be modified by adding resistors in parallel and in series with the thermistor, as shown in Figure 7-6. If the TS pin indicates battery temperature is outside this range, the device stops charging, enters the STANDBY state, and sets the STAT pins to STAT1 = LOW, STAT2 = HIGH to indicate a recoverable fault. Once battery temperature returns to normal conditions, charging resumes automatically.



**Figure 7-6. TS Resistor Network For Modified Temperature Charging Window**

**Table 7-3. Recommended Resistor Values for Different Temperature Charging Windows**

TEMPERATURE CHARGING WINDOW	$R_S$	$R_P$
0°C to 60°C	1.9 k $\Omega$	400 k $\Omega$
-10°C to 60°C	2.3 k $\Omega$	70 k $\Omega$
-10°C to 50°C	1.1 k $\Omega$	70 k $\Omega$

### 7.3.3 Status Outputs (STAT1, STAT2)

#### 7.3.3.1 Charging Status Indicator (STAT1, STAT2)

The device indicates the charging state on the open-drain STAT1, STAT2 pin. This pin can drive an LED.

**Table 7-4. STAT1 and STAT2 Pin States**

CHARGING STATE	STAT1 PIN STATE	STAT2 PIN STATE
Charge completed, charger in sleep mode or charge disabled (including $V_{OUT} > V_{RECHG}$ after TMR_EXP for NiMH charging)	HIGH	HIGH
Normal charge in progress (including intermittent charge active for NiMH, and automatic recharge for Li+ charger)	HIGH	LOW
Recoverable fault (VIN OVP, BAT OVP, TS HOT, TS COLD, TSHUT)	LOW	HIGH
Non-recoverable or latch-off fault (VSET/CHM_TMR/ISET pin short/open, BAT OCP, TMR_EXP for Li+ charging, $V_{OUT} < V_{RECHG}$ after TMR_EXP for NiMH charging)	LOW	LOW

Safety timer expiration event (TMR\_EXP) is addressed differently depending on whether the charger is configured as a NiMH or Li+ charger. For Lithium-based charging, TMR\_EXP is reported as a non-recoverable fault by setting STAT1 = LOW and STAT2 = LOW. For NiMH-based charging, TMR\_EXP with  $V_{OUT} > V_{RECHG}$  is the expected termination method, and shall be reported as charge complete with STAT1 = HIGH and STAT2 = HIGH. For NiMH-based charging, TMR\_EXP with  $V_{OUT} < V_{RECHG}$  is a non-recoverable fault and shall be reported by setting STAT1 = LOW and STAT2 = LOW. An input supply or  $\overline{CE}$  pin toggle is required to attempt charging after a non-recoverable fault is detected.

### 7.3.4 Protection Features

The device closely monitors input and output voltage, as well as internal FET current and temperature for safe linear regulator operation.

#### 7.3.4.1 Input Overvoltage Protection (VIN OVP)

If the voltage at IN pin exceeds  $V_{IN\_OV}$ , the device turns off after a deglitch,  $t_{VIN\_OV\_DGL}$ . The safety timer suspends count and device enters STANDBY mode. Once the IN voltage recovers to normal level, the charge cycle and the safety timer automatically resume operation.

#### 7.3.4.2 Output Overvoltage Protection (BAT OVP)

If the voltage at OUT pin exceeds  $V_{OUT\_OVP}$ , the device immediately stops charging. The safety timer suspends count and device enters STANDBY mode. Once the OUT voltage recovers to normal level, the charge cycle and the safety timer resume operation.

#### 7.3.4.3 Output Overcurrent Protection (BAT OCP)

During normal operation, the OUT current should be regulated to ISET programmed value. However, if a short circuit occurs on ISET pin, the OUT current may rise to unintended level. If the current at OUT pin exceeds  $I_{OUT\_OCP}$ , the device turns off after a deglitch,  $t_{OUT\_OCP\_DGL}$ . The safety timer resets the count, and device remains latched off. An input supply or  $\overline{CE}$  pin toggle is required to restart operation.

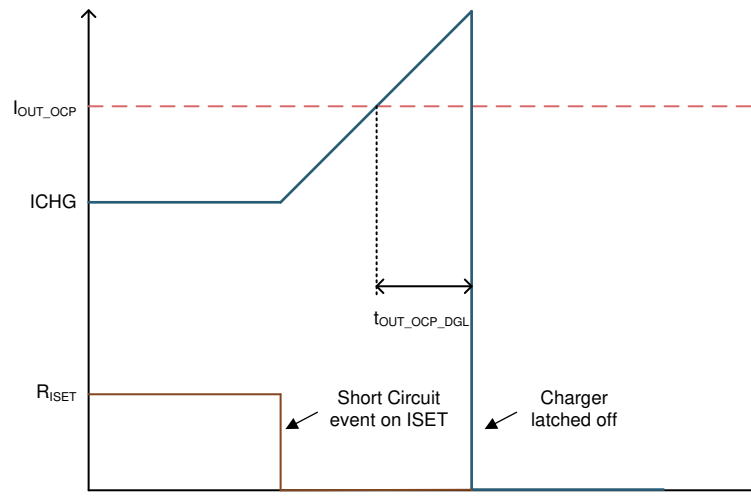


Figure 7-7. Overcurrent Protection

#### 7.3.4.4 Thermal Regulation and Thermal Shutdown (TREG and TSHUT)

The device monitors its internal junction temperature ( $T_J$ ) to avoid overheating and to limit the IC surface temperature. When the internal junction temperature exceeds the thermal regulation limit, the device automatically reduces the charge current to maintain the junction temperature at the thermal regulation limit (TREG). During thermal regulation, the actual charging current is usually below the programmed value on the ISET pin. Therefore, the termination comparator for the Lithium-Ion battery is disabled, and the safety timer runs at half the clock rate.

Additionally, the device has thermal shutdown to turn off the linear regulator when the IC junction temperature exceeds the TSHUT threshold. A recoverable fault is signaled via the status pins (STAT1 = LOW, STAT2 = HIGH). The charger resumes operation when the IC die temperature decreases below the TSHUT falling threshold.

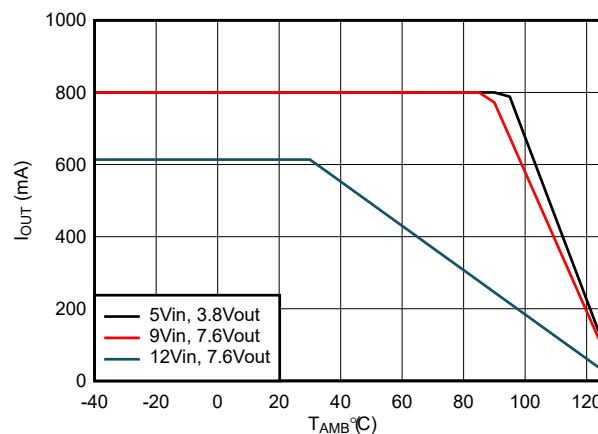


Figure 7-8. Typical Charge Current Capability vs Ambient Temperature

## 7.4 Device Functional Modes

### 7.4.1 Shutdown or Undervoltage Lockout (UVLO)

The device is in shutdown state if the IN pin voltage is less than  $V_{IN\_LOWV}$ , or the  $\overline{CE}$  pin is HIGH. The internal circuitry is powered down, all the pins are high impedance, and the device draws  $I_{SD\_IN}$  from the input supply.

Once the IN voltage rises above the  $V_{IN\_LOW}$  threshold and the  $\overline{CE}$  pin is LOW, the IC will enter Sleep Mode or Active Mode depending on the OUT pin voltage.

#### 7.4.2 Sleep Mode

The device is in Sleep Mode when  $V_{IN\_LOWV} < V_{IN} < V_{OUT} + V_{SLEEPZ}$ . The device waits for the input voltage to rise above  $V_{OUT} + V_{SLEEPZ}$  to start operation.

#### 7.4.3 Active Mode

The device is powered up and charges the battery when the  $\overline{CE}$  pin is LOW and the IN voltage ramps above both  $V_{IN\_LOWV}$ , and  $V_{OUT} + V_{SLEEPZ}$ . The device draws  $I_{Q\_IN}$  from the supply to bias the internal circuitry. For details on device power-up sequence, refer to [Section 7.3.1](#).

##### 7.4.3.1 Standby Mode

The device is in Standby Mode if a valid input supply is present and charge is terminated or if a recoverable fault is detected. The internal circuitry is partially biased, and the device continues to monitor for either VOUT to drop below  $V_{RECHG}$ , or the recoverable fault to be removed.

#### 7.4.4 Fault Mode

The fault conditions are categorized into recoverable and nonrecoverable as follows:

- Recoverable(STAT1 = LOW, STAT2 = HIGH), from which the device should automatically recover once the fault condition is removed:
  - VIN OVP
  - BAT OVP
  - TS HOT
  - TS COLD
- Nonrecoverable(STAT1 = LOW, STAT2 = HIGH), requiring  $\overline{CE}$  pin or input supply toggle to resume operation:
  - BAT OCP
  - ISET pin short detected
  - VSET pin short/open detected
  - CHM\_TMR pin short/open detected



## 8 Application and Implementation

### Note

Information in the following applications sections is not part of the TI component specification, and TI does not warrant its accuracy or completeness. TI's customers are responsible for determining suitability of components for their purposes, as well as validating and testing their design implementation to confirm system functionality.

### 8.1 Application Information

A typical application consists of the device configured as a standalone battery charger for Lithium-Ion, Li-Polymer, LiFePO<sub>4</sub>, or NiMH batteries. The battery charge profile and the safety charge timer are configured using a pull-down resistor on the CHM\_TMR pin. The charge voltage and the number of cells are configured using a pull-down resistor on the VSET pin. Charge current is configured using a pull-down resistor on the ISET pin. A battery thermistor may be connected to the TS pin to allow the device to monitor battery temperature and control charging. Pulling the CE pin high disables the charging function. Charger status is reported via the STAT1 and STAT2 status pins.

### 8.2 Typical Applications

#### 8.2.1 1s LiFePO<sub>4</sub> Charger Design Example

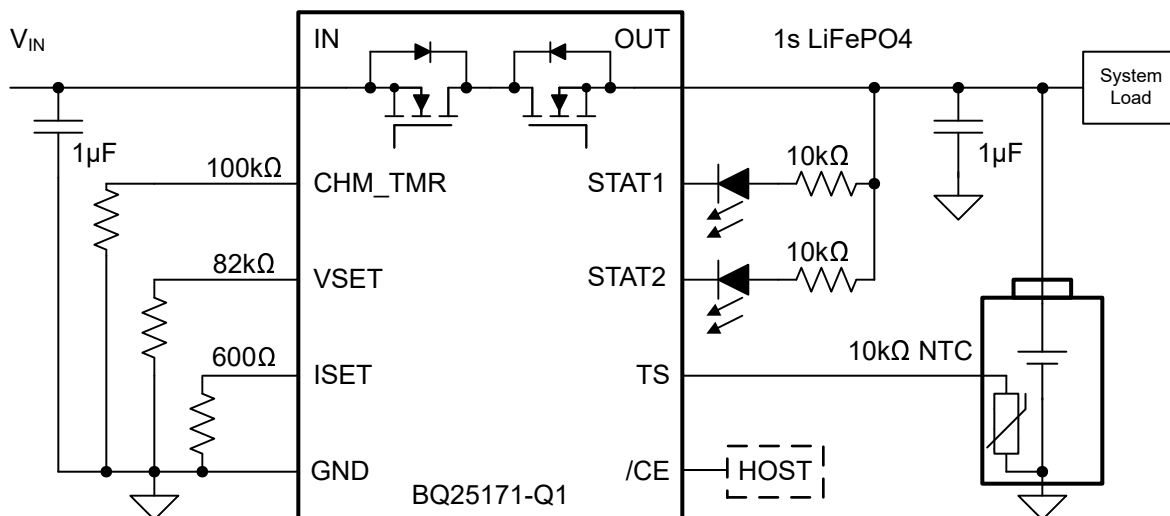


Figure 8-1. BQ25171-Q1 Typical Application for 1s LiFePO<sub>4</sub> Charging at 500 mA

#### 8.2.1.1 Design Requirements

- Supply voltage = 5 V
- Battery is single-cell LiFePO<sub>4</sub>
- Fast charge current:  $I_{CHG} = 500$  mA
- Charge voltage:  $V_{REG} = 3.6$  V
- Charge safety timer:  $t_{SAFETY} = 5$  hr
- Termination current:  $I_{TERM} = 10\%$  of  $I_{CHG}$  or 50 mA
- Precharge current:  $I_{PRECHG} = 20\%$  of  $I_{CHG}$  or 100 mA
- TS – Battery temperature sense = 10-kΩ NTC (103AT)
- CE is an open drain control pin

#### 8.2.1.2 Detailed Design Procedure

- The regulation voltage is set via the VSET pin to 3.6 V, the input voltage is 5 V, and the charge current is programmed via the ISET pin to 500 mA.

- The charging chemistry and safety timer are set to LiFePO<sub>4</sub> and 5 hr, respectively, via the CHM\_TMR pin.

#### 8.2.1.2.1 Program the Fast Charge Current, ISET:

$$R_{ISET} = [K_{ISET} / I_{CHG}]$$

from electrical characteristics table. . .  $K_{ISET} = 300 \text{ A}\Omega$

$$R_{ISET} = [300 \text{ A}\Omega / 0.5 \text{ A}] = 600 \Omega$$

Selecting the closest 1% resistor standard value, use a 604- $\Omega$  resistor between ISET and GND, for an expected  $I_{CHG}$  of 497 mA.

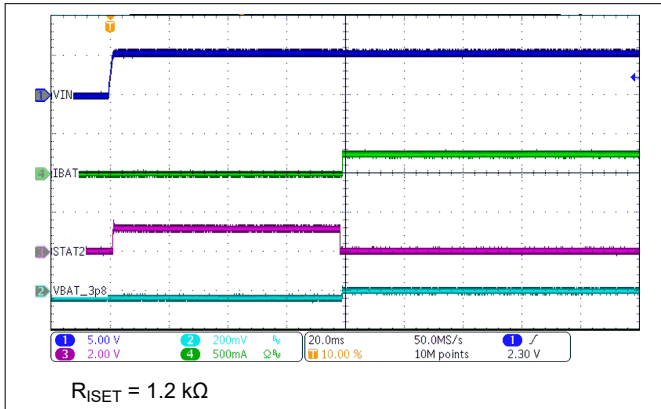
#### 8.2.1.2.2 TS Function

Use a 10-k $\Omega$  NTC thermistor in the battery pack (recommend: 103AT-2). The  $V_{COLD}$  and  $V_{HOT}$  thresholds in the data sheet are designed to meet a charging window between 0°C and 45°C for a 10-k $\Omega$  NTC with  $\beta = 3435 \text{ K}$ .

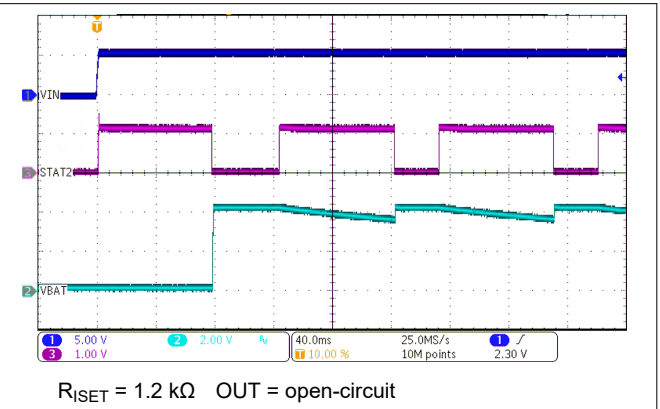
To disable the TS sense function, use a fixed 10-k $\Omega$  resistor between the TS and GND pins.

### 8.2.1.3 Application Curves

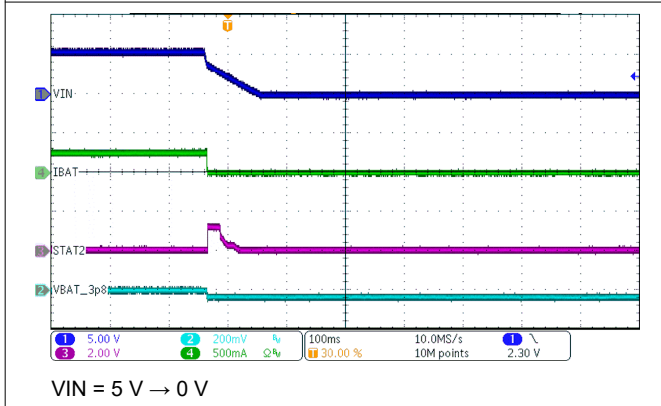
$C_{IN} = 1 \mu\text{F}$ ,  $C_{OUT} = 1 \mu\text{F}$ ,  $V_{IN} = 5 \text{ V}$ ,  $V_{OUT} = 3.8 \text{ V}$ ,  $I_{CHG} = 250 \text{ mA}$  (unless otherwise specified)



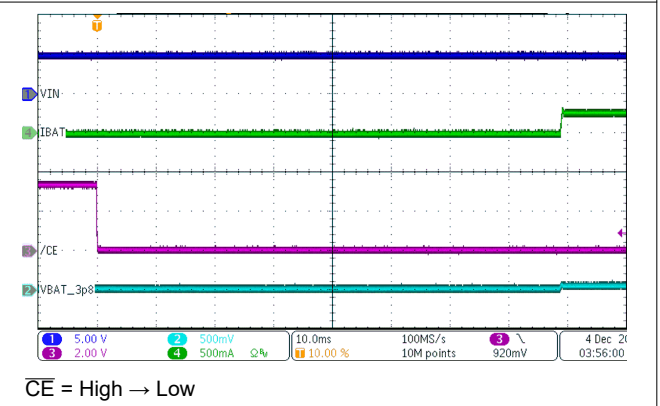
**Figure 8-2. Power Up with Battery (1-cell Li-Ion)**



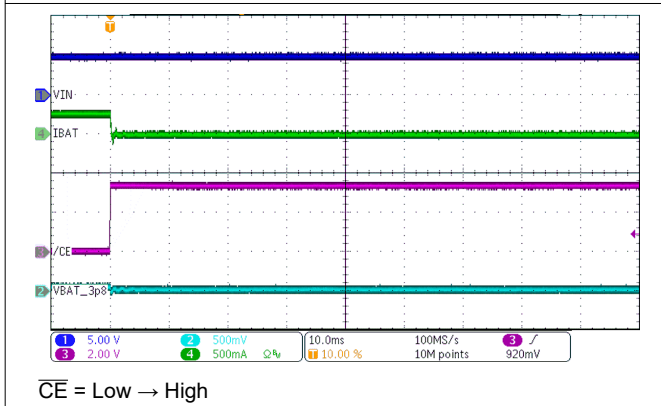
**Figure 8-3. Power Up without Battery**



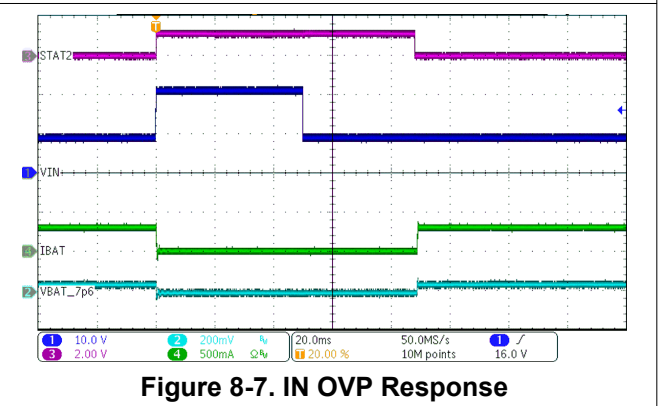
**Figure 8-4. Power Down**



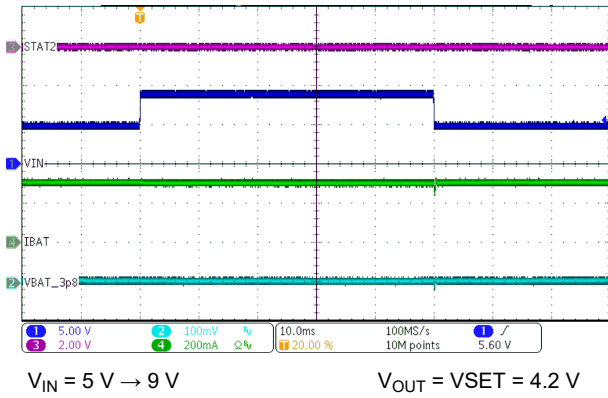
**Figure 8-5. Charge Enable**



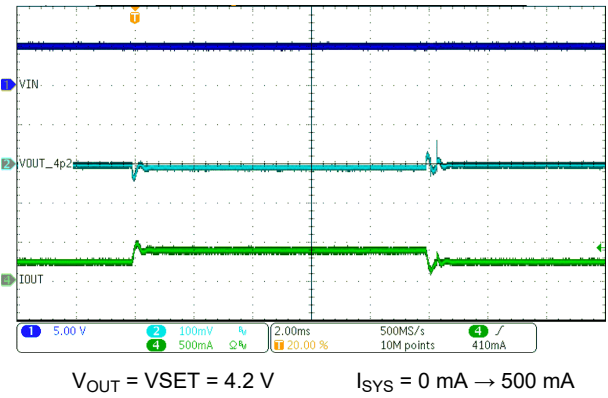
**Figure 8-6. Charge Disable**



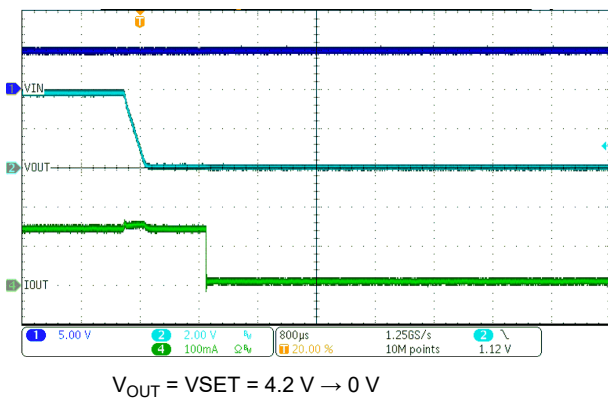
**Figure 8-7. IN OVP Response**



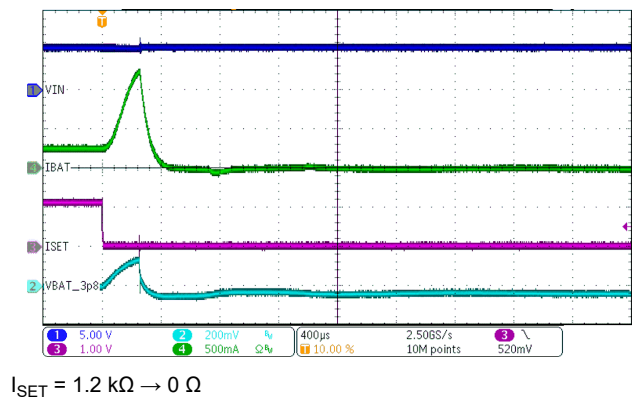
**Figure 8-8. IN Transient Response**



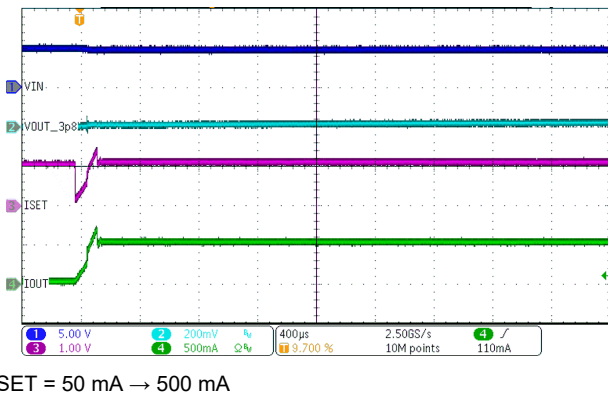
**Figure 8-9. OUT Transient Response**



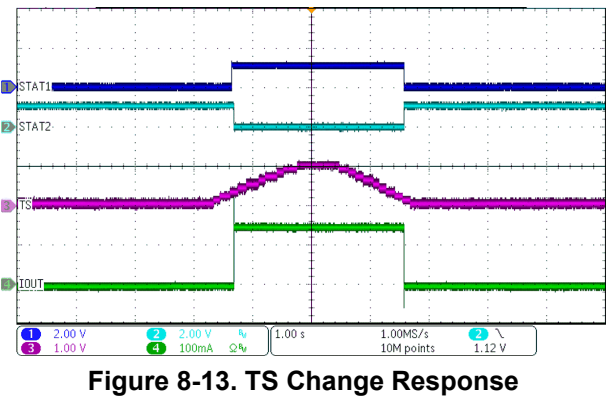
**Figure 8-10. OUT Short-Circuit Response**



**Figure 8-11. ISET Short-Circuit Response**

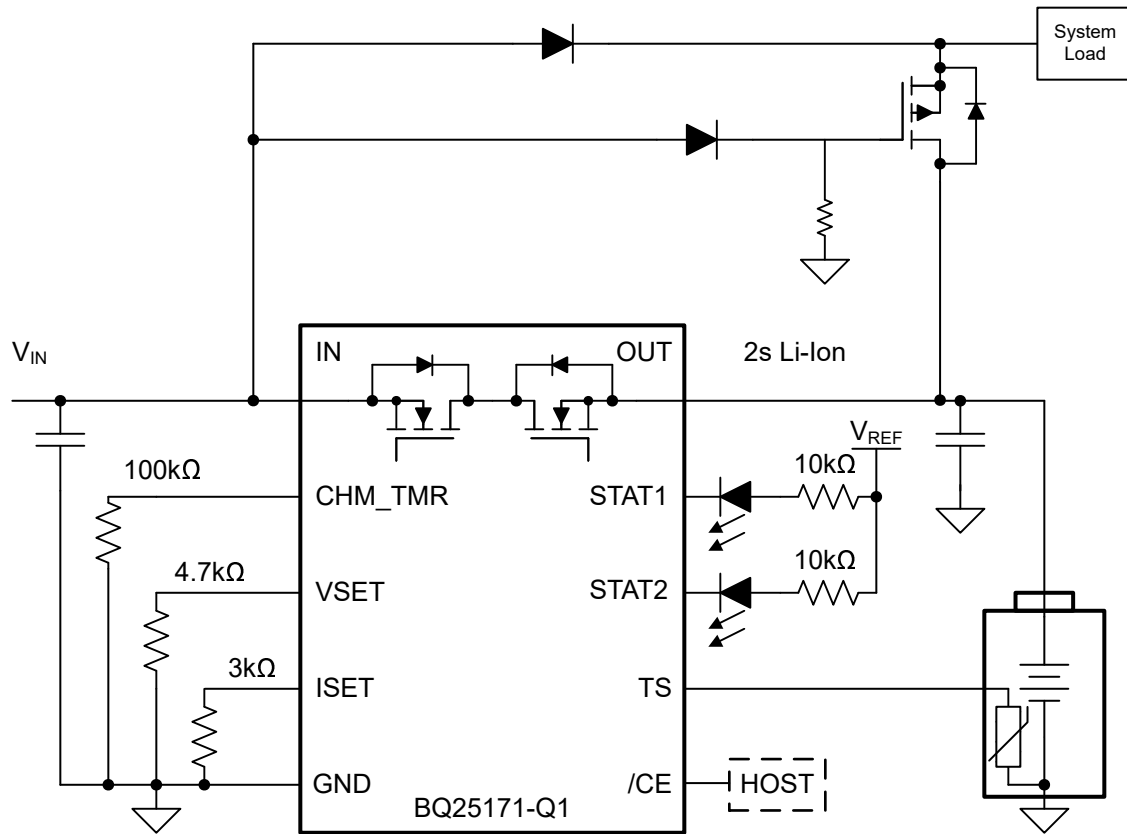


**Figure 8-12. ISET Change Response**



**Figure 8-13. TS Change Response**

### 8.2.2 2s Li-Ion Charger with Power Path Design Example



**Figure 8-14. BQ25171-Q1 Typical Application for 2s Lilon Charging at 100 mA**

#### 8.2.2.1 Design Requirements

The design requirements include the following:

- Input supply up to 18 V
- Battery is 2-cell Li-Ion
- Fast charge current:  $I_{CHG} = 100 \text{ mA}$
- Charge voltage:  $V_{REG} = 8.2 \text{ V}$
- Charge safety timer:  $t_{SAFETY} = 5 \text{ hr}$
- Termination current:  $I_{TERM} = 10\% \text{ of } I_{CHG} \text{ or } 10 \text{ mA}$
- Precharge current:  $I_{PRECHG} = 20\% \text{ of } I_{CHG} \text{ or } 20 \text{ mA}$
- TS – Battery temperature sense = 10-kΩ NTC (103AT)
  - Charging allowed between battery temperatures of 0°C to 45°C
- $\overline{CE}$  is a control pin, pull high to disable the charger

### 8.2.3 4s NiMH Charger Design Example

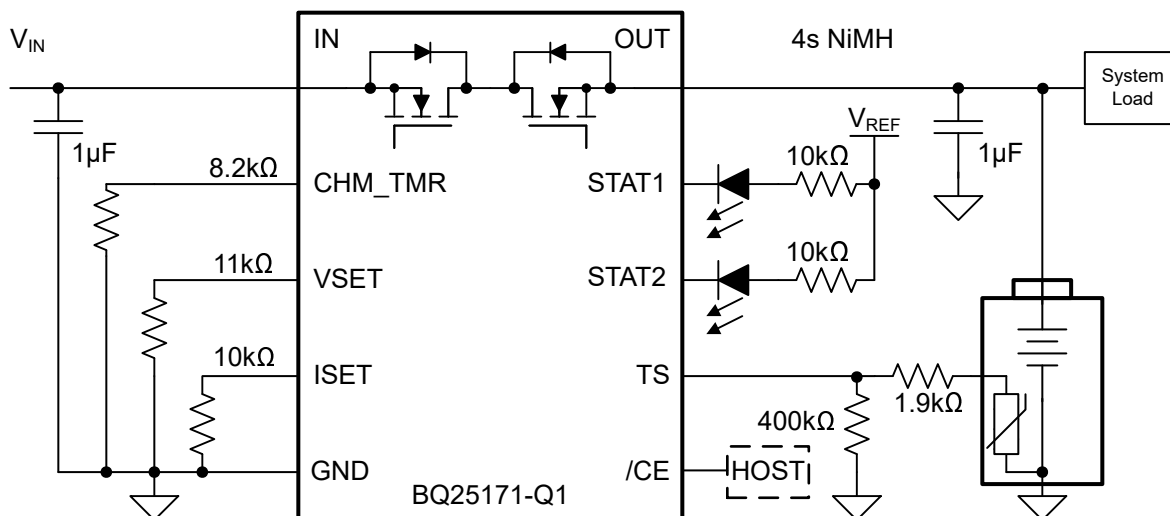


Figure 8-15. BQ25171-Q1 Typical Application for 4s NiMH with Intermittent Charging Enabled

#### 8.2.3.1 Design Requirements

The design requirements include the following:

- Input supply up to 18 V
- Battery is 4-cell NiMH
- Fast charge current:  $I_{CHG} = 30 \text{ mA}$
- Recharge voltage for intermittent cycles:  $V_{RECHG} = 1.33\text{V} \times 4 = 5.32 \text{ V}$
- Charge safety timer:  $t_{SAFETY}$ : 16 hr
- TS – Battery temperature sense = 10-kΩ NTC (103AT-2)
  - $R_S = 1.9 \text{ k}\Omega$  and  $R_P = 400 \text{ k}\Omega$  added to modify battery charging temperature window to:  $0^\circ\text{C}$  to  $60^\circ\text{C}$
- $\overline{CE}$  is a control pin, pull high to disable the charger

## 9 Power Supply Recommendations

The device is designed to operate from an input voltage supply range between 3.0 V and 18 V (up to 40 V tolerant) and current capability of at least the maximum designed charge current. If located more than a few inches from the IN and GND pins, a larger capacitor is recommended.

## 10 Layout

### 10.1 Layout Guidelines

To obtain optimal performance, the decoupling capacitor from IN to GND and the output filter capacitor from OUT to GND should be placed as close as possible to the device, with short trace runs to both IN, OUT and GND.

- All low-current GND connections should be kept separate from the high-current charge or discharge paths from the battery. Use a single-point ground technique incorporating both the small signal ground path and the power ground path.
- The high current charge paths into IN pin and from the OUT pin must be sized appropriately for the maximum charge current in order to avoid voltage drops in these traces.

### 10.2 Layout Example

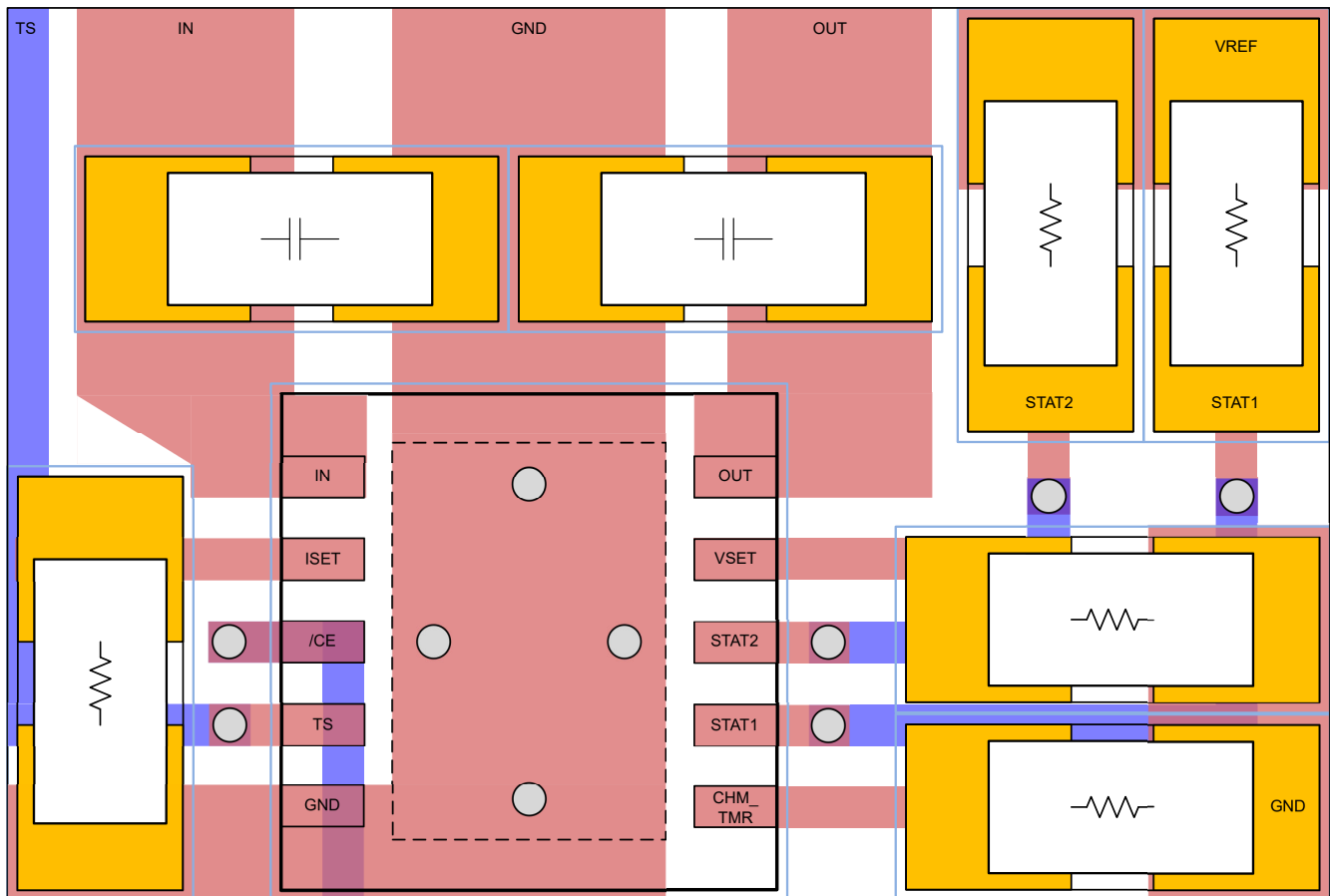


Figure 10-1. BQ25171-Q1 Board Layout Example

## 11 Device and Documentation Support

### 11.1 Device Support

#### 11.1.1 Third-Party Products Disclaimer

TI'S PUBLICATION OF INFORMATION REGARDING THIRD-PARTY PRODUCTS OR SERVICES DOES NOT CONSTITUTE AN ENDORSEMENT REGARDING THE SUITABILITY OF SUCH PRODUCTS OR SERVICES OR A WARRANTY, REPRESENTATION OR ENDORSEMENT OF SUCH PRODUCTS OR SERVICES, EITHER ALONE OR IN COMBINATION WITH ANY TI PRODUCT OR SERVICE.

#### 11.2 Receiving Notification of Documentation Updates

To receive notification of documentation updates, navigate to the device product folder on ti.com. In the upper right corner, click on *Alert me* to register and receive a weekly digest of any product information that has changed. For change details, review the revision history included in any revised document.

#### 11.3 Support Resources

[TI E2E™ support forums](#) are an engineer's go-to source for fast, verified answers and design help — straight from the experts. Search existing answers or ask your own question to get the quick design help you need.

Linked content is provided "AS IS" by the respective contributors. They do not constitute TI specifications and do not necessarily reflect TI's views; see TI's [Terms of Use](#).

#### 11.4 Trademarks

TI E2E™ is a trademark of Texas Instruments.

All trademarks are the property of their respective owners.

#### 11.5 Electrostatic Discharge Caution



This integrated circuit can be damaged by ESD. Texas Instruments recommends that all integrated circuits be handled with appropriate precautions. Failure to observe proper handling and installation procedures can cause damage.

ESD damage can range from subtle performance degradation to complete device failure. Precision integrated circuits may be more susceptible to damage because very small parametric changes could cause the device not to meet its published specifications.

#### 11.6 Glossary

[TI Glossary](#) This glossary lists and explains terms, acronyms, and definitions.



## 12 Mechanical, Packaging, and Orderable Information

The following pages include mechanical, packaging, and orderable information. This information is the most current data available for the designated devices. This data is subject to change without notice and revision of this document. For browser-based versions of this data sheet, refer to the left-hand navigation.

**PACKAGING INFORMATION**

Orderable Device	Status (1)	Package Type	Package Drawing	Pins	Package Qty	Eco Plan (2)	Lead finish/ Ball material (6)	MSL Peak Temp (3)	Op Temp (°C)	Device Marking (4/5)	Samples
BQ25171QWDRCRQ1	ACTIVE	VSON	DRC	10	3000	RoHS & Green	NIPDAU	Level-2-260C-1 YEAR	-40 to 125	B171Q	<b>Samples</b>

(1) The marketing status values are defined as follows:

**ACTIVE:** Product device recommended for new designs.

**LIFEBUY:** TI has announced that the device will be discontinued, and a lifetime-buy period is in effect.

**NRND:** Not recommended for new designs. Device is in production to support existing customers, but TI does not recommend using this part in a new design.

**PREVIEW:** Device has been announced but is not in production. Samples may or may not be available.

**OBSELETE:** TI has discontinued the production of the device.

(2) **RoHS:** TI defines "RoHS" to mean semiconductor products that are compliant with the current EU RoHS requirements for all 10 RoHS substances, including the requirement that RoHS substance do not exceed 0.1% by weight in homogeneous materials. Where designed to be soldered at high temperatures, "RoHS" products are suitable for use in specified lead-free processes. TI may reference these types of products as "Pb-Free".

**RoHS Exempt:** TI defines "RoHS Exempt" to mean products that contain lead but are compliant with EU RoHS pursuant to a specific EU RoHS exemption.

**Green:** TI defines "Green" to mean the content of Chlorine (Cl) and Bromine (Br) based flame retardants meet JS709B low halogen requirements of <=1000ppm threshold. Antimony trioxide based flame retardants must also meet the <=1000ppm threshold requirement.

(3) MSL, Peak Temp. - The Moisture Sensitivity Level rating according to the JEDEC industry standard classifications, and peak solder temperature.

(4) There may be additional marking, which relates to the logo, the lot trace code information, or the environmental category on the device.

(5) Multiple Device Markings will be inside parentheses. Only one Device Marking contained in parentheses and separated by a "-" will appear on a device. If a line is indented then it is a continuation of the previous line and the two combined represent the entire Device Marking for that device.

(6) Lead finish/Ball material - Orderable Devices may have multiple material finish options. Finish options are separated by a vertical ruled line. Lead finish/Ball material values may wrap to two lines if the finish value exceeds the maximum column width.

**Important Information and Disclaimer:**The information provided on this page represents TI's knowledge and belief as of the date that it is provided. TI bases its knowledge and belief on information provided by third parties, and makes no representation or warranty as to the accuracy of such information. Efforts are underway to better integrate information from third parties. TI has taken and continues to take reasonable steps to provide representative and accurate information but may not have conducted destructive testing or chemical analysis on incoming materials and chemicals. TI and TI suppliers consider certain information to be proprietary, and thus CAS numbers and other limited information may not be available for release.

In no event shall TI's liability arising out of such information exceed the total purchase price of the TI part(s) at issue in this document sold by TI to Customer on an annual basis.

**TAPE AND REEL INFORMATION**

**QUADRANT ASSIGNMENTS FOR PIN 1 ORIENTATION IN TAPE**


\*All dimensions are nominal

Device	Package Type	Package Drawing	Pins	SPQ	Reel Diameter (mm)	Reel Width W1 (mm)	A0 (mm)	B0 (mm)	K0 (mm)	P1 (mm)	W (mm)	Pin1 Quadrant
BQ25171QWDRCRQ1	VSON	DRC	10	3000	330.0	12.4	3.3	3.3	1.1	8.0	12.0	Q2

**TAPE AND REEL BOX DIMENSIONS**


\*All dimensions are nominal

Device	Package Type	Package Drawing	Pins	SPQ	Length (mm)	Width (mm)	Height (mm)
BQ25171QWDRCRQ1	VSON	DRC	10	3000	367.0	367.0	35.0

## GENERIC PACKAGE VIEW

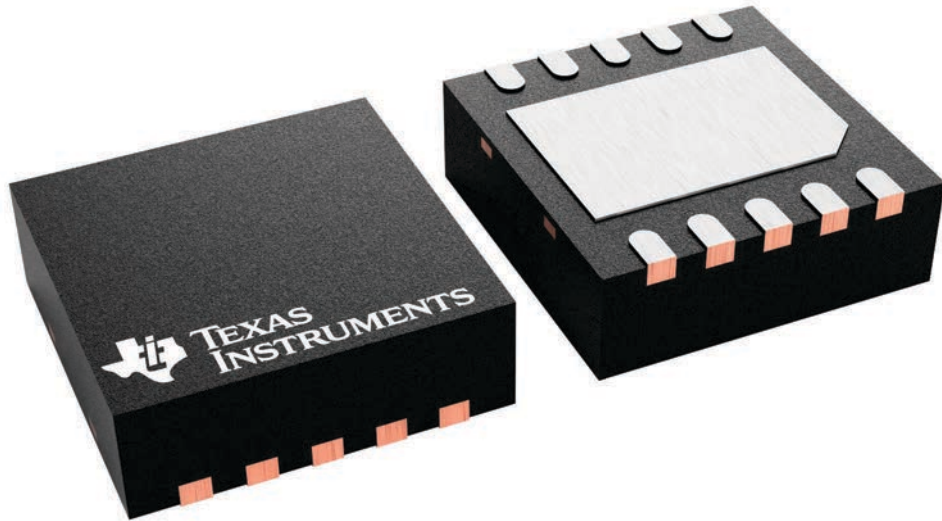
**DRC 10**

**VSON - 1 mm max height**

3 x 3, 0.5 mm pitch

PLASTIC SMALL OUTLINE - NO LEAD

This image is a representation of the package family, actual package may vary.  
Refer to the product data sheet for package details.



4226193/A

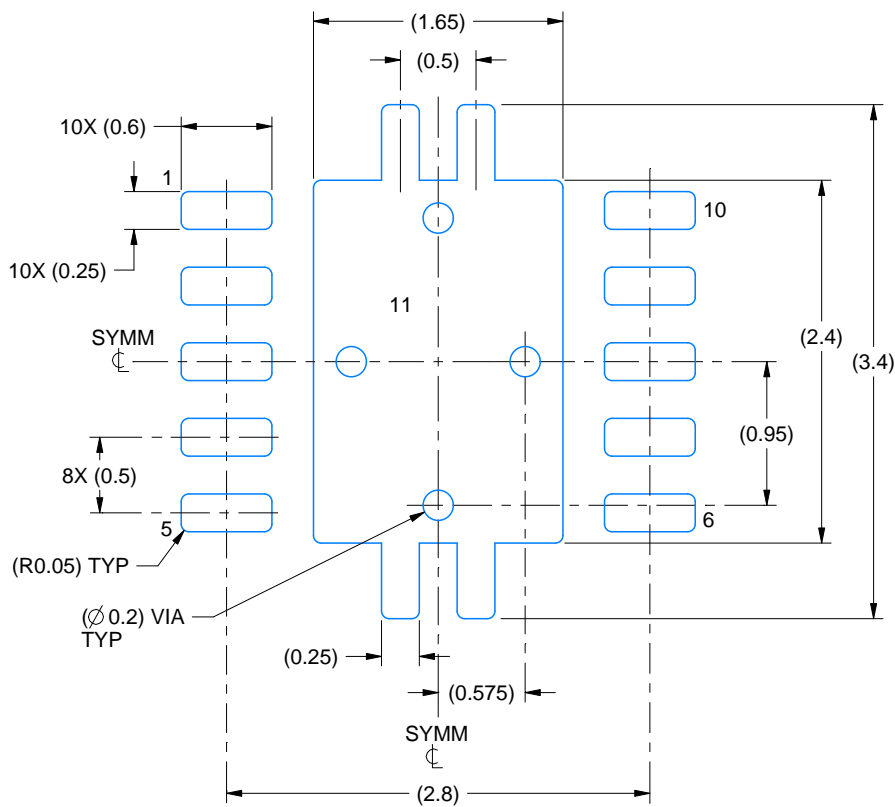


# EXAMPLE BOARD LAYOUT

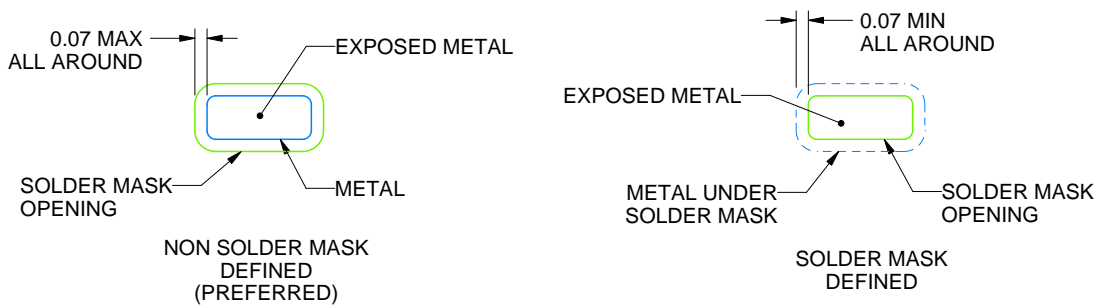
DRC0010U

VSON - 1 mm max height

PLASTIC SMALL OUTLINE - NO LEAD



LAND PATTERN EXAMPLE  
EXPOSED METAL SHOWN  
SCALE:20X



SOLDER MASK DETAILS

4225163/A 07/2019

NOTES: (continued)

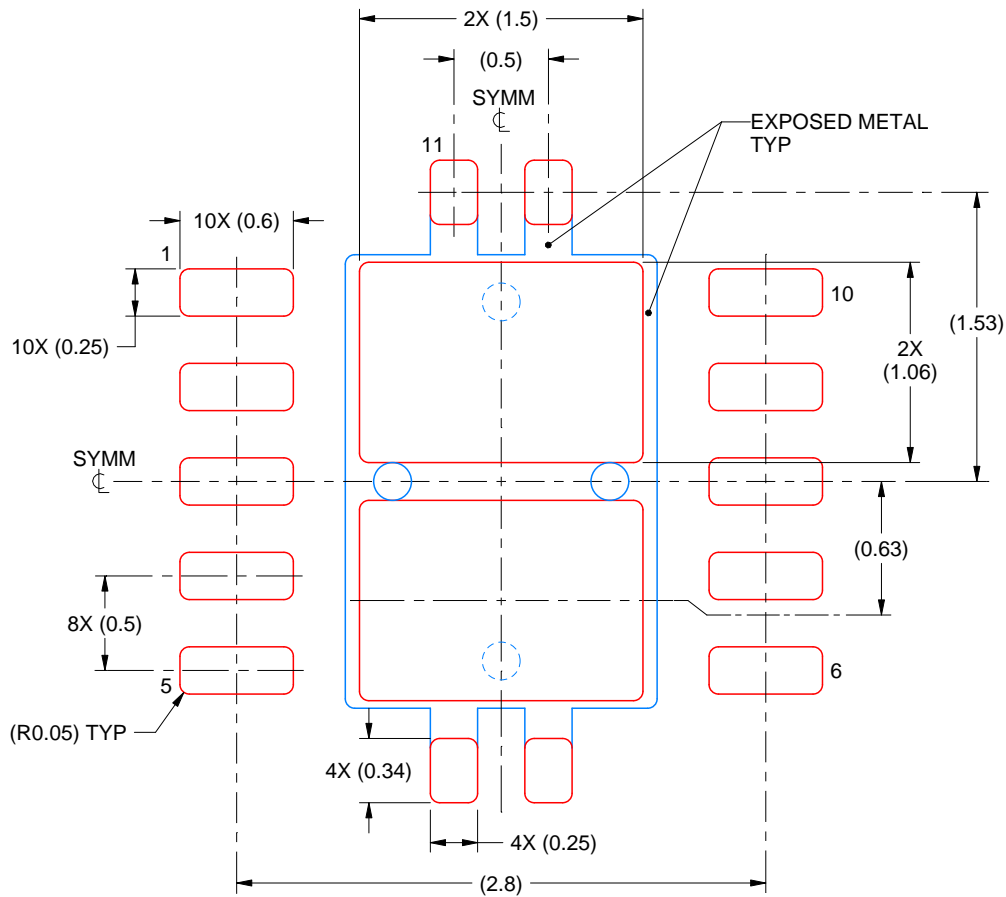
4. This package is designed to be soldered to a thermal pad on the board. For more information, see Texas Instruments literature number SLUA271 ([www.ti.com/lit/slua271](http://www.ti.com/lit/slua271)).
5. Vias are optional depending on application, refer to device data sheet. If any vias are implemented, refer to their locations shown on this view. It is recommended that vias under paste be filled, plugged or tented.

# EXAMPLE STENCIL DESIGN

DRC0010U

VSON - 1 mm max height

PLASTIC SMALL OUTLINE - NO LEAD



SOLDER PASTE EXAMPLE  
BASED ON 0.125 mm THICK STENCIL

EXPOSED PAD 11:  
80% PRINTED SOLDER COVERAGE BY AREA  
SCALE:25X

4225163/A 07/2019

NOTES: (continued)

6. Laser cutting apertures with trapezoidal walls and rounded corners may offer better paste release. IPC-7525 may have alternate design recommendations.



## IMPORTANT NOTICE AND DISCLAIMER

TI PROVIDES TECHNICAL AND RELIABILITY DATA (INCLUDING DATA SHEETS), DESIGN RESOURCES (INCLUDING REFERENCE DESIGNS), APPLICATION OR OTHER DESIGN ADVICE, WEB TOOLS, SAFETY INFORMATION, AND OTHER RESOURCES "AS IS" AND WITH ALL FAULTS, AND DISCLAIMS ALL WARRANTIES, EXPRESS AND IMPLIED, INCLUDING WITHOUT LIMITATION ANY IMPLIED WARRANTIES OF MERCHANTABILITY, FITNESS FOR A PARTICULAR PURPOSE OR NON-INFRINGEMENT OF THIRD PARTY INTELLECTUAL PROPERTY RIGHTS.

These resources are intended for skilled developers designing with TI products. You are solely responsible for (1) selecting the appropriate TI products for your application, (2) designing, validating and testing your application, and (3) ensuring your application meets applicable standards, and any other safety, security, regulatory or other requirements.

These resources are subject to change without notice. TI grants you permission to use these resources only for development of an application that uses the TI products described in the resource. Other reproduction and display of these resources is prohibited. No license is granted to any other TI intellectual property right or to any third party intellectual property right. TI disclaims responsibility for, and you will fully indemnify TI and its representatives against, any claims, damages, costs, losses, and liabilities arising out of your use of these resources.

TI's products are provided subject to [TI's Terms of Sale](#) or other applicable terms available either on [ti.com](http://ti.com) or provided in conjunction with such TI products. TI's provision of these resources does not expand or otherwise alter TI's applicable warranties or warranty disclaimers for TI products.

TI objects to and rejects any additional or different terms you may have proposed.

Mailing Address: Texas Instruments, Post Office Box 655303, Dallas, Texas 75265  
Copyright © 2022, Texas Instruments Incorporated