

# ESP32-S3 Series

## Datasheet

2.4 GHz Wi-Fi + Bluetooth® LE SoC

Supporting IEEE 802.11 b/g/n (2.4 GHz Wi-Fi) and Bluetooth® 5 (LE)

### Including:

ESP32-S3

ESP32-S3FN8

ESP32-S3R2

ESP32-S3R8

ESP32-S3R8V

ESP32-S3FH4R2



Version 1.6  
Espressif Systems  
Copyright © 2023

# Product Overview

ESP32-S3 is a low-power MCU-based system on a chip (SoC) with integrated 2.4 GHz Wi-Fi and Bluetooth® Low Energy (Bluetooth LE). It consists of high-performance dual-core microprocessor (Xtensa® 32-bit LX7), a low power coprocessor, a Wi-Fi baseband, a Bluetooth LE baseband, RF module, and numerous peripherals.

The functional block diagram of the SoC is shown below.

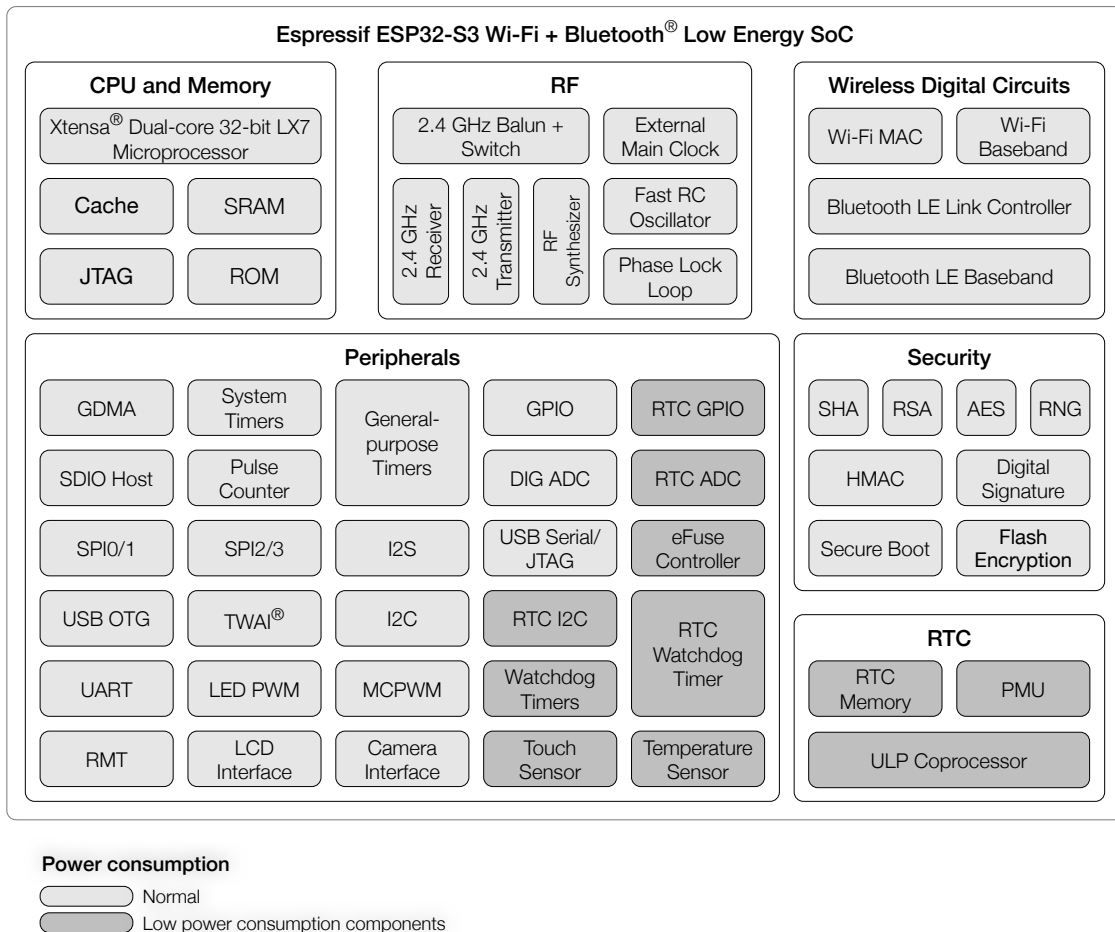

**ESP32-S3 Functional Block Diagram**

For more information on power consumption, see Section [3.2.1 Power Management Unit \(PMU\)](#).

# Features

## Wi-Fi

- IEEE 802.11 b/g/n-compliant
- Supports 20 MHz, 40 MHz bandwidth in 2.4 GHz band
- 1T1R mode with data rate up to 150 Mbps
- Wi-Fi Multimedia (WMM)
- TX/RX A-MPDU, TX/RX A-MSDU
- Immediate Block ACK
- Fragmentation and defragmentation
- Automatic Beacon monitoring (hardware TSF)
- 4 × virtual Wi-Fi interfaces
- Simultaneous support for Infrastructure BSS in Station, SoftAP, or Station + SoftAP modes  
Note that when ESP32-S3 scans in Station mode, the SoftAP channel will change along with the Station channel
- Antenna diversity
- 802.11mc FTM

## Bluetooth

- Bluetooth LE: Bluetooth 5, Bluetooth mesh
- High power mode (20 dBm)
- Speed: 125 Kbps, 500 Kbps, 1 Mbps, 2 Mbps
- Advertising extensions
- Multiple advertisement sets
- Channel selection algorithm #2
- Internal co-existence mechanism between Wi-Fi and Bluetooth to share the same antenna

## CPU and Memory

- Xtensa® dual-core 32-bit LX7 microprocessor, up to 240 MHz
- CoreMark® score:
  - 1 core at 240 MHz: 613.86 CoreMark; 2.56 CoreMark/MHz

- 2 cores at 240 MHz: 1181.60 CoreMark; 4.92 CoreMark/MHz

- 128-bit data bus and SIMD commands
- 384 KB ROM
- 512 KB SRAM
- 16 KB SRAM in RTC
- SPI, Dual SPI, Quad SPI, Octal SPI, QPI and OPI interfaces that allow connection to multiple flash and external RAM
- Flash controller with cache is supported
- Flash in-Circuit Programming (ICP) is supported

## Advanced Peripheral Interfaces

- 45 × programmable GPIOs
- Digital interfaces:
  - 4 × SPI
  - 1 × LCD interface (8-bit ~16-bit parallel RGB, I8080 and MOTO6800), supporting conversion between RGB565, YUV422, YUV420 and YUV411
  - 1 × DVP 8-bit ~16-bit camera interface
  - 3 × UART
  - 2 × I2C
  - 2 × I2S
  - 1 × RMT (TX/RX)
  - 1 × pulse counter
  - LED PWM controller, up to 8 channels
  - 1 × full-speed USB OTG
  - 1 × USB Serial/JTAG controller
  - 2 × MCPWM
  - 1 × SDIO host controller with 2 slots
  - General DMA controller (GDMA), with 5 transmit channels and 5 receive channels

- 1 × TWAI<sup>®</sup> controller, compatible with ISO 11898-1 (CAN Specification 2.0)
- Analog interfaces:
  - 2 × 12-bit SAR ADCs, up to 20 channels
  - 1 × temperature sensor
  - 14 × touch sensing IOs
- Timers:
  - 4 × 54-bit general-purpose timers
  - 1 × 52-bit system timer
  - 3 × watchdog timers

- ULP-RISC-V coprocessor
- ULP-FSM coprocessor

### Security

- Secure boot
- Flash encryption
- 4-Kbit OTP, up to 1792 bits for users
- Cryptographic hardware acceleration:
  - AES-128/256 (FIPS PUB 197)
  - Hash (FIPS PUB 180-4)
  - RSA
  - Random Number Generator (RNG)
  - HMAC
  - Digital signature

### Low Power Management

- Power Management Unit with five power modes
- Ultra-Low-Power (ULP) coprocessors:

## Applications

With low power consumption, ESP32-S3 is an ideal choice for IoT devices in the following areas:

- Smart Home
- Industrial Automation
- Health Care
- Consumer Electronics
- Smart Agriculture
- POS machines
- Service robot
- Audio Devices
- Generic Low-power IoT Sensor Hubs
- Generic Low-power IoT Data Loggers
- Cameras for Video Streaming
- USB Devices
- Speech Recognition
- Image Recognition
- Wi-Fi + Bluetooth Networking Card
- Touch and Proximity Sensing

**Note:**

Check the link or the QR code to make sure that you use the latest version of this document:  
[https://www.espressif.com/documentation/esp32-s3\\_datasheet\\_en.pdf](https://www.espressif.com/documentation/esp32-s3_datasheet_en.pdf)



# Contents

<b>Product Overview</b>	2
Features	3
Applications	4
<b>1 ESP32-S3 Series Comparison</b>	10
1.1 Nomenclature	10
1.2 Comparison	10
<b>2 Pins</b>	11
2.1 Pin Layout	11
2.2 Pin Overview	12
2.3 IO Pins	16
2.3.1 IO MUX and GPIO Pin Functions	16
2.3.2 RTC and Analog Pin Functions	19
2.3.3 Restrictions for GPIOs and RTC_GPIOs	20
2.4 Analog Pins	20
2.5 Power Supply	21
2.5.1 Power Pins	21
2.5.2 Power Scheme	21
2.5.3 Chip Power-up and Reset	22
2.6 Strapping Pins	23
2.6.1 Chip Boot Mode Control	24
2.6.2 VDD_SPI Voltage Control	24
2.6.3 ROM Messages Printing Control	25
2.6.4 JTAG Signal Source Control	25
2.7 Pin Mapping Between Chip and Flash/PSRAM	26
<b>3 Functional Description</b>	27
3.1 CPU and Memory	27
3.1.1 CPU	27
3.1.2 Internal Memory	27
3.1.3 External Flash and RAM	27
3.1.4 Address Mapping Structure	28
3.1.5 Cache	29
3.1.6 eFuse Controller	29
3.1.7 Processor Instruction Extensions	29

3.2	RTC and Low-Power Management	30
3.2.1	Power Management Unit (PMU)	30
3.2.2	Ultra-Low-Power Coprocessor	32
3.3	Analog Peripherals	32
3.3.1	Analog-to-Digital Converter (ADC)	32
3.3.2	Temperature Sensor	32
3.3.3	Touch Sensor	32
3.4	System Components	33
3.4.1	Reset and Clock	33
3.4.2	Interrupt Matrix	33
3.4.3	Permission Control	33
3.4.4	System Registers	34
3.4.5	GDMA Controller	35
3.4.6	CPU Clock	35
3.4.7	RTC Clock	35
3.4.8	Clock Glitch Detection	35
3.5	Digital Peripherals	36
3.5.1	IO MUX and GPIO Matrix	36
3.5.2	Serial Peripheral Interface (SPI)	36
3.5.3	LCD Interface	38
3.5.4	Camera Interface	38
3.5.5	UART Controller	38
3.5.6	I2C Interface	39
3.5.7	I2S Interface	39
3.5.8	Remote Control Peripheral	39
3.5.9	Pulse Count Controller	40
3.5.10	LED PWM Controller	40
3.5.11	USB 2.0 OTG Full-Speed Interface	41
3.5.12	USB Serial/JTAG Controller	41
3.5.13	Motor Control PWM (MCPWM)	42
3.5.14	SD/MMC Host Controller	42
3.5.15	TWA <sup>®</sup> Controller	42
3.6	Radio and Wi-Fi	43
3.6.1	2.4 GHz Receiver	43
3.6.2	2.4 GHz Transmitter	43
3.6.3	Clock Generator	44
3.6.4	Wi-Fi Radio and Baseband	44
3.6.5	Wi-Fi MAC	44
3.6.6	Networking Features	45
3.7	Bluetooth LE	45
3.7.1	Bluetooth LE Radio and PHY	45
3.7.2	Bluetooth LE Link Layer Controller	45
3.8	Timers and Watchdogs	46
3.8.1	General Purpose Timers	46
3.8.2	System Timer	46
3.8.3	Watchdog Timers	46

3.8.4	XTAL32K Watchdog Timers	47
3.9	Cryptography/Security Components	47
3.9.1	External Memory Encryption and Decryption	47
3.9.2	Secure Boot	48
3.9.3	HMAC Accelerator	48
3.9.4	Digital Signature	48
3.9.5	World Controller	48
3.9.6	SHA Accelerator	48
3.9.7	AES Accelerator	49
3.9.8	RSA Accelerator	49
3.9.9	Random Number Generator	50
3.10	Peripheral Pin Configurations	50
<b>4</b>	<b>Electrical Characteristics</b>	<b>56</b>
4.1	Absolute Maximum Ratings	56
4.2	Recommended Power Supply Characteristics	56
4.3	VDD_SPI Output Characteristics	57
4.4	DC Characteristics (3.3 V, 25 °C)	57
4.5	ADC Characteristics	58
4.6	Current Consumption	58
4.6.1	RF Current Consumption in Active Mode	58
4.6.2	Current Consumption in Other Modes	58
4.7	Reliability	60
4.8	Wi-Fi Radio	61
4.8.1	Wi-Fi RF Transmitter (TX) Specifications	61
4.8.2	Wi-Fi RF Receiver (RX) Specifications	62
4.9	Bluetooth LE Radio	63
4.9.1	Bluetooth LE RF Transmitter (TX) Specifications	63
4.9.2	Bluetooth LE RF Receiver (RX) Specifications	65
<b>5</b>	<b>Packaging</b>	<b>68</b>
<b>6</b>	<b>Related Documentation and Resources</b>	<b>70</b>
	<b>Appendix A – ESP32-S3 Consolidated Pin Overview</b>	<b>71</b>
	<b>Revision History</b>	<b>72</b>

## List of Tables

1-1	ESP32-S3 Series Comparison	10
2-1	Pin Overview	13
2-2	Power-Up Glitches on Pins	14
2-3	IO MUX Pin Functions	17
2-4	RTC and Analog Functions	19
2-5	Analog Pins	20
2-6	Power Pins	21
2-7	Voltage Regulators	21
2-8	Description of Timing Parameters for Power-up and Reset	22
2-9	Default Configuration of Strapping Pins	23
2-10	Description of Timing Parameters for the Strapping Pins	23
2-11	Chip Boot Mode Control	24
2-12	VDD_SPI Voltage Control	24
2-13	JTAG Signal Source Control	25
2-14	Pin Mapping Between Chip and In-package Flash/ PSRAM	26
3-1	Components and Power Domains	31
3-2	SPI Pin Configuration	38
3-3	Peripheral Pin Configurations	50
4-1	Absolute Maximum Ratings	56
4-2	Recommended Power Characteristics	56
4-3	VDD_SPI Internal and Output Characteristics	57
4-4	DC Characteristics (3.3 V, 25 °C)	57
4-5	ADC Characteristics	58
4-6	Wi-Fi Current Consumption Depending on RF Modes	58
4-7	Current Consumption in Modem-sleep Mode	59
4-8	Current Consumption in Low-Power Modes	59
4-9	Reliability Qualifications	60
4-10	Wi-Fi Frequency	61
4-11	TX Power with Spectral Mask and EVM Meeting 802.11 Standards	61
4-12	TX EVM Test	61
4-13	RX Sensitivity	62
4-14	Maximum RX Level	62
4-15	RX Adjacent Channel Rejection	63
4-16	Bluetooth LE Frequency	63
4-17	Transmitter Characteristics - Bluetooth LE 1 Mbps	63
4-18	Transmitter Characteristics - Bluetooth LE 2 Mbps	64
4-19	Transmitter Characteristics - Bluetooth LE 125 Kbps	64
4-20	Transmitter Characteristics - Bluetooth LE 500 Kbps	64
4-21	Receiver Characteristics - Bluetooth LE 1 Mbps	65
4-22	Receiver Characteristics - Bluetooth LE 2 Mbps	66
4-23	Receiver Characteristics - Bluetooth LE 125 Kbps	66
4-24	Receiver Characteristics - Bluetooth LE 500 Kbps	67



## List of Figures

1-1	ESP32-S3 Series Nomenclature	10
2-1	ESP32-S3 Pin Layout (Top View)	11
2-2	ESP32-S3 Power Scheme	22
2-3	Visualization of Timing Parameters for Power-up and Reset	22
2-4	Visualization of Timing Parameters for the Strapping Pins	24
3-1	Address Mapping Structure	28
3-2	Components and Power Domains	31
5-1	QFN56 (7×7 mm) Package	68
5-2	QFNWB (7×7 mm) Package for ESP32-S3FH4R2	69

# 1 ESP32-S3 Series Comparison

## 1.1 Nomenclature

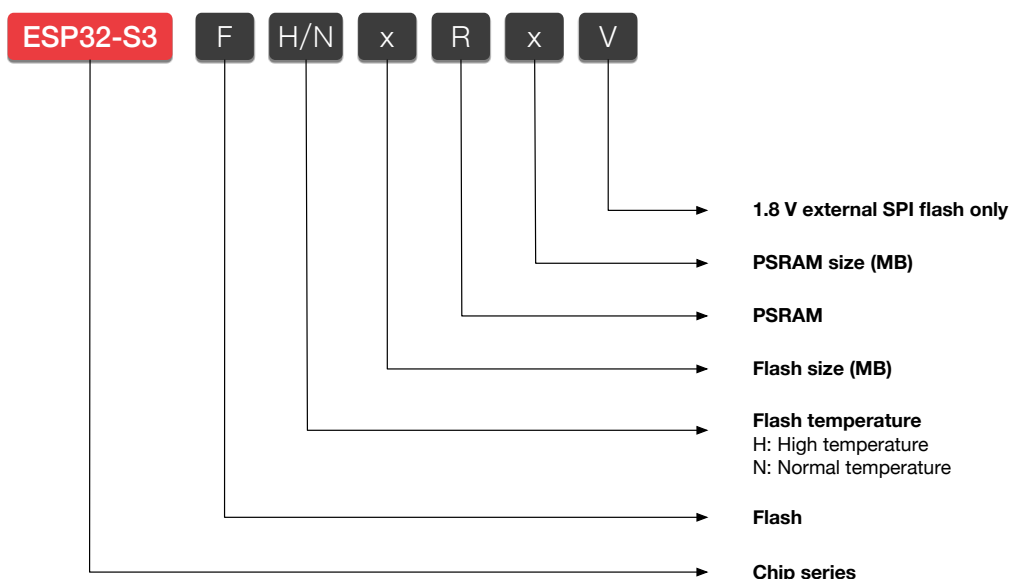

Figure 1-1. ESP32-S3 Series Nomenclature

## 1.2 Comparison

Table 1-1. ESP32-S3 Series Comparison

Ordering Code <sup>1</sup>	In-Package Flash	In-Package PSRAM	Ambient Temp. <sup>2</sup> (°C)	VDD_SPI Voltage <sup>3</sup>
ESP32-S3	—	—	-40 ~ 105	3.3 V/1.8 V
ESP32-S3FN8	8 MB (Quad SPI) <sup>4</sup>	—	-40 ~ 85	3.3 V
ESP32-S3R2	—	2 MB (Quad SPI)	-40 ~ 85	3.3 V
ESP32-S3R8	—	8 MB (Octal SPI)	-40 ~ 65	3.3 V
ESP32-S3R8V	—	8 MB (Octal SPI)	-40 ~ 65	1.8 V
ESP32-S3FH4R2 <sup>5</sup>	4 MB (Quad SPI)	2 MB (Quad SPI)	-40 ~ 85	3.3 V

<sup>1</sup> For details on chip marking and packing, see Section 5 Packaging.

<sup>2</sup> Ambient temperature specifies the recommended temperature range of the environment immediately outside an Espressif chip. For ESP32-S3R8 and ESP32-S3R8V chips, if the PSRAM ECC function is enabled, the maximum ambient temperature can be improved to 85 °C, while the usable size of PSRAM will be reduced by 1/16.

<sup>3</sup> For more information on VDD\_SPI, see Section 2.5 Power Supply.

<sup>4</sup> For details about SPI modes, see Section 2.7 Pin Mapping Between Chip and Flash/PSRAM.

<sup>5</sup> The ESP32-S3FH4R2 chip is still in sample status.

## 2 Pins

### 2.1 Pin Layout

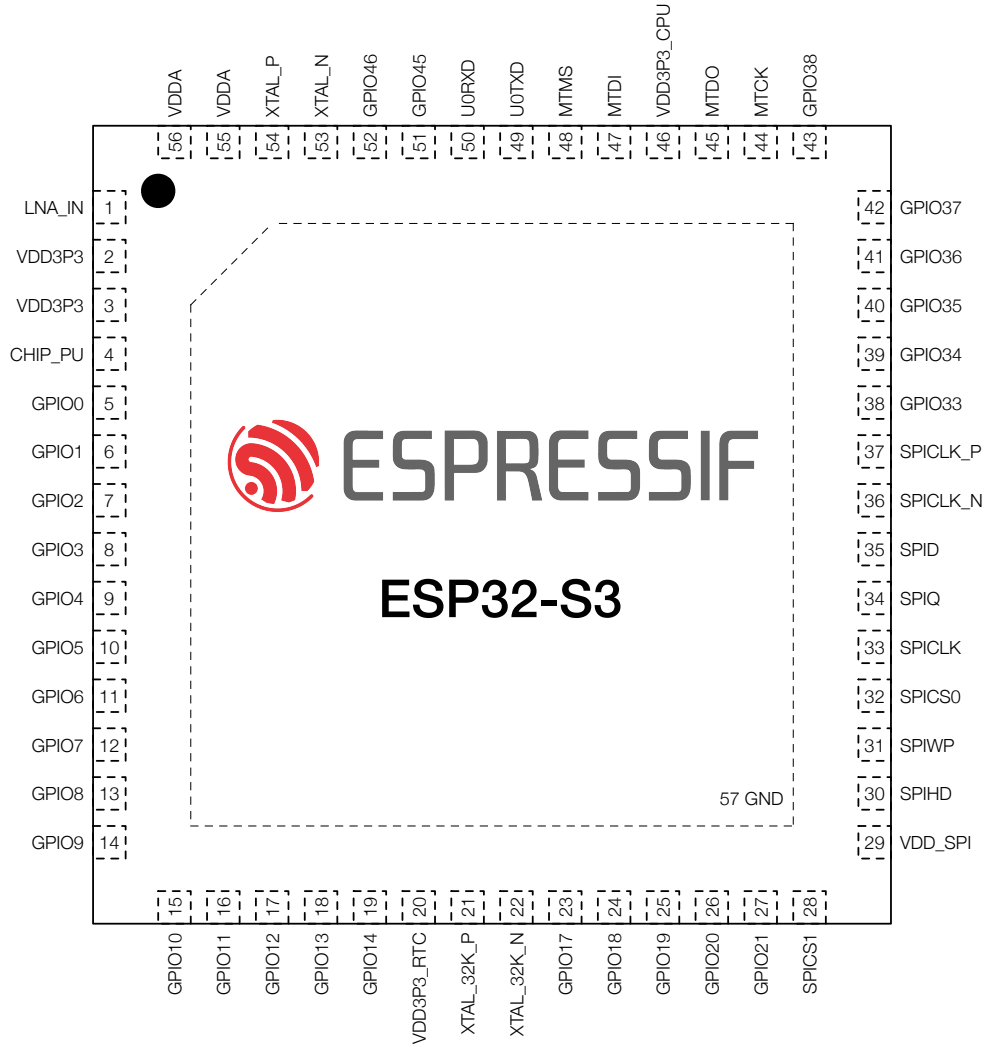

Figure 2-1. ESP32-S3 Pin Layout (Top View)

## 2.2 Pin Overview

The ESP32-S3 chip integrates multiple peripherals that require communication with the outside world. To keep the chip package size reasonably small, the number of available pins has to be limited. So the only way to route all the incoming and outgoing signals is through pin multiplexing. Pin muxing is controlled via software programmable registers (see [ESP32-S3 Technical Reference Manual](#) > Chapter *IO MUX and GPIO Matrix*).

All in all, the ESP32-S3 chip has the following types of pins:

- **IO pins** with the following predefined sets of functions to choose from:
  - **Each** IO pin has predefined **IO MUX and GPIO functions** – see Table [2-3 IO MUX and GPIO Pin Functions](#)
  - **Some** IO pins have predefined **RTC functions** – see Table [2-4 RTC and Analog Pin Functions](#)
  - **Some** IO pins have predefined **analog functions** – see Table [2-4 RTC and Analog Pin Functions](#)

*Predefined functions* means that each IO pin has a set of direct connections to certain on-chip components. During run-time, the user can configure which component from a predefined set to connect to a certain pin at a certain time via memory mapped registers (see [ESP32-S3 Technical Reference Manual](#) > Chapter *IO MUX and GPIO pins*).

- **Analog pins** that have exclusively-dedicated **analog functions** – see Table [2-5 Analog Pins](#)
- **Power pins** supply power to the chip components and non-power pins – see Table [2-6 Power Pins](#)

**Notes for Table 2-1 Pin Overview** (see below):

1. For more information, see respective sections below. Alternatively, see [Appendix A – ESP32-S3 Consolidated Pin Overview](#).
2. **Bold** marks the pin function set in which a pin has its default function in the default boot mode. See Section [2.6.1 Chip Boot Mode Control](#). For pins No.38 ~ 42, the default function is decided by eFuse bit (see [ESP32-S3 Technical Reference Manual](#) > Chapter *eFuse Controller*).
3. In column **Pin Providing Power**, regarding pins powered by VDD\_SPI:
  - Power actually comes from the internal power rail supplying power to VDD\_SPI. For details, see Section [2.5.2 Power Scheme](#).
4. In column **Pin Providing Power**, regarding pins powered by VDD3P3\_CPU / VDD\_SPI:
  - Pin Providing Power (either VDD3P3\_CPU or VDD\_SPI) can be configured via a register, see [ESP32-S3 Technical Reference Manual](#) > Chapter *IO MUX and GPIO pins*.
5. For ESP32-S3R8V chip, as the VDD\_SPI voltage has been set to 1.8 V, the working voltage for pins SPICLK\_N and SPICLK\_P (GPIO47 and GPIO48) would also be 1.8 V, which is different from other GPIOs.
6. Default drive strength for all pins is 20 mA.
7. Column **Pin Settings** shows predefined settings at reset and after reset with the following abbreviations:
  - IE – input enabled
  - WPU – internal weak pull-up resistor enabled
  - WPD – internal weak pull-down resistor enabled

8. Depends on the value of EFUSE\_DIS\_PAD\_JTAG

- 0 - pin floating
- 1 - WPU is enabled

**Table 2-1. Pin Overview**

Pin No.	Pin Name	Pin Type <sup>1</sup>	Pin Providing Power <sup>3-6</sup>	Pin Settings <sup>7</sup>		Pin Function Sets <sup>1,2</sup>		
				At Reset	After Reset	IO MUX	RTC	Analog
1	LNA_IN	Analog						
2	VDD3P3	Power						
3	VDD3P3	Power						
4	CHIP_PU	Analog	VDD3P3_RTC					
5	GPIO0	IO	VDD3P3_RTC	IE, WPU	IE, WPU	IO MUX	RTC	
6	GPIO1	IO	VDD3P3_RTC	IE	IE	IO MUX	RTC	Analog
7	GPIO2	IO	VDD3P3_RTC	IE	IE	IO MUX	RTC	Analog
8	GPIO3	IO	VDD3P3_RTC	IE	IE	IO MUX	RTC	Analog
9	GPIO4	IO	VDD3P3_RTC			IO MUX	RTC	Analog
10	GPIO5	IO	VDD3P3_RTC			IO MUX	RTC	Analog
11	GPIO6	IO	VDD3P3_RTC			IO MUX	RTC	Analog
12	GPIO7	IO	VDD3P3_RTC			IO MUX	RTC	Analog
13	GPIO8	IO	VDD3P3_RTC			IO MUX	RTC	Analog
14	GPIO9	IO	VDD3P3_RTC		IE	IO MUX	RTC	Analog
15	GPIO10	IO	VDD3P3_RTC		IE	IO MUX	RTC	Analog
16	GPIO11	IO	VDD3P3_RTC		IE	IO MUX	RTC	Analog
17	GPIO12	IO	VDD3P3_RTC		IE	IO MUX	RTC	Analog
18	GPIO13	IO	VDD3P3_RTC		IE	IO MUX	RTC	Analog
19	GPIO14	IO	VDD3P3_RTC		IE	IO MUX	RTC	Analog
20	VDD3P3_RTC	Power						
21	XTAL_32K_P	IO	VDD3P3_RTC			IO MUX	RTC	Analog
22	XTAL_32K_N	IO	VDD3P3_RTC			IO MUX	RTC	Analog
23	GPIO17	IO	VDD3P3_RTC		IE	IO MUX	RTC	Analog
24	GPIO18	IO	VDD3P3_RTC		IE	IO MUX	RTC	Analog
25	GPIO19	IO	VDD3P3_RTC			IO MUX	RTC	<b>Analog</b>
26	GPIO20	IO	VDD3P3_RTC			IO MUX	RTC	<b>Analog</b>
27	GPIO21	IO	VDD3P3_RTC			IO MUX	RTC	
28	SPICS1	IO	VDD_SPI	IE, WPU	IE, WPU	IO MUX		
29	VDD_SPI	Power						
30	SPIHD	IO	VDD_SPI	IE, WPU	IE, WPU	IO MUX		
31	SPIWP	IO	VDD_SPI	IE, WPU	IE, WPU	IO MUX		
32	SPICS0	IO	VDD_SPI	IE, WPU	IE, WPU	IO MUX		
33	SPICLK	IO	VDD_SPI	IE, WPU	IE, WPU	IO MUX		
34	SPIQ	IO	VDD_SPI	IE, WPU	IE, WPU	IO MUX		
35	SPID	IO	VDD_SPI	IE, WPU	IE, WPU	IO MUX		
36	SPICLK_N	IO	VDD_SPI / VDD3P3_CPU	IE	IE	IO MUX		
37	SPICLK_P	IO	VDD_SPI / VDD3P3_CPU	IE	IE	IO MUX		
38	GPIO33	IO	VDD_SPI / VDD3P3_CPU		IE	IO MUX		
39	GPIO34	IO	VDD_SPI / VDD3P3_CPU		IE	IO MUX		

Cont'd on next page

Table 2-1 – cont'd from previous page

Pin No.	Pin Name	Pin Type <sup>1</sup>	Pin Providing Power <sup>3-6</sup>	Pin Settings <sup>7</sup>		Pin Function Sets <sup>1,2</sup>		
				At Reset	After Reset	IO MUX	RTC	Analog
40	GPIO35	IO	VDD_SPI / VDD3P3_CPU		IE	IO MUX		
41	GPIO36	IO	VDD_SPI / VDD3P3_CPU		IE	IO MUX		
42	GPIO37	IO	VDD_SPI / VDD3P3_CPU		IE	IO MUX		
43	GPIO38	IO	VDD3P3_CPU		IE	IO MUX		
44	MTCK	IO	VDD3P3_CPU		IE <sup>8</sup>	IO MUX		
45	MTDO	IO	VDD3P3_CPU		IE	IO MUX		
46	VDD3P3_CPU	Power						
47	MTDI	IO	VDD3P3_CPU		IE	IO MUX		
48	MTMS	IO	VDD3P3_CPU		IE	IO MUX		
49	U0TXD	IO	VDD3P3_CPU	IE, WPU	IE, WPU	IO MUX		
50	U0RXD	IO	VDD3P3_CPU	IE, WPU	IE, WPU	IO MUX		
51	GPIO45	IO	VDD3P3_CPU	IE, WPD	IE, WPD	IO MUX		
52	GPIO46	IO	VDD3P3_CPU	IE, WPD	IE, WPD	IO MUX		
53	XTAL_N	Analog						
54	XTAL_P	Analog						
55	VDDA	Power						
56	VDDA	Power						
57	GND	Power						

Some pins have glitches during power-up. See details in Table 2-2.

Table 2-2. Power-Up Glitches on Pins

Pin	Glitch <sup>1</sup>	Typical Time Period ( $\mu$ s)
GPIO1	Low-level glitch	60
GPIO2	Low-level glitch	60
GPIO3	Low-level glitch	60
GPIO4	Low-level glitch	60
GPIO5	Low-level glitch	60
GPIO6	Low-level glitch	60
GPIO7	Low-level glitch	60
GPIO8	Low-level glitch	60
GPIO9	Low-level glitch	60
GPIO10	Low-level glitch	60
GPIO11	Low-level glitch	60
GPIO12	Low-level glitch	60
GPIO13	Low-level glitch	60
GPIO14	Low-level glitch	60
XTAL_32K_P	Low-level glitch	60
XTAL_32K_N	Low-level glitch	60
GPIO17	Low-level glitch	60
GPIO18	Low-level glitch	60
	High-level glitch	60

GPIO19	Low-level glitch	60
	High-level glitch <sup>2</sup>	60
GPIO20	Pull-down glitch	60
	High-level glitch <sup>2</sup>	60

<sup>1</sup> Low-level glitch: the pin is at a low level output status during the time period;

High-level glitch: the pin is at a high level output status during the time period;

Pull-down glitch: the pin is at an internal weak pulled-down status during the time period;

Pull-up glitch: the pin is at an internal weak pulled-up status during the time period.

Please refer to Table 4-4 for detailed parameters about low/high-level and pull-down/up.

<sup>2</sup> GPIO19 and GPIO20 pins both have two high-level glitches during chip power-up, each lasting for about 60  $\mu$ s. The total duration for the glitches and the delay are 3.2 ms and 2 ms respectively for GPIO19 and GPIO20.

## 2.3 IO Pins

### 2.3.1 IO MUX and GPIO Pin Functions

The pins of ESP32-S3 can be assigned any function (F0-F4) from their respective sets of IO MUX functions as listed in Table 2-3 *IO MUX and GPIO Pin Functions*.

Each set of the IO MUX functions has a general purpose input/output (**GPIO0, GPIO1, etc.**) function. If a pin is assigned a GPIO function, this pin's signal is routed via the GPIO matrix, which incorporates internal signal routing circuitry for mapping signals programmatically. It gives the pin access to almost any IO MUX function. However, the flexibility of programmatic mapping comes at a cost as it might affect speed and latency of routed signals.

#### Notes for Table 2-3 IO MUX and GPIO Pin Functions:

- 1.** **Bold** marks the default pin functions in the default boot mode. See Section 2.6.1 *Chip Boot Mode Control*.
- Regarding **highlighted** cells, see Section 2.3.3 *Restrictions for GPIOs and RTC\_GPIOs*.
- Each IO MUX function ( $F_n$ ,  $n = 0 \sim 4$ ) is associated with a *type*. The description of *type* is as follows:
  - I – input. O – output. T – high impedance.
  - I1 – input; if the pin is assigned a function other than  $F_n$ , the input signal of  $F_n$  is always 1.
  - IO – input; if the pin is assigned a function other than  $F_n$ , the input signal of  $F_n$  is always 0.

#### 4. Function names:

CLK_OUT...	Clock output for debugging.
GPIO...	General-purpose input/output with signals routed via the GPIO matrix. For more details on the GPIO matrix, see <a href="#">ESP32-S3 Technical Reference Manual</a> > Chapter <i>IO MUX and GPIO Matrix</i> .
SPICLK_N_DIFF	} Serial peripheral interface differential clock negative/positive for SPI bus.
SPICLK_P_DIFF	
SUBSPICLK_N_DIFF	} Serial peripheral interface differential clock negative/positive for SUBSPI bus.
SUBSPICLK_P_DIFF	
U...RTS	} UART0/1 hardware flow control signals.
U...CTS	
U...RXD	} UART0/1 receive/transmit signals.
U...TXD	

#### 5. Groups of functions (see the markings in the table):

- JTAG interface for debugging.
- UART interface for debugging.
- SPI0/1 interface for connection to in-package or off-package flash/PSRAM via SPI bus. See also Section 2.7 *Pin Mapping Between Chip and Flash/PSRAM*.
- SPI0/1 interface signal lines for Octal SPI connection.
- SPI2 main interface for fast SPI connection.
- SPI0/1 interface for connection to in-package or off-package flash/PSRAM via SUBSPI bus (separate bus for voltages differing from SPI bus). Note that the fast SPI2 interface will not be available.



- g. SPI0/1 interface for connection via SUBSPI bus – alternative group of signal lines that can be used if SPI0/1 does not use Octal SPI connection.
- h. (not recommended) Alternative SPI2 interface if the main SPI2 is not available. Its performance is comparable to SPI2 via GPIO matrix, so use the GPIO matrix instead. See Section 3.5.2 Serial Peripheral Interface (SPI).
- i. (not recommended) Alternative SPI2 interface signal lines for Octal SPI connection.

**Table 2-3. IO MUX Pin Functions**

Pin No.	IO MUX / GPIO Name	IO MUX Function									
		0	Type	1	Type	2	Type	3	Type	4	Type
5	GPIO0	GPIO0	I/O/T	GPIO0	I/O/T						
6	GPIO1	GPIO1	I/O/T	GPIO1	I/O/T						
7	GPIO2	GPIO2	I/O/T	GPIO2	I/O/T						
8	GPIO3	GPIO3	I/O/T	GPIO3	I/O/T						
9	GPIO4	GPIO4	I/O/T	GPIO4	I/O/T						
10	GPIO5	GPIO5	I/O/T	GPIO5	I/O/T						
11	GPIO6	GPIO6	I/O/T	GPIO6	I/O/T						
12	GPIO7	GPIO7	I/O/T	GPIO7	I/O/T						
13	GPIO8	GPIO8	I/O/T	GPIO8	I/O/T			SUBSPICS1	O/T		
14	GPIO9	GPIO9	I/O/T	GPIO9	I/O/T			SUBSPIHD	I1/O/T	FSPiHD	I1/O/T
15	GPIO10	GPIO10	I/O/T	GPIO10	I/O/T	FSPiIO4	I1/O/T	SUBSPICS0	O/T	FSPICS0	I1/O/T
16	GPIO11	GPIO11	I/O/T	GPIO11	I/O/T	FSPiIO5	I1/O/T	SUBSPID	I1/O/T	FSPID	I1/O/T
17	GPIO12	GPIO12	I/O/T	GPIO12	I/O/T	FSPiIO6	I1/O/T	SUBSPICLK	O/T	FSPICLK	I1/O/T
18	GPIO13	GPIO13	I/O/T	GPIO13	I/O/T	FSPiIO7	I1/O/T	SUBSPIQ	I1/O/T	FSPiQ	I1/O/T
19	GPIO14	GPIO14	I/O/T	GPIO14	I/O/T	FSPIDQS	O/T	SUBSPiWP	I1/O/T	FSPiWP	I1/O/T
21	GPIO15	GPIO15	I/O/T	GPIO15	I/O/T	U0RTS	O				
22	GPIO16	GPIO16	I/O/T	GPIO16	I/O/T	U0CTS	I1				
23	GPIO17	GPIO17	I/O/T	GPIO17	I/O/T	U1TXD	O				
24	GPIO18	GPIO18	I/O/T	GPIO18	I/O/T	U1RXD	I1	CLK_OUT3	O		
25	GPIO19	GPIO19	I/O/T	GPIO19	I/O/T	U1RTS	O	CLK_OUT2	O		
26	GPIO20	GPIO20	I/O/T	GPIO20	I/O/T	U1CTS	I1	CLK_OUT1	O		
27	GPIO21	GPIO21	I/O/T	GPIO21	I/O/T						
28	GPIO26	SPICS1	O/T	GPIO26	I/O/T						
30	GPIO27	SPIHD	I1/O/T	GPIO27	I/O/T						
31	GPIO28	SPIWP	I1/O/T	GPIO28	I/O/T						
32	GPIO29	SPICS0	O/T	GPIO29	I/O/T						
33	GPIO30	SPICLK	O/T	GPIO30	I/O/T						
34	GPIO31	SPIQ	I1/O/T	GPIO31	I/O/T						
35	GPIO32	SPID	I1/O/T	GPIO32	I/O/T						

Cont'd on next page

Table 2-3 – cont'd from previous page

Pin No.	IO MUX / GPIO Name	IO MUX Function									
		0	Type	1	Type	2	Type	3	Type	4	Type
38	GPIO33	GPIO33	I/O/T	<b>GPIO33</b>	I/O/T	FSPiHD <sup>5h</sup>	I1/O/T	SUBSPiHD <sup>5g</sup>	I1/O/T	SPIIO4 <sup>5d</sup>	I1/O/T
39	GPIO34	GPIO34	I/O/T	<b>GPIO34</b>	I/O/T	FSPiCS0	I1/O/T	SUBSPiCS0	O/T	SPIIO5	I1/O/T
40	GPIO35	GPIO35	I/O/T	<b>GPIO35</b>	I/O/T	FSPiD	I1/O/T	SUBSPiD	I1/O/T	SPIIO6	I1/O/T
41	GPIO36	GPIO36	I/O/T	<b>GPIO36</b>	I/O/T	FSPiCLK	I1/O/T	SUBSPiCLK	O/T	SPIIO7	I1/O/T
42	GPIO37	GPIO37	I/O/T	<b>GPIO37</b>	I/O/T	FSPiQ	I1/O/T	SUBSPiQ	I1/O/T	SPiDQS	I0/O/T
43	GPIO38	GPIO38	I/O/T	<b>GPIO38</b>	I/O/T	FSPiWP	I1/O/T	SUBSPiWP	I1/O/T		
44	GPIO39	MTCK <sup>5a</sup>	I1	GPIO39	I/O/T	CLK_OUT3	O	SUBSPiCS1	O/T		
45	GPIO40	MTDO	O/T	GPIO40	I/O/T	CLK_OUT2	O				
47	GPIO41	MTDI	I1	GPIO41	I/O/T	CLK_OUT1	O				
48	GPIO42	MTMS <sup>5b</sup>	I1	GPIO42	I/O/T						
49	GPIO43	U0TXD	O	GPIO43	I/O/T	CLK_OUT1	O				
50	GPIO44	U0RXD	I1	GPIO44	I/O/T	CLK_OUT2	O				
51	GPIO45	GPIO45	I/O/T	<b>GPIO45</b>	I/O/T						
52	GPIO46	GPIO46	I/O/T	<b>GPIO46</b>	I/O/T						
37	GPIO47	SPI CLK_P_DIFF	O/T	<b>GPIO47</b>	I/O/T	SUBSPi CLK_DIFF	O/T				
36	GPIO48	SPI CLK_N_DIFF	O/T	<b>GPIO48</b>	I/O/T	SUBSPi CLK_DIFF	O/T				

## 2.3.2 RTC and Analog Pin Functions

RTC and Analog pin functions, as well as the hardware behind them, are powered by the same power pin, so these pin functions are somewhat related and covered together.

### Notes for Table 2-4 RTC and Analog Pin Functions:

- Bold** marks the default pin functions in the default boot mode. See Section 2.6.1 Chip Boot Mode Control.
- Regarding **highlighted** cells, see Section 2.3.3 Restrictions for GPIOs and RTC\_GPIOs.
- Function names:

RTC_GPIO...	RTC general purpose input/output connected to the ULP coprocessor.
sar_i2c_...	RTC I2C peripheral interface.
TOUCH...	Analog function for capacitive touch sensing.
XTAL_32K_P	32 kHz external clock input/output connected to ESP32-S3's oscillator. P/N means differential clock positive/negative.
XTAL_32K_N	
ADC1_CH...	Analog to digital conversion channel for ADC1 or ADC2.
ADC2_CH...	
USB_D-	USB OTG and USB Serial/JTAG function. USB signal is a differential signal transmitted over a pair of D+ and D- wires.
USB_D+	

**Table 2-4. RTC and Analog Functions**

Pin No.	RTC / Analog IO Name	RTC Function				Analog Function	
		0	1	2	3	0	1
5	<b>RTC_GPIO0</b>	RTC_GPIO0			sar_i2c_scl_0		
6	RTC_GPIO1	RTC_GPIO1			sar_i2c_sda_0	TOUCH1	ADC1_CH0
7	RTC_GPIO2	RTC_GPIO2			sar_i2c_scl_1	TOUCH2	ADC1_CH1
8	<b>RTC_GPIO3</b>	RTC_GPIO3			sar_i2c_sda_1	TOUCH3	ADC1_CH2
9	RTC_GPIO4	RTC_GPIO4				TOUCH4	ADC1_CH3
10	RTC_GPIO5	RTC_GPIO5				TOUCH5	ADC1_CH4
11	RTC_GPIO6	RTC_GPIO6				TOUCH6	ADC1_CH5
12	RTC_GPIO7	RTC_GPIO7				TOUCH7	ADC1_CH6
13	RTC_GPIO8	RTC_GPIO8				TOUCH8	ADC1_CH7
14	RTC_GPIO9	RTC_GPIO9				TOUCH9	ADC1_CH8
15	RTC_GPIO10	RTC_GPIO10				TOUCH10	ADC1_CH9
16	RTC_GPIO11	RTC_GPIO11				TOUCH11	<b>ADC2_CH0</b>
17	RTC_GPIO12	RTC_GPIO12				TOUCH12	<b>ADC2_CH1</b>
18	RTC_GPIO13	RTC_GPIO13				TOUCH13	<b>ADC2_CH2</b>
19	RTC_GPIO14	RTC_GPIO14				TOUCH14	<b>ADC2_CH3</b>
21	RTC_GPIO15	RTC_GPIO15				XTAL_32K_P	<b>ADC2_CH4</b>
22	RTC_GPIO16	RTC_GPIO16				XTAL_32K_N	<b>ADC2_CH5</b>
23	RTC_GPIO17	RTC_GPIO17					<b>ADC2_CH6</b>
24	RTC_GPIO18	RTC_GPIO18					<b>ADC2_CH7</b>
25	RTC_GPIO19	RTC_GPIO19				<b>USB_D-</b>	<b>ADC2_CH8</b>
26	RTC_GPIO20	RTC_GPIO20				<b>USB_D+</b>	<b>ADC2_CH9</b>
27	RTC_GPIO21	RTC_GPIO21					

### 2.3.3 Restrictions for GPIOs and RTC\_GPIOs

All IO pins of the ESP32-S3 have GPIO and some have RTC\_GPIO pin functions. However, the IO pins are multiplexed and have other important pin functions. This should be taken into account while certain pins are chosen for general purpose input output.

In Table 2-3 *IO MUX and GPIO Pin Functions* and Table 2-4 *RTC and Analog Pin Functions* some pin functions are highlighted. The non-highlighted GPIO or RTC\_GPIO pins are recommended for use first. If more pins are needed, the highlighted GPIOs or RTC\_GPIOs should be chosen carefully to avoid conflicts with important pin functions.

The highlighted IO pins have the following important pin functions:

- **GPIO** – allocated for communication with in-package flash/PSRAM and NOT recommended for other uses. For details, see Section 2.7 *Pin Mapping Between Chip and Flash/PSRAM*.
- **GPIO** – no restrictions, unless the chip is connected to flash/PSRAM using Octal SPI mode. For details, see Section 2.7 *Pin Mapping Between Chip and Flash/PSRAM*.
- **GPIO** – have one of the following important functions:
  - **Strapping pins** – need to be at certain logic levels at startup. See Section 2.6 *Strapping Pins*.
  - **USB\_D+/-** – by default, connected to the USB Serial/JTAG Controller. To function as GPIOs, these pins need to be reconfigured (see [ESP32-S3 Technical Reference Manual](#) > Chapter *IO MUX and GPIO Matrix* for details).
  - **JTAG interface** – often used for debugging. See Table 2-3 *IO MUX and GPIO Pin Functions*, note 5a. To free these pins up, the pin functions USB\_D+/- of the USB Serial/JTAG Controller can be used instead. See also Section 2.6.4 *JTAG Signal Source Control*.
  - **UART interface** – often used for debugging. See Table 2-3 *IO MUX and GPIO Pin Functions*, note 5b.
  - **ADC2** – no restrictions, unless there is an on-going **Wi-Fi** connection. ADC2\_CH... analog functions (see Table 2-4 *RTC and Analog Pin Functions*) cannot be used with Wi-Fi simultaneously.

See also [Appendix A – ESP32-S3 Consolidated Pin Overview](#).

## 2.4 Analog Pins

Table 2-5. Analog Pins

Pin No.	Pin Name	Pin Type	Pin Function
1	LNA_IN	I/O	Low Noise Amplifier (RF LNA) input/output signals
4	CHIP_PU	I	High: on, enables the chip (Powered up). Low: off, the chip powers off (powered down). Note: Do not leave the CHIP_PU pin floating.
53	XTAL_N	—	External clock input/output connected to chip's crystal or oscillator. P/N means differential clock positive/negative.
54	XTAL_P	—	

## 2.5 Power Supply

### 2.5.1 Power Pins

The chip is powered via the power pins described in Table 2-6 *Power Pins*.

**Table 2-6. Power Pins**

Pin No.	Pin Name	Direction	Power Supply <sup>1,2</sup>	
			Power Domain / Other	IO Pins <sup>5</sup>
2	VDD3P3	Input	Analog power domain	
3	VDD3P3	Input	Analog power domain	
20	VDD3P3_RTC	Input	RTC and part of Digital power domains	RTC IO
29	VDD_SPI <sup>3,4</sup>	Input	In-package memory (backup power line)	
		Output	In-package and off-package flash/PSRAM	SPI IO
46	VDD3P3_CPU	Input	Digital power domain	Digital IO
55	VDDA	Input	Analog power domain	
56	VDDA	Input	Analog power domain	
57	GND	–	External ground connection	

<sup>1</sup> See in conjunction with Section 2.5.2 *Power Scheme*.

<sup>2</sup> For recommended and maximum voltage and current, see Section 4.1 *Absolute Maximum Ratings* and Section 4.2 *Recommended Power Supply Characteristics*.

<sup>3</sup> To configure VDD\_SPI as input or output, see [ESP32-S3 Technical Reference Manual](#) > Chapter *Low-power Management*.

<sup>4</sup> To configure output voltage, see Section 2.6.2 *VDD\_SPI Voltage Control* and Section 4.3 *VDD\_SPI Output Characteristics*.

<sup>5</sup> RTC IO pins are those powered by VDD3P3\_RTC and so on, as shown in Figure 2-2 *ESP32-S3 Power Scheme*. See also Table 2-1 *Pin Overview* > Column *Pin Providing Power*.

### 2.5.2 Power Scheme

The power scheme is shown in Figure 2-2 *ESP32-S3 Power Scheme*.

The components on the chip are powered via voltage regulators.

**Table 2-7. Voltage Regulators**

Voltage Regulator	Output	Power Supply
Digital	1.1 V	Digital power domain
Low-power	1.1 V	RTC power domain
Flash	1.8 V	Can be configured to power in-package flash/PSRAM or off-package memory

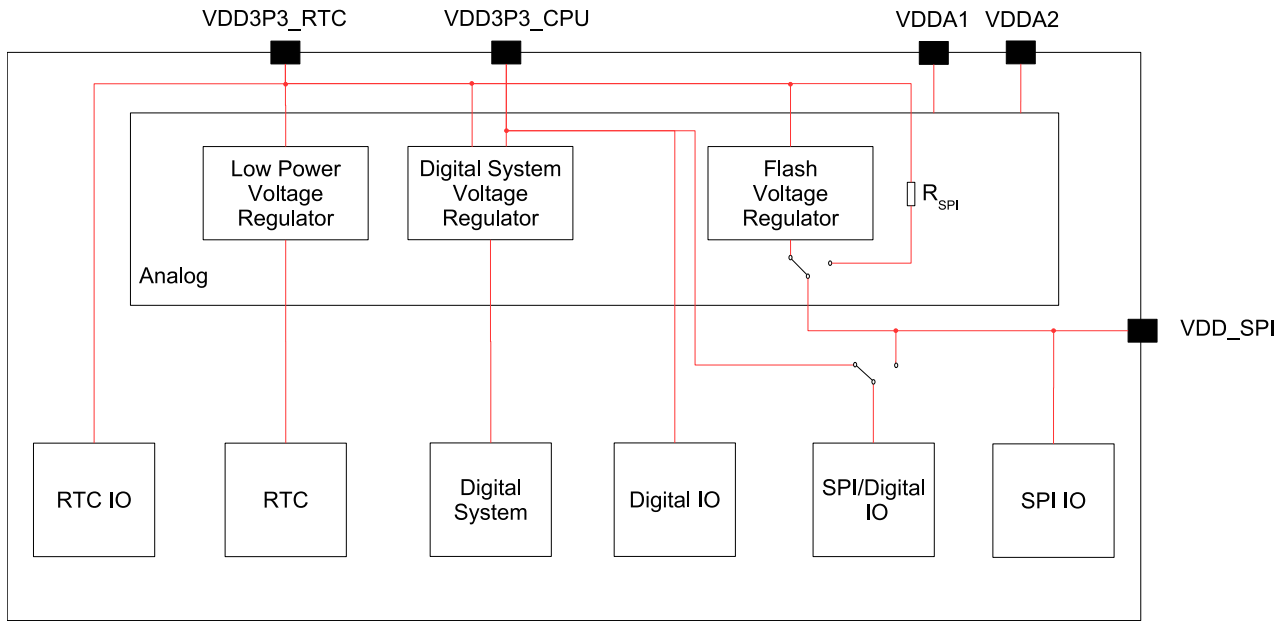

Figure 2-2. ESP32-S3 Power Scheme

### 2.5.3 Chip Power-up and Reset

Once the power is supplied to the chip, its power rails need a short time to stabilize. After that, CHIP\_PU – the pin used for power-up and reset – is pulled high to activate the chip. For information on CHIP\_PU as well as power-up and reset timing, see Figure 2-3 and Table 2-8.

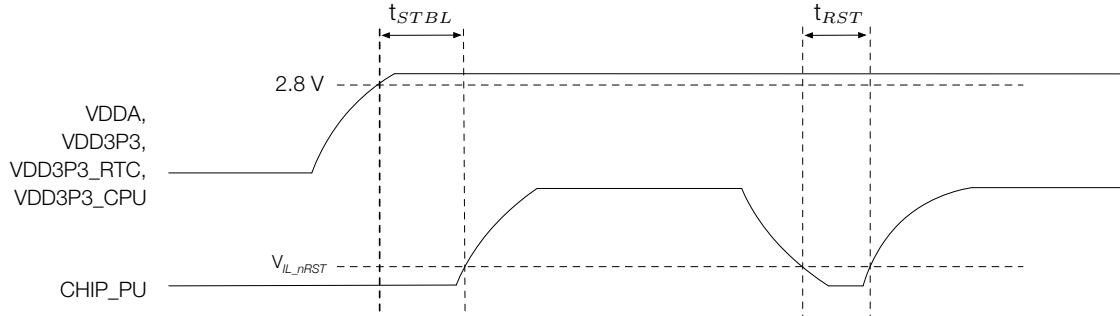

Figure 2-3. Visualization of Timing Parameters for Power-up and Reset

Table 2-8. Description of Timing Parameters for Power-up and Reset

Parameter	Description	Min (μs)
t <sub>STBL</sub>	Time reserved for the power rails of VDDA, VDD3P3, VDD3P3_RTC, and VDD3P3_CPU to stabilize before the CHIP_PU pin is pulled high to activate the chip	50
t <sub>RST</sub>	Time reserved for CHIP_PU to stay below V <sub>IL,nRST</sub> to reset the chip (see Table 4.4)	50

## 2.6 Strapping Pins

At each startup or reset, a chip requires some initial configuration parameters, such as in which boot mode to load the chip, voltage of flash memory, etc. These parameters are passed over via the strapping pins. After reset, the strapping pins operate as regular IO pins.

The parameters controlled by the given strapping pins at chip reset are as follows:

- **Chip boot mode** – GPIO0 and GPIO46
- **VDD\_SPI voltage** – GPIO45
- **ROM messages printing** – GPIO46
- **JTAG signal source** – GPIO3

GPIO0, GPIO45, and GPIO46 are connected to the chip's internal weak pull-up/pull-down resistors at chip reset. These resistors determine the default bit values of the strapping pins. Also, these resistors determine the bit values if the strapping pins are connected to an external high-impedance circuit.

**Table 2-9. Default Configuration of Strapping Pins**

Strapping Pin	Default Configuration	Bit Value
GPIO0	Pull-up	1
GPIO3	Floating	–
GPIO45	Pull-down	0
GPIO46	Pull-down	0

To change the bit values, the strapping pins should be connected to external pull-down/pull-up resistances. If the ESP32-S3 is used as a device by a host MCU, the strapping pin voltage levels can also be controlled by the host MCU.

All strapping pins have latches. At system reset, the latches sample the bit values of their respective strapping pins and store them until the chip is powered down or shut down. The states of latches cannot be changed in any other way. It makes the strapping pin values available during the entire chip operation, and the pins are freed up to be used as regular IO pins after reset.

Regarding the timing requirements for the strapping pins, there are such parameters as *setup time* and *hold time*. For more information, see Table 2-10 and Figure 2-4.

**Table 2-10. Description of Timing Parameters for the Strapping Pins**

Parameter	Description	Min (ms)
$t_{SU}$	<i>Setup time</i> is the time reserved for the power rails to stabilize before the CHIP_PU pin is pulled high to activate the chip.	0
$t_H$	<i>Hold time</i> is the time reserved for the chip to read the strapping pin values after CHIP_PU is already high and before these pins start operating as regular IO pins.	3

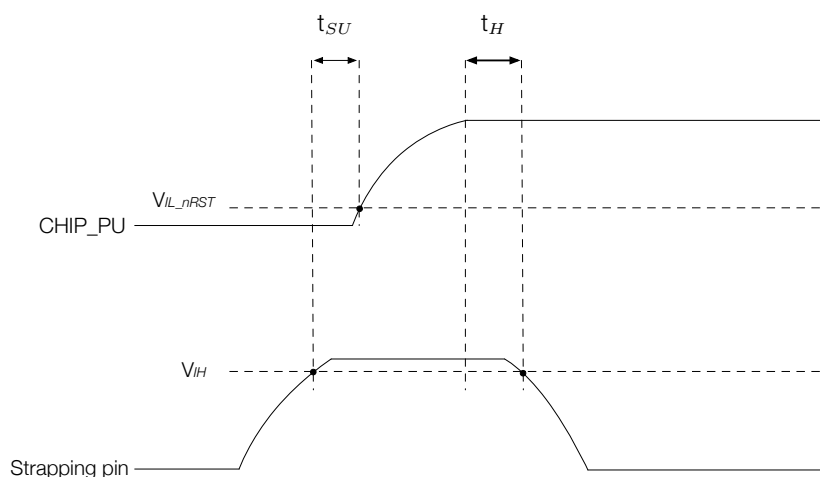

Figure 2-4. Visualization of Timing Parameters for the Strapping Pins

## 2.6.1 Chip Boot Mode Control

GPIO0 and GPIO46 control the boot mode after the reset is released. See Table 2-11 Chip Boot Mode Control.

Table 2-11. Chip Boot Mode Control

Boot Mode	GPIO0	GPIO46
Default Configuration	1 (Pull-up)	0 (Pull-down)
<b>SPI Boot (default)</b>	1	Any value
<b>Download Boot</b>	0	0
Invalid combination <sup>1</sup>	0	1

<sup>1</sup> This combination triggers unexpected behavior and should be avoided.

## 2.6.2 VDD\_SPI Voltage Control

The required VDD\_SPI voltage for the chips of the ESP32-S3 Series can be found in Table 1-1 Comparison.

Depending on the value of EFUSE\_VDD\_SPI\_FORCE, the voltage can be controlled in two ways.

Table 2-12. VDD\_SPI Voltage Control

EFUSE_VDD_SPI_FORCE	GPIO45	eFuse <sup>1</sup>	Voltage	VDD_SPI power source <sup>2</sup>
0	0	Ignored	3.3 V	VDD3P3_RTC via $R_{SPI}$
	1		1.8 V	Flash Voltage Regulator
1	Ignored	0	1.8 V	Flash Voltage Regulator
		1	3.3 V	VDD3P3_RTC via $R_{SPI}$

<sup>1</sup> eFuse: EFUSE\_VDD\_SPI\_TIEH

<sup>2</sup> See Section 2.5.2 Power Scheme



### 2.6.3 ROM Messages Printing Control

During boot process the messages by the ROM code can be printed to:

- (Default) UART and USB Serial/JTAG controller.
- USB Serial/JTAG controller.
- UART.

The ROM messages printing to UART or USB Serial/JTAG controller can be respectively disabled by configuring registers and eFuse. For detailed information, please refer to [ESP32-S3 Technical Reference Manual](#) > Chapter *Chip Boot Control*.

### 2.6.4 JTAG Signal Source Control

The strapping pin GPIO3 can be used to control the source of JTAG signals during the early boot process. This pin does not have any internal pull resistors and the strapping value must be controlled by the external circuit that cannot be in a high impedance state.

As Table 2-13 shows, GPIO3 is used in combination with EFUSE\_DIS\_PAD\_JTAG, EFUSE\_DIS\_USB\_JTAG, and EFUSE\_STRAP\_JTAG\_SEL.

**Table 2-13. JTAG Signal Source Control**

eFuse 1 <sup>a</sup>	eFuse 2 <sup>b</sup>	eFuse 3 <sup>c</sup>	GPIO3	JTAG Signal Source
0	0	0	Ignored	USB Serial/JTAG Controller
		1	0	JTAG pins MTDI, MTCK, MTMS, and MTDO
				1
0	1	Ignored	Ignored	JTAG pins MTDI, MTCK, MTMS, and MTDO
1	0	Ignored	Ignored	USB Serial/JTAG Controller
1	1	Ignored	Ignored	JTAG is disabled

<sup>a</sup> eFuse 1: EFUSE\_DIS\_PAD\_JTAG

<sup>b</sup> eFuse 2: EFUSE\_DIS\_USB\_JTAG

<sup>c</sup> eFuse 3: EFUSE\_STRAP\_JTAG\_SEL

## 2.7 Pin Mapping Between Chip and Flash/PSRAM

Table 2-14 lists the pin mapping between the chip and flash/PSRAM for all SPI modes.

For chip variants with in-package flash/PSRAM (see Table 1-1 Comparison), the pins allocated for communication with in-package flash/PSRAM can be identified depending on the SPI mode used.

For off-package flash/PSRAM, these are the recommended pin mappings.

For more information on SPI controllers, see also Section 3.5.2 Serial Peripheral Interface (SPI).

**Notice:**

It is not recommended to use the pins connected to flash/PSRAM for any other purposes.

**Table 2-14. Pin Mapping Between Chip and In-package Flash/ PSRAM**

Pin No.	Pin Name	Single SPI		Dual SPI		Quad SPI		Octal SPI	
		Flash	PSRAM	Flash	PSRAM	Flash	PSRAM	Flash	PSRAM
33	SPICLK	CLK	CLK	CLK	CLK	CLK	CLK	CLK	CLK
32	SPICS0 <sup>1</sup>	CS#		CS#		CS#		CS#	
28	SPICS1 <sup>2</sup>		CE#		CE#		CE#		CE#
35	SPID	DI	SI/SIO0	DI	SI/SIO0	DI	SI/SIO0	DQ0	DQ0
34	SPIQ	DO	SO/SIO1	DO	SO/SIO1	DO	SO/SIO1	DQ1	DQ1
31	SPIWP	WP#	SIO2	WP#	SIO2	WP#	SIO2	DQ2	DQ2
30	SPIHD	HOLD#	SIO3	HOLD#	SIO3	HOLD#	SIO3	DQ3	DQ3
38	GPIO33							DQ4	DQ4
39	GPIO34							DQ5	DQ5
40	GPIO35							DQ6	DQ6
41	GPIO36							DQ7	DQ7
42	GPIO37							DQS/DM	DQS/DM

<sup>1</sup> CS0 is for in-package flash

<sup>2</sup> CS1 is for in-package PSRAM

## 3 Functional Description

This chapter describes the functional modules of ESP32-S3.

### 3.1 CPU and Memory

#### 3.1.1 CPU

ESP32-S3 has a low-power Xtensa® dual-core 32-bit LX7 microprocessor with the following features:

- Five-stage pipeline that supports the clock frequency of up to 240 MHz
- 16-bit/24-bit instruction set providing high code density
- 32-bit customized instruction set and 128-bit data bus that provide high computing performance
- Support for single-precision floating-point unit (FPU)
- 32-bit multiplier and 32-bit divider
- Unbuffered GPIO instructions
- 32 interrupts at six levels
- Windowed ABI with 64 physical general registers
- Trace function with TRAX compressor, up to 16 KB trace memory
- JTAG for debugging

For information about the Xtensa® Instruction Set Architecture, please refer to [Xtensa® Instruction Set Architecture \(ISA\) Summary](#).

#### 3.1.2 Internal Memory

ESP32-S3's internal memory includes:

- **384 KB ROM:** for booting and core functions
- **512 KB on-chip SRAM:** for data and instructions, running at a configurable frequency of up to 240 MHz
- **RTC FAST memory:** 8 KB SRAM that supports read/write/instruction fetch by the main CPU (LX7 dual-core processor). It can retain data in Deep-sleep mode
- **RTC SLOW Memory:** 8 KB SRAM that supports read/write/instruction fetch by the main CPU (LX7 dual-core processor) or coprocessors. It can retain data in Deep-sleep mode
- **4 Kbit eFuse:** 1792 bits are reserved for user data, such as encryption key and device ID
- **In-package flash and PSRAM:** See details in Table [1-1 Comparison](#)

#### 3.1.3 External Flash and RAM

ESP32-S3 supports SPI, Dual SPI, Quad SPI, Octal SPI, QPI and OPI interfaces that allow connection to multiple external flash and RAM.

The external flash and RAM can be mapped into the CPU instruction memory space and read-only data memory space. The external RAM can also be mapped into the CPU data memory space. ESP32-S3 supports up to 1

GB of external flash and RAM, and hardware encryption/decryption based on XTS-AES to protect users' programs and data in flash and external RAM.

Through high-speed caches, ESP32-S3 can support at a time up to:

- External flash or RAM mapped into 32 MB instruction space as individual blocks of 64 KB
- External RAM mapped into 32 MB data space as individual blocks of 64 KB. 8-bit, 16-bit, 32-bit, and 128-bit reads and writes are supported. External flash can also be mapped into 32 MB data space as individual blocks of 64 KB, but only supporting 8-bit, 16-bit, 32-bit and 128-bit reads.

**Note:**  
After ESP32-S3 is initialized, firmware can customize the mapping of external RAM or flash into the CPU address space.

### 3.1.4 Address Mapping Structure

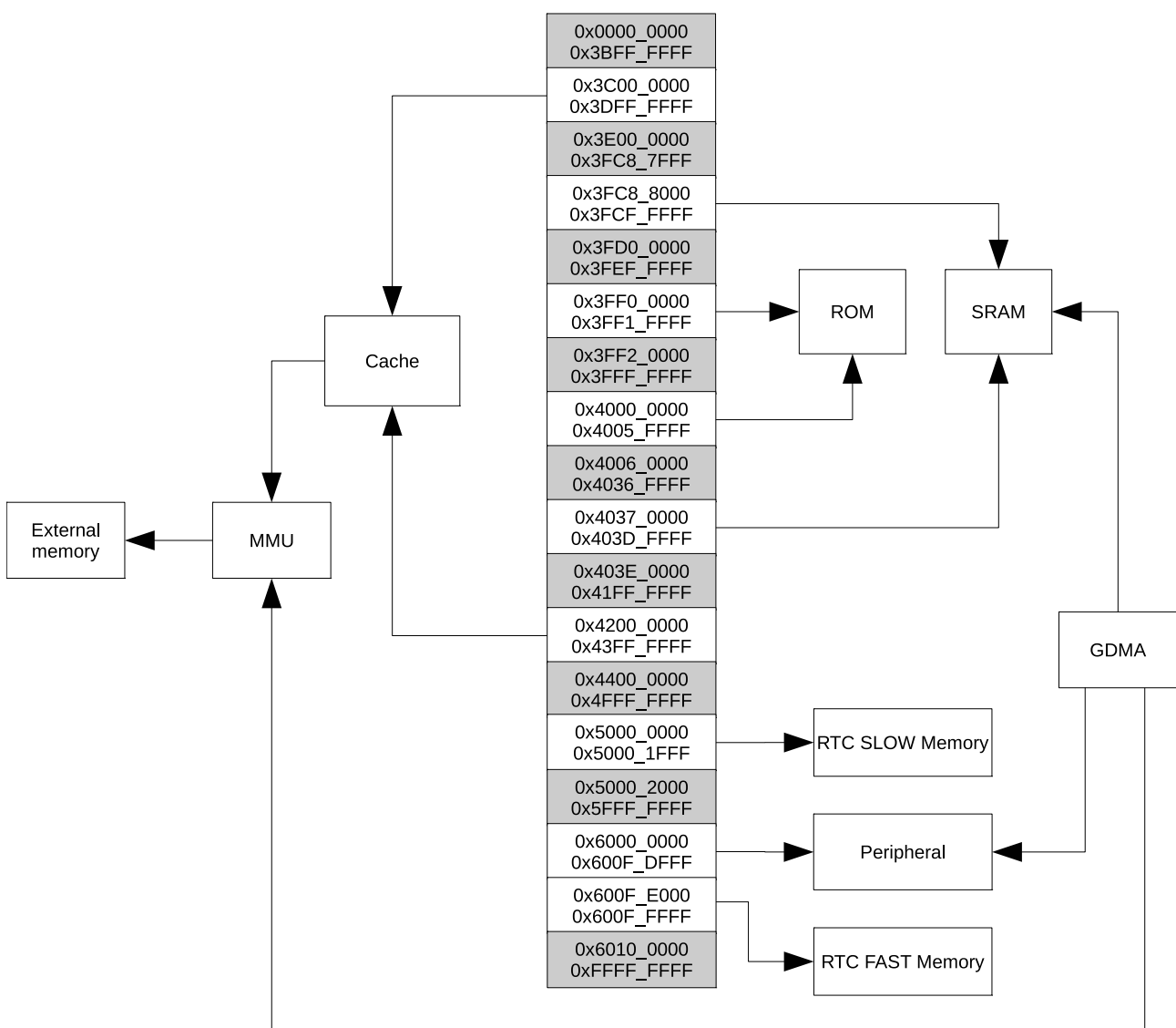

Figure 3-1. Address Mapping Structure

**Note:**

The memory space with gray background is not available to users.

### 3.1.5 Cache

ESP32-S3 has an instruction cache and a data cache shared by the two CPU cores. Each cache can be partitioned into multiple banks and has the following features:

- Instruction cache: 16 KB (one bank) or 32 KB (two banks)  
Data cache: 32 KB (one bank) or 64 KB (two banks)
- Instruction cache: four-way or eight-way set associative  
Data cache: four-way set associative
- Block size of 16 bytes or 32 bytes for both instruction cache and data cache
- Pre-load function
- Lock function
- Critical word first and early restart

### 3.1.6 eFuse Controller

ESP32-S3 contains a 4-Kbit eFuse to store parameters, which are burned and read by an eFuse Controller. The eFuse Controller has the following features:

- 4 Kbits in total, with 1792 bits reserved for users, e.g., encryption key and device ID
- One-time programmable storage
- Configurable write protection
- Configurable read protection
- Various hardware encoding schemes to protect against data corruption

For details, see [ESP32-S3 Technical Reference Manual](#) > Chapter *eFuse Controller*.

### 3.1.7 Processor Instruction Extensions

The ESP32-S3 contains a series of new extended instruction set in order to improve the operation efficiency of specific AI and DSP (Digital Signal Processing) algorithms. The Processor Instruction Extensions (PIE) has the following features:

- 128-bit new general-purpose registers
- 128-bit vector operations, e.g., complex multiplication, addition, subtraction, multiplication, shifting, comparison, etc
- Data handling instructions and load/store operation instructions combined
- Non-aligned 128-bit vector data
- Saturation operation

## 3.2 RTC and Low-Power Management

### 3.2.1 Power Management Unit (PMU)

The ESP32-S3 has an advanced Power Management Unit (PMU). It can be flexibly configured to power up different power domains of the chip to achieve the best balance between chip performance, power consumption, and wakeup latency.

The integrated Ultra-Low-Power (ULP) coprocessors allow the ESP32-S3 to operate in Deep-sleep mode with most of the power domains turned off, thus achieving extremely low-power consumption.

Configuring the PMU is a complex procedure. To simplify power management for typical scenarios, there are the following **predefined power modes** that power up different combinations of power domains:

- **Active mode** – The CPU, RF circuits, and all peripherals are on. The chip can process data, receive, transmit, and listen.
- **Modem-sleep mode** – The CPU is operational, and the clock speed can be reduced. The wireless connections can be configured to remain active as RF circuits are periodically switched on when required.
- **Light-sleep mode** – The CPU and part of peripheral are powered down. The RTC peripherals, as well as the ULP coprocessor can be woken up periodically by the timer. The chip can be woken up via all wake up mechanisms: MAC, host, RTC timer, or external interrupts. Wireless connections can remain active. Some groups of peripherals can be optionally shut down.
- **Deep-sleep mode** – Only the ULP coprocessor, RTC memory, and RTC peripherals are powered up. Wireless connection data is stored in RTC memory.

For power consumption in different power modes, see Section [4.6 Current Consumption](#).

Figure [3-2 Components and Power Domains](#) and the following Table [3-1](#) show the distribution of chip components between [power domains](#) and [power subdomains](#).

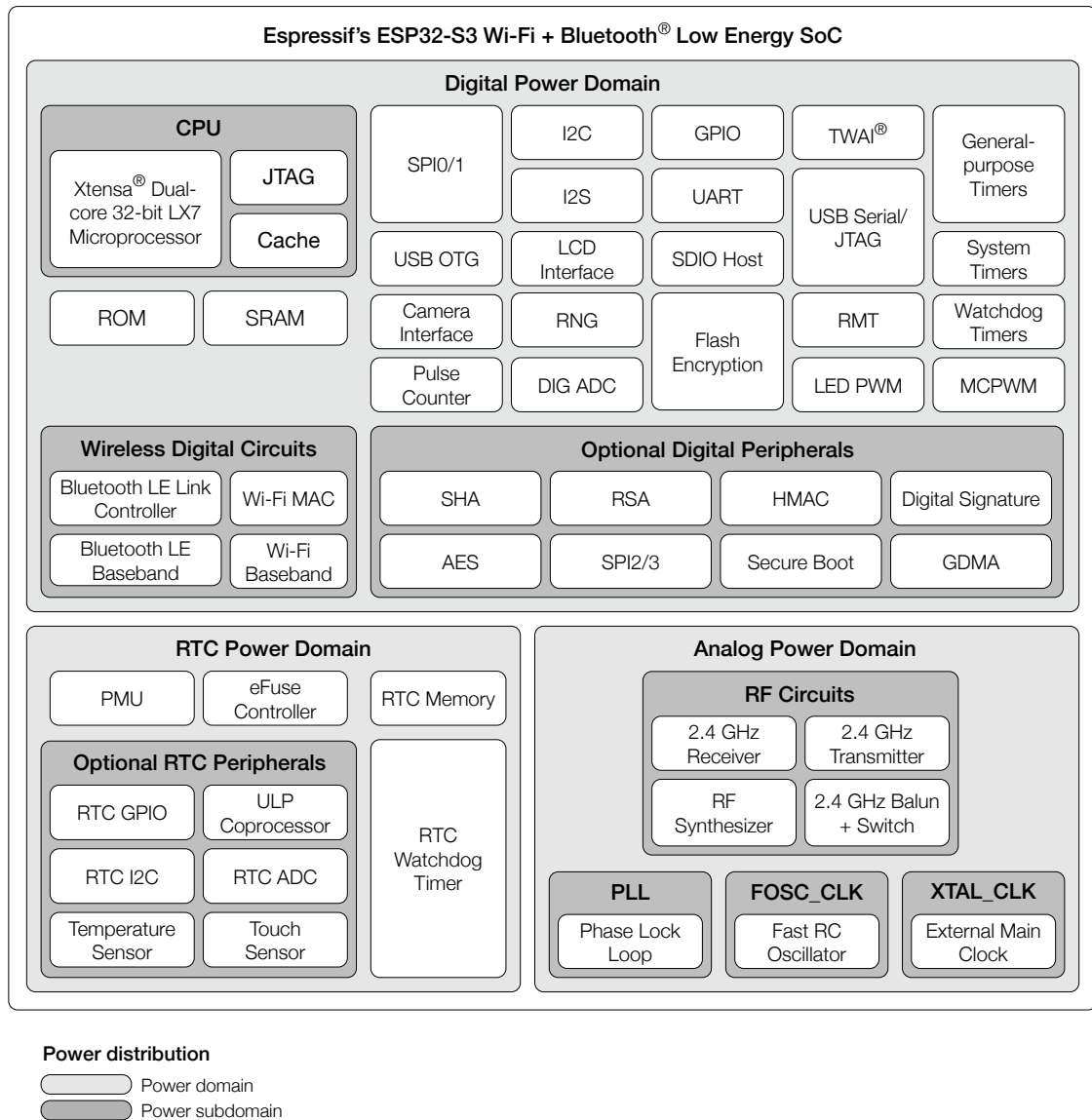

Figure 3-2. Components and Power Domains

Table 3-1. Components and Power Domains

Power Domain / Power Mode	RTC		Digital				Analog				
		Optional RTC Periph		CPU	Optional Digital Periph	Wireless Digital Circuits		FOSC_CLK	XTAL_CLK	PLL	RF Circuits
Active	ON	ON	ON	ON	ON	ON	ON	ON	ON	ON	ON
Modem-sleep	ON	ON	ON	ON	ON	ON <sup>1</sup>	ON	ON	ON	ON	OFF <sup>2</sup>
Light-sleep	ON	ON	ON	OFF <sup>1</sup>	ON	OFF <sup>1</sup>	ON	OFF	OFF	OFF	OFF <sup>2</sup>
Deep-sleep	ON	ON	OFF	OFF	OFF	OFF	ON	OFF	OFF	OFF	OFF

<sup>1</sup> Configurable, see [ESP32-S3 Technical Reference Manual](#).

<sup>2</sup> If Wireless Digital Circuits are on, RF circuits are periodically switched on when required by internal operation to keep active wireless connections running.

## 3.2.2 Ultra-Low-Power Coprocessor

The ULP coprocessor is designed as a simplified, low-power replacement of CPU in sleep modes. It can be also used to supplement the functions of the CPU in normal working mode. The ULP coprocessor and RTC memory remain powered up during the Deep-sleep mode. Hence, the developer can store a program for the ULP coprocessor in the RTC slow memory to access RTC GPIO, RTC peripheral devices, RTC timers and internal sensors in Deep-sleep mode.

ESP32-S3 has two ULP coprocessors, one based on RISC-V instruction set architecture (ULP-RISC-V) and the other on finite state machine (ULP-FSM). The clock of the coprocessors is the internal fast RC oscillator.

### ULP-RISC-V has the following features:

- Support for [RV32IMC](#) instruction set
- Thirty-two 32-bit general-purpose registers
- 32-bit multiplier and divider
- Support for interrupts
- Booted by the CPU, its dedicated timer, or RTC GPIO

### ULP-FSM has the following features:

- Support for common instructions including arithmetic, jump, and program control instructions
- Support for on-board sensor measurement instructions
- Booted by the CPU, its dedicated timer, or RTC GPIO

Note that these two coprocessors cannot work simultaneously.

## 3.3 Analog Peripherals

### 3.3.1 Analog-to-Digital Converter (ADC)

ESP32-S3 integrates two 12-bit SAR ADCs and supports measurements on 20 channels (analog-enabled pins). For power-saving purpose, the ULP coprocessors in ESP32-S3 can also be used to measure voltage in sleep modes. By using threshold settings or other methods, we can awaken the CPU from sleep modes.

### 3.3.2 Temperature Sensor

The temperature sensor generates a voltage that varies with temperature. The voltage is internally converted via an ADC into a digital value.

The temperature sensor has a range of  $-20\text{ }^{\circ}\text{C}$  to  $110\text{ }^{\circ}\text{C}$ . It is designed primarily to sense the temperature changes inside the chip. The temperature value depends on factors such as microcontroller clock frequency or I/O load. Generally, the chip's internal temperature is higher than the ambient temperature.

### 3.3.3 Touch Sensor

ESP32-S3 has 14 capacitive-sensing GPIOs, which detect variations induced by touching or approaching the GPIOs with a finger or other objects. The low-noise nature of the design and the high sensitivity of the circuit allow relatively small pads to be used. Arrays of pads can also be used, so that a larger area or more points can



be detected. The touch sensing performance can be further enhanced by the waterproof design and digital filtering feature.

**Note:**

ESP32-S3 Touch Sensor has not passed the Conducted Susceptibility (CS) test for now, and thus has limited application scenarios.

## 3.4 System Components

### 3.4.1 Reset and Clock

ESP32-S3 provides four reset levels, namely CPU Reset, Core Reset, System Reset, and Chip Reset.

- Support four reset levels:
  - CPU Reset: only resets CPU $x$  core. CPU $x$  can be CPU0 or CPU1 here. Once such reset is released, programs will be executed from CPU $x$  reset vector. Each CPU core has its own reset logic. If CPU Reset is from CPU0, the [sensitive registers](#) will be reset, too.
  - Core Reset: resets the whole digital system except RTC, including CPU0, CPU1, peripherals, Wi-Fi, Bluetooth<sup>®</sup> LE (BLE), and digital GPIOs.
  - System Reset: resets the whole digital system, including RTC.
  - Chip Reset: resets the whole chip.
- Support software reset and hardware reset:
  - Software reset is triggered by CPU $x$  configuring its corresponding registers.
  - Hardware reset is directly triggered by the circuit.

For details, see [ESP32-S3 Technical Reference Manual](#) > Chapter *Reset and Clock*.

### 3.4.2 Interrupt Matrix

The interrupt matrix embedded in ESP32-S3 independently allocates peripheral interrupt sources to the two CPUs' peripheral interrupts, to timely inform CPU0 or CPU1 to process the interrupts once the interrupt signals are generated. The Interrupt Matrix has the following features:

- 99 peripheral interrupt sources as input
- Generate 26 peripheral interrupts to CPU0 and 26 peripheral interrupts to CPU1 as output. Note that the remaining six CPU0 interrupts and six CPU1 interrupts are internal interrupts.
- Disable CPU non-maskable interrupt (NMI) sources
- Query current interrupt status of peripheral interrupt sources

For details, see [ESP32-S3 Technical Reference Manual](#) > Chapter *Interrupt Matrix*.

### 3.4.3 Permission Control

In ESP32-S3, the Permission Control module is used to control access to the slaves (including internal memory, peripherals, external flash and RAM). The host can access its slave only if it has the right permission. In this way, data and instructions are protected from illegitimate read or write.

The ESP32-S3 CPU can run in both Secure World and Non-secure World where independent permission controls are adopted. The Permission Control module is able to identify which World the host is running and then proceed with its normal operations.

The Permission Control module has the following features:

- Manage access to internal memory by:
  - CPU
  - CPU trace module
  - GDMA
- Manage access to external flash and RAM by:
  - MMU
  - SPI1
  - GDMA
  - CPU through Cache
- Manage access to peripherals, supporting
  - independent permission control for each peripheral
  - monitoring non-aligned access
  - access control for customized address range
- Integrate permission lock register
  - All permission registers can be locked with the permission lock register. Once locked, the permission register and the lock register cannot be modified, unless the CPU is reset.
- Integrate permission monitor interrupt
  - In case of illegitimate access, the permission monitor interrupt will be triggered and the CPU will be informed to handle the interrupt.

#### 3.4.4 System Registers

ESP32-S3 system registers can be used to control the following peripheral blocks and core modules:

- System and memory
- Clock
- Software Interrupt
- Low-power management
- Peripheral clock gating and reset
- CPU Control

For details, see [ESP32-S3 Technical Reference Manual](#) > Chapter *System Registers*.

### 3.4.5 GDMA Controller

ESP32-S3 has a general-purpose DMA controller (GDMA) with five independent channels for transmitting and another five independent channels for receiving. These ten channels are shared by peripherals that have DMA feature, and support dynamic priority.

The DMA controller controls data transfer using linked lists. It allows peripheral-to-memory and memory-to-memory data transfer at a high speed. All channels can access internal and external RAM.

The ten peripherals on ESP32-S3 with DMA feature are SPI2, SPI3, UHCI0, I2S0, I2S1, LCD/CAM, AES, SHA, ADC, and RMT.

For details, see [ESP32-S3 Technical Reference Manual](#) > Chapter *GDMA Controller*.

### 3.4.6 CPU Clock

The CPU clock has three possible sources:

- External main crystal clock
- Internal fast RC oscillator (typically about 17.5 MHz, and adjustable)
- PLL clock

The application can select the clock source from the three clocks above. The selected clock source drives the CPU clock directly, or after division, depending on the application. Once the CPU is reset, the default clock source would be the external main crystal clock divided by 2.

**Note:**

ESP32-S3 is unable to operate without an external main crystal clock.

For details about clocks, see [ESP32-S3 Technical Reference Manual](#) > Chapter *Reset and Clock*.

### 3.4.7 RTC Clock

The RTC slow clock is used for RTC counter, RTC watchdog and low-power controller. It has three possible sources:

- External low-speed (32 kHz) crystal clock
- Internal slow RC oscillator (typically about 136 kHz, and adjustable)
- Internal fast RC oscillator divided clock (derived from the internal fast RC oscillator divided by 256)

The RTC fast clock is used for RTC peripherals and sensor controllers. It has two possible sources:

- External main crystal clock divided by 2
- Internal fast RC oscillator (typically about 17.5 MHz, and adjustable)

### 3.4.8 Clock Glitch Detection

The Clock Glitch Detection module on ESP32-S3 monitors input clock signals from XTAL\_CLK. If it detects a glitch with a width shorter than 3 ns, input clock signals from XTAL\_CLK are blocked.

For details, see [ESP32-S3 Technical Reference Manual](#) > Chapter *Clock Glitch Detection*.

## 3.5 Digital Peripherals

### 3.5.1 IO MUX and GPIO Matrix

#### GPIO Matrix Features

- A full-switching matrix between the peripheral input/output signals and the GPIO pins
- 175 digital peripheral input signals can be sourced from the input of any GPIO pins
- The output of any GPIO pins can be from any of the 184 digital peripheral output signals
- Supports signal synchronization for peripheral inputs based on APB clock bus
- Provides input signal filter
- Supports sigma delta modulated output
- Supports GPIO simple input and output

#### IO MUX Features

- Provides one configuration register `IO_MUX_GPIO $n$ _REG` for each GPIO pin. The pin can be configured to
  - perform GPIO function routed by GPIO matrix.
  - or perform direct connection bypassing GPIO matrix.
- Supports some high-speed digital signals (SPI, JTAG, UART) bypassing GPIO matrix for better high-frequency digital performance. In this case, IO MUX is used to connect these pins directly to peripherals.

#### RTC IO MUX Features

- Controls low power feature of 22 RTC GPIO pins.
- Controls analog functions of 22 RTC GPIO pins.
- Redirects 22 RTC input/output signals to RTC system.

For details, see [ESP32-S3 Technical Reference Manual](#) > Chapter *IO MUX and GPIO Matrix*.

### 3.5.2 Serial Peripheral Interface (SPI)

ESP32-S3 has the following SPI interfaces:

- **SPI0** used by ESP32-S3's cache and Crypto DMA (EDMA) to access in-package or off-package flash/PSRAM
- **SPI1** used by the CPU to access in-package or off-package flash/PSRAM
- **SPI2** is a general purpose SPI controller with its own DMA channel
- **SPI3** is a general purpose SPI controller with access to a DMA channel shared between several peripherals

#### Features of SPI0 and SPI1

- Supports Single SPI, Dual SPI, Quad SPI (QPI), and Octal SPI (OPI) modes
- Octal SPI mode supports single data rate (SDR) and double data rate (DDR)

- Configurable clock frequency with a maximum of 120 MHz for Octal SPI SDR/DDR modes
- Data transmission is in bytes

### Features of SPI2

- Supports operation as a master or slave
- Has its own DMA channel
- Supports Single SPI, Dual SPI, Quad SPI (QPI), and Octal SPI (OPI) modes
- Configurable clock polarity (CPOL) and phase (CPHA)
- Configurable clock frequency
- Data transmission is in bytes
- Configurable read and write data bit order: most-significant bit (MSB) first, or least-significant bit (LSB) first
- As a master
  - Supports 2-line full-duplex communication with clock frequency up to 80 MHz
  - Full-duplex Octal SPI mode supports single data rate (SDR) only
  - Supports 1-, 2-, 4-, 8-line half-duplex communication with clock frequency up to 80 MHz
  - Half-duplex Octal SPI mode supports both single data rate (up to 80 MHz) and double data rate (up to 40 MHz)
  - Support Moto6800/I8080/Parallel RGB interface 8-bit LCD driver
  - Provides six SPI\_CS pins for connection with six independent SPI slaves
  - Configurable CS setup time and hold time
- As a slave
  - Supports 2-line full-duplex communication with clock frequency up to 60 MHz
  - Supports 1-, 2-, 4-line half-duplex communication with clock frequency up to 60 MHz
  - Full-duplex and half-duplex Octal SPI mode supports single data rate (SDR) only

### Features of SPI3

- Supports operation as a master or slave
- Shares a DMA channel with ADC and DAC peripherals
- Supports Single SPI, Dual SPI, Quad SPI (QPI), and Octal SPI (OPI) modes
- Octal SPI mode supports single data rate (SDR) only
- Configurable clock polarity (CPOL) and phase (CPHA)
- Configurable clock frequency
- Data transmission is in bytes
- Configurable read and write data bit order: most-significant bit (MSB) first, or least-significant bit (LSB) first

- As a master
  - Supports 2-line full-duplex communication with clock frequency up to 80 MHz
  - Supports 1-, 2-, 4-line half-duplex communication with clock frequency up to 80 MHz
  - Support 1-bit LCD driver
  - Provides three SPI\_CS pins for connection with three independent SPI slaves
  - Configurable CS setup time and hold time
- As a slave
  - Supports 2-line full-duplex communication with clock frequency up to 60 MHz
  - Supports 1-, 2-, 4-line half-duplex communication with clock frequency up to 60 MHz

## Pin Configuration

**Table 3-2. SPI Pin Configuration**

Interface	Suggested IO MUX Pins	Routing via GPIO Matrix
SPI0/1	See Table 2-3 IO MUX and GPIO Pin Functions, notes 5c, 5d	–
SPI2	See Table 2-3 IO MUX and GPIO Pin Functions, note 5e	Any IO pins
SPI3	–	Any IO pins

For details, see [ESP32-S3 Technical Reference Manual](#) > Chapter *SPI Controller*.

### 3.5.3 LCD Interface

ESP32-S3 supports 8-bit ~16-bit parallel RGB, I8080, and MOTO6800 interfaces. These interfaces operate at 40 MHz or lower, and support conversion among RGB565, YUV422, YUV420, and YUV411.

### 3.5.4 Camera Interface

ESP32-S3 supports an 8-bit ~16-bit DVP image sensor, with clock frequency of up to 40 MHz. The camera interface supports conversion among RGB565, YUV422, YUV420, and YUV411.

### 3.5.5 UART Controller

ESP32-S3 has three UART (Universal Asynchronous Receiver Transmitter) controllers, i.e., UART0, UART1, and UART2, which support IrDA and asynchronous communication (RS232 and RS485) at a speed of up to 5 Mbps. Each UART Controller has the following features:

- Three clock sources that can be divided
- Programmable baud rate
- 1024 x 8-bit RAM shared by TX FIFOs and RX FIFOs of the three UART controllers
- Full-duplex asynchronous communication
- Automatic baud rate detection of input signals
- Data bits ranging from 5 to 8

- Stop bits of 1, 1.5, 2 or 3 bits
- Parity bit
- Special character AT\_CMD detection
- RS485 protocol
- IrDA protocol
- High-speed data communication using GDMA
- UART as wake-up source
- Software and hardware flow control

For details, see [ESP32-S3 Technical Reference Manual](#) > Chapter *UART Controller*.

### 3.5.6 I2C Interface

ESP32-S3 has two I2C bus interfaces which are used for I2C master mode or slave mode, depending on the user's configuration. The I2C interfaces support:

- Standard mode (100 kbit/s)
- Fast mode (400 kbit/s)
- Up to 800 kbit/s (constrained by SCL and SDA pull-up strength)
- 7-bit and 10-bit addressing mode
- Double addressing mode (slave addressing and slave register addressing)

The hardware provides a command abstraction layer to simplify the usage of the I2C peripheral.

For details, see [ESP32-S3 Technical Reference Manual](#) > Chapter *I2C Controller*.

### 3.5.7 I2S Interface

ESP32-S3 includes two standard I2S interfaces. They can operate in master mode or slave mode, in full-duplex mode or half-duplex communication mode, and can be configured to operate with an 8-bit, 16-bit, 24-bit, or 32-bit resolution as an input or output channel. BCK clock frequency, from 10 kHz up to 40 MHz, is supported.

The I2S interface has a dedicated DMA controller. It supports TDM PCM, TDM MSB alignment, TDM LSB alignment, TDM Phillips, and PDM interface.

### 3.5.8 Remote Control Peripheral

The RMT (Remote Control Peripheral) module is designed to send and receive infrared remote control signals. It has the following features:

- Four TX channels
- Four RX channels
- Support multiple channels (programmable) transmitting data simultaneously
- Eight channels share a 384 x 32-bit RAM

- Support modulation on TX pulses
- Support filtering and demodulation on RX pulses
- Wrap TX mode
- Wrap RX mode
- Continuous TX mode
- DMA access for TX mode on channel 3
- DMA access for RX mode on channel 7

For details, see [ESP32-S3 Technical Reference Manual](#) > Chapter *Remote Control Peripheral*.

### 3.5.9 Pulse Count Controller

The pulse count controller captures pulse and counts pulse edges through multiple modes. It has the following features:

- Four independent pulse counters (units) that count from 1 to 65535
- Each unit consists of two independent channels sharing one pulse counter
- All channels have input pulse signals (e.g. `sig_ch0_un`) with their corresponding control signals (e.g. `ctrl_ch0_un`)
- Independently filter glitches of input pulse signals (`sig_ch0_un` and `sig_ch1_un`) and control signals (`ctrl_ch0_un` and `ctrl_ch1_un`) on each unit
- Each channel has the following parameters:
  1. Selection between counting on positive or negative edges of the input pulse signal
  2. Configuration to Increment, Decrement, or Disable counter mode for control signal's high and low states

For details, see [ESP32-S3 Technical Reference Manual](#) > Chapter *Pulse Count Controller*.

### 3.5.10 LED PWM Controller

The LED PWM controller can generate independent digital waveforms on eight channels. The LED PWM controller has the following features:

- Can generate a digital waveform with configurable periods and duty cycle. The duty cycle resolution can be up to 14 bits within a 1 ms period.
- Has multiple clock sources, including APB clock and external main crystal clock.
- Can operate when the CPU is in Light-sleep mode.
- Supports gradual increase or decrease of duty cycle, which is useful for the LED RGB color-fading generator.

For details, see [ESP32-S3 Technical Reference Manual](#) > Chapter *LED PWM Controller*.



### 3.5.11 USB 2.0 OTG Full-Speed Interface

ESP32-S3 features a full-speed USB OTG interface along with an integrated transceiver. The USB OTG interface complies with the USB 2.0 specification. It has the following features:

#### General Features

- FS and LS data rates
- HNP and SRP as A-device or B-device
- Dynamic FIFO (DFIFO) sizing
- Multiple modes of memory access
  - Scatter/Gather DMA mode
  - Buffer DMA mode
  - Slave mode
- Can choose integrated transceiver or external transceiver
- Utilizing integrated transceiver with USB Serial/JTAG by time-division multiplexing when only integrated transceiver is used
- Support USB OTG using one of the transceivers while USB Serial/JTAG using the other one when both integrated transceiver or external transceiver are used

#### Device Mode Features

- Endpoint number 0 always present (bi-directional, consisting of EP0 IN and EP0 OUT)
- Six additional endpoints (endpoint numbers 1 to 6), configurable as IN or OUT
- Maximum of five IN endpoints concurrently active at any time (including EP0 IN)
- All OUT endpoints share a single RX FIFO
- Each IN endpoint has a dedicated TX FIFO

#### Host Mode Features

- 8 channels (pipes)
  - A control pipe consists of two channels (IN and OUT), as IN and OUT transactions must be handled separately. Only Control transfer type is supported.
  - Each of the other seven channels is dynamically configurable to be IN or OUT, and supports Bulk, Isochronous, and Interrupt transfer types.
- All channels share an RX FIFO, non-periodic TX FIFO, and periodic TX FIFO. The size of each FIFO is configurable.

For details, see [ESP32-S3 Technical Reference Manual](#) > Chapter *USB On-The-Go*.

### 3.5.12 USB Serial/JTAG Controller

ESP32-S3 integrates a USB Serial/JTAG controller that supports the following features:

- USB Full-speed device.

- Can be configured to either use internal USB PHY of ESP32-S3 or external PHY via GPIO matrix.
- Fixed function device, hardwired for CDC-ACM (Communication Device Class - Abstract Control Model) and JTAG adapter functionality.
- 2 OUT Endpoints, 3 IN Endpoints in addition to Control Endpoint 0; Up to 64-byte data payload size.
- Internal PHY, so no or very few external components needed to connect to a host computer.
- CDC-ACM adherent serial port emulation is plug-and-play on most modern OSes.
- JTAG interface allows fast communication with CPU debug core using a compact representation of JTAG instructions.
- CDC-ACM supports host controllable chip reset and entry into download mode.

For details, see [ESP32-S3 Technical Reference Manual](#) > Chapter *USB Serial/JTAG Controller*.

### 3.5.13 Motor Control PWM (MCPWM)

ESP32-S3 integrates two MCPWM that can be used to drive digital motors and smart light. Each MCPWM peripheral has one clock divider (prescaler), three PWM timers, three PWM operators, and a capture module. PWM timers are used for generating timing references. The PWM operators generate desired waveform based on the timing references. Any PWM operator can be configured to use the timing references of any PWM timers. Different PWM operators can use the same PWM timer's timing references to produce related PWM signals. PWM operators can also use different PWM timers' values to produce the PWM signals that work alone. Different PWM timers can also be synchronized together.

For details, see [ESP32-S3 Technical Reference Manual](#) > Chapter *Motor Control PWM*.

### 3.5.14 SD/MMC Host Controller

ESP32-S3 has an SD/MMC Host Controller with the following features:

- Secure Digital (SD) memory version 3.0 and version 3.01
- Secure Digital I/O (SDIO) version 3.0
- Consumer Electronics Advanced Transport Architecture (CE-ATA) version 1.1
- Multimedia Cards (MMC version 4.41, eMMC version 4.5 and version 4.51)
- Up to 80 MHz clock output
- Three data bus modes:
  - 1-bit
  - 4-bit (supports two SD/SDIO/MMC 4.41 cards, and one SD card operating at 1.8 V in 4-bit mode)
  - 8-bit

For details, see [ESP32-S3 Technical Reference Manual](#) > Chapter *SD/MMC Host Controller*.

### 3.5.15 TWAI® Controller

The Two-wire Automotive Interface (TWAI) is a multi-master, multi-cast communication protocol with error detection and signaling as well as inbuilt message priorities and arbitration. The TWAI controller in ESP32-S3 supports the following features:

- Compatible with ISO 11898-1 protocol (CAN Specification 2.0)
- Standard frame format (11-bit ID) and extended frame format (29-bit ID)
- Bit rates from 1 Kbit/s to 1 Mbit/s
- Multiple modes of operation:
  - Normal
  - Listen Only
  - Self-Test (no acknowledgment required)
- 64-byte receive FIFO
- Acceptance filter (single and dual filter modes)
- Error detection and handling:
  - Error counters
  - Configurable error interrupt threshold
  - Error code capture
  - Arbitration lost capture

For details, see [ESP32-S3 Technical Reference Manual](#) > Chapter *Two-wire Automotive Interface*.

## 3.6 Radio and Wi-Fi

The ESP32-S3 radio consists of the following blocks:

- 2.4 GHz receiver
- 2.4 GHz transmitter
- Bias and regulators
- Balun and transmit-receive switch
- Clock generator

### 3.6.1 2.4 GHz Receiver

The 2.4 GHz receiver demodulates the 2.4 GHz RF signal to quadrature baseband signals and converts them to the digital domain with two high-resolution, high-speed ADCs. To adapt to varying signal channel conditions, ESP32-S3 integrates RF filters, Automatic Gain Control (AGC), DC offset cancelation circuits, and baseband filters.

### 3.6.2 2.4 GHz Transmitter

The 2.4 GHz transmitter modulates the quadrature baseband signals to the 2.4 GHz RF signal, and drives the antenna with a high-powered CMOS power amplifier. The use of digital calibration further improves the linearity of the power amplifier.

To compensate for receiver imperfections, additional calibration methods are built into the chip, including:

- Carrier leakage compensation

- I/Q amplitude/phase matching
- Baseband nonlinearities suppression
- RF nonlinearities suppression
- Antenna matching

These built-in calibration routines reduce the cost and time to the market for your product, and eliminate the need for specialized testing equipment.

### 3.6.3 Clock Generator

The clock generator produces quadrature clock signals of 2.4 GHz for both the receiver and the transmitter. All components of the clock generator are integrated into the chip, including inductors, varactors, filters, regulators, and dividers.

The clock generator has built-in calibration and self-test circuits. Quadrature clock phases and phase noise are optimized on chip with patented calibration algorithms which ensure the best performance of the receiver and the transmitter.

### 3.6.4 Wi-Fi Radio and Baseband

The ESP32-S3 Wi-Fi radio and baseband support the following features:

- 802.11b/g/n
- 802.11n MCS0-7 that supports 20 MHz and 40 MHz bandwidth
- 802.11n MCS32
- 802.11n 0.4  $\mu$ s guard-interval
- Data rate up to 150 Mbps
- RX STBC (single spatial stream)
- Adjustable transmitting power
- Antenna diversity:  
ESP32-S3 supports antenna diversity with an external RF switch. This switch is controlled by one or more GPIOs, and used to select the best antenna to minimize the effects of channel imperfections.

### 3.6.5 Wi-Fi MAC

ESP32-S3 implements the full 802.11 b/g/n Wi-Fi MAC protocol. It supports the Basic Service Set (BSS) STA and SoftAP operations under the Distributed Control Function (DCF). Power management is handled automatically with minimal host interaction to minimize the active duty period.

The ESP32-S3 Wi-Fi MAC applies the following low-level protocol functions automatically:

- 4  $\times$  virtual Wi-Fi interfaces
- Simultaneous Infrastructure BSS Station mode, SoftAP mode, and Station + SoftAP mode
- RTS protection, CTS protection, Immediate Block ACK
- Fragmentation and defragmentation

- TX/RX A-MPDU, TX/RX A-MSDU
- TXOP
- WMM
- GCMP, CCMP, TKIP, WAPI, WEP, and BIP
- Automatic beacon monitoring (hardware TSF)
- 802.11mc FTM

#### 3.6.6 Networking Features

Users are provided with libraries for TCP/IP networking, ESP-WIFI-MESH networking, and other networking protocols over Wi-Fi. TLS 1.2 support is also provided.

### 3.7 Bluetooth LE

ESP32-S3 includes a Bluetooth Low Energy subsystem that integrates a hardware link layer controller, an RF/modem block and a feature-rich software protocol stack. It supports the core features of Bluetooth 5 and Bluetooth mesh.

#### 3.7.1 Bluetooth LE Radio and PHY

Bluetooth Low Energy radio and PHY in ESP32-S3 support:

- 1 Mbps PHY
- 2 Mbps PHY for high transmission speed and high data throughput
- Coded PHY for high RX sensitivity and long range (125 Kbps and 500 Kbps)
- Class 1 transmit power without external PA
- HW Listen before talk (LBT)

#### 3.7.2 Bluetooth LE Link Layer Controller

Bluetooth Low Energy Link Layer Controller in ESP32-S3 supports:

- LE advertising extensions, to enhance broadcasting capacity and broadcast more intelligent data
- Multiple advertisement sets
- Simultaneous advertising and scanning
- Multiple connections in simultaneous central and peripheral roles
- Adaptive frequency hopping and channel assessment
- LE channel selection algorithm #2
- Connection parameter update
- High duty cycle non-connectable advertising
- LE privacy 1.2
- LE data packet length extension

- Link layer extended scanner filter policies
- Low duty cycle directed advertising
- Link layer encryption
- LE Ping

## 3.8 Timers and Watchdogs

### 3.8.1 General Purpose Timers

ESP32-S3 is embedded with four 54-bit general-purpose timers, which are based on 16-bit prescalers and 54-bit auto-reload-capable up/down-timers.

The timers' features are summarized as follows:

- A 16-bit clock prescaler, from 2 to 65536
- A 54-bit time-base counter programmable to be incrementing or decrementing
- Able to read real-time value of the time-base counter
- Halting and resuming the time-base counter
- Programmable alarm generation
- Timer value reload (Auto-reload at alarm or software-controlled instant reload)
- Level interrupt generation

For details, see [ESP32-S3 Technical Reference Manual](#) > Chapter *Timer Group*.

### 3.8.2 System Timer

ESP32-S3 integrates a 52-bit system timer, which has two 52-bit counters and three comparators. The system timer has the following features:

- Counters with a clock frequency of 16 MHz
- Three types of independent interrupts generated according to alarm value
- Two alarm modes: target mode and period mode
- 52-bit target alarm value and 26-bit periodic alarm value
- Read sleep time from RTC timer when the chip is awoken from Deep-sleep or Light-sleep mode
- Counters can be stalled if the CPU is stalled or in OCD mode

For details, see [ESP32-S3 Technical Reference Manual](#) > Chapter *System Timer*.

### 3.8.3 Watchdog Timers

The ESP32-S3 contains three watchdog timers: one in each of the two timer groups (called Main System Watchdog Timers, or MWDT) and one in the RTC Module (called the RTC Watchdog Timer, or RWDT).

During the flash boot process, RWDT and the first MWDT are enabled automatically in order to detect and recover from booting errors.

Watchdog timers have the following features:

- Four stages, each with a programmable timeout value. Each stage can be configured, enabled and disabled separately
- Interrupt, CPU reset, or core reset for MWDT upon expiry of each stage; interrupt, CPU reset, core reset, or system reset for RWDT upon expiry of each stage
- 32-bit expiry counter
- Write protection, to prevent RWDT and MWDT configuration from being altered inadvertently
- Flash boot protection  
If the boot process from an SPI flash does not complete within a predetermined period of time, the watchdog will reboot the entire main system.

For details, see [ESP32-S3 Technical Reference Manual](#) > Chapter *Watchdog Timers*.

### 3.8.4 XTAL32K Watchdog Timers

#### Interrupt and Wake-Up

When the XTAL32K watchdog timer detects the oscillation failure of XTAL32K\_CLK, an oscillation failure interrupt RTC\_XTAL32K\_DEAD\_INT (for interrupt description, please refer to [ESP32-S3 Technical Reference Manual](#)) is generated. At this point, the CPU will be woken up if in Light-sleep mode or Deep-sleep mode.

#### BACKUP32K\_CLK

Once the XTAL32K watchdog timer detects the oscillation failure of XTAL32K\_CLK, it replaces XTAL32K\_CLK with BACKUP32K\_CLK (with a frequency of 32 kHz or so) derived from RTC\_CLK as RTC's SLOW\_CLK, so as to ensure proper functioning of the system.

For details, see [ESP32-S3 Technical Reference Manual](#) > Chapter *XTAL32K Watchdog Timers*.

## 3.9 Cryptography/Security Components

### 3.9.1 External Memory Encryption and Decryption

ESP32-S3 integrates an External Memory Encryption and Decryption module that complies with the XTS-AES standard. It supports the following features:

- General XTS\_AES algorithm, compliant with IEEE Std 1619-2007
- Software-based manual encryption
- High-speed auto encryption, without software's participation
- High-speed auto decryption, without software's participation
- Encryption and decryption functions jointly determined by registers configuration, eFuse parameters, and boot mode

For details, see [ESP32-S3 Technical Reference Manual](#) > Chapter *External Memory Encryption and Decryption*.

### 3.9.2 Secure Boot

Secure Boot feature uses a hardware root of trust to ensure only signed firmware (with RSA-PSS signature) can be booted.

### 3.9.3 HMAC Accelerator

The Hash-based Message Authentication Code (HMAC) module computes Message Authentication Codes (MACs) using Hash algorithm and keys as described in RFC 2104. The HMAC Accelerator in ESP32-S3 supports the following features:

- Standard HMAC-SHA-256 algorithm
- Hash result only accessible by configurable hardware peripheral (in downstream mode)
- Compatible to challenge-response authentication algorithm
- Generates required keys for the Digital Signature (DS) peripheral (in downstream mode)
- Re-enables soft-disabled JTAG (in downstream mode)

For details, see [ESP32-S3 Technical Reference Manual](#) > Chapter *HMAC Accelerator*.

### 3.9.4 Digital Signature

A Digital Signature is used to verify the authenticity and integrity of a message using a cryptographic algorithm. The Digital Signature (DS) in ESP32-S3 supports the following features:

- RSA Digital Signatures with key length up to 4096 bits
- Encrypted private key data, only decryptable by DS peripheral
- SHA-256 digest to protect private key data against tampering by an attacker

For details, see [ESP32-S3 Technical Reference Manual](#) > Chapter *Digital Signature*.

### 3.9.5 World Controller

The ESP32-S3 can divide the hardware and software resources into a Secure World and a Non-Secure World to prevent sabotage or access to device information. Switching between the two worlds is performed by the World Controller, which supports the following features:

- Control of the CPU switching between secure and non-secure worlds
- Control of 15 DMA peripherals switching between secure and non-secure worlds
- Record of CPU's world switching logs
- Shielding of the CPU's NMI interrupt

### 3.9.6 SHA Accelerator

ESP32-S3 integrates an SHA accelerator, which is a hardware device that speeds up SHA algorithm significantly. The SHA Accelerator supports the following features:

- All the hash algorithms introduced in [FIPS PUB 180-4 Spec](#).
  - SHA-1



- SHA-224
- SHA-256
- SHA-384
- SHA-512
- SHA-512/224
- SHA-512/256
- SHA-512/t
- Two working modes
  - Typical SHA
  - DMA-SHA
- interleaved function when working in Typical SHA working mode
- Interrupt function when working in DMA-SHA working mode

For details, see [ESP32-S3 Technical Reference Manual](#) > Chapter *SHA Accelerator*.

### 3.9.7 AES Accelerator

ESP32-S3 integrates an Advanced Encryption Standard (AES) Accelerator, which is a hardware device that speeds up AES Algorithm significantly. The AES Accelerator supports the following features:

- Typical AES working mode
  - AES-128/AES-256 encryption and decryption
- DMA-AES working mode
  - AES-128/AES-256 encryption and decryption
  - Block cipher mode
    - \* ECB (Electronic Codebook)
    - \* CBC (Cipher Block Chaining)
    - \* OFB (Output Feedback)
    - \* CTR (Counter)
    - \* CFB8 (8-bit Cipher Feedback)
    - \* CFB128 (128-bit Cipher Feedback)
  - Interrupt on completion of computation

For details, see [ESP32-S3 Technical Reference Manual](#) > Chapter *AES Accelerator*.

### 3.9.8 RSA Accelerator

The RSA Accelerator provides hardware support for high precision computation used in various RSA asymmetric cipher algorithms. The RSA Accelerator in ESP32-S3 supports the following features:

- Large-number modular exponentiation with two optional acceleration options

- Large-number modular multiplication
- Large-number multiplication
- Operands of different lengths
- Interrupt on completion of computation

For details, see [ESP32-S3 Technical Reference Manual](#) > Chapter *RSA Accelerator*.

### 3.9.9 Random Number Generator

The random number generator in ESP32-S3 generates true random numbers, which means random number generated from a physical process, rather than by means of an algorithm. No number generated within the specified range is more or less likely to appear than any other number.

For details, see [ESP32-S3 Technical Reference Manual](#) > Chapter *Random Number Generator*.

## 3.10 Peripheral Pin Configurations

**Table 3-3. Peripheral Pin Configurations**

Interface	Signal	Pin	Function
ADC	ADC1_CH0	GPIO1	Two 12-bit SAR ADCs
	ADC1_CH1	GPIO2	
	ADC1_CH2	GPIO3	
	ADC1_CH3	GPIO4	
	ADC1_CH4	GPIO5	
	ADC1_CH5	GPIO6	
	ADC1_CH6	GPIO7	
	ADC1_CH7	GPIO8	
	ADC1_CH8	GPIO9	
	ADC1_CH9	GPIO10	
	ADC2_CH0	GPIO11	
	ADC2_CH1	GPIO12	
	ADC2_CH2	GPIO13	
	ADC2_CH3	GPIO14	
	ADC2_CH4	XTAL_32K_P	
	ADC2_CH5	XTAL_32K_N	
	ADC2_CH6	GPIO17	
	ADC2_CH7	GPIO18	
	ADC2_CH8	GPIO19	
ADC2_CH9	GPIO20		

Interface	Signal	Pin	Function
Touch sensor	TOUCH1	GPIO1	Capacitive touch sensors
	TOUCH2	GPIO2	
	TOUCH3	GPIO3	
	TOUCH4	GPIO4	
	TOUCH5	GPIO5	
	TOUCH6	GPIO6	
	TOUCH7	GPIO7	
	TOUCH8	GPIO8	
	TOUCH9	GPIO9	
	TOUCH10	GPIO10	
	TOUCH11	GPIO11	
	TOUCH12	GPIO12	
	TOUCH13	GPIO13	
	TOUCH14	GPIO14	
JTAG	MTDI	MTDI	JTAG for software debugging
	MTCK	MTCK	
	MTMS	MTMS	
	MTDO	MTDO	
UART	U0RXD_in	Any GPIO pins	Three UART devices with hardware flow-control and DMA
	U0CTS_in		
	U0DSR_in		
	U0TXD_out		
	U0RTS_out		
	U0DTR_out		
	U1RXD_in		
	U1CTS_in		
	U1DSR_in		
	U1TXD_out		
	U1RTS_out		
	U1DTR_out		
	U2RXD_in		
	U2CTS_in		
	U2DSR_in		
	U2TXD_out		
U2RTS_out			
U2DTR_out			
I2C	I2CEXT0_SCL_in/_out	Any GPIO pins	Two I2C devices in slave or master mode
	I2CEXT0_SDA_in/_out		
	I2CEXT1_SCL_in/_out		
	I2CEXT1_SDA_in/_out		
LED PWM	LEDC_LS_SIG_out0~7	Any GPIO pins	Eight independent channels.

Interface	Signal	Pin	Function
I2S	I2S00_BCK_in	Any GPIO pins	Stereo input and output from/to the audio codec
	I2S0_MCLK_in		
	I2S00_WS_in		
	I2S0I_SD_in		
	I2S0I_SD1_in		
	I2S0I_SD2_in		
	I2S0I_SD3_in		
	I2S0I_BCK_in		
	I2S0I_WS_in		
	I2S10_BCK_in		
	I2S1_MCLK_in		
	I2S10_WS_in		
	I2S1I_SD_in		
	I2S1I_BCK_in		
	I2S1I_WS_in		
	I2S00_BCK_out		
	I2S0_MCLK_out		
	I2S00_WS_out		
	I2S00_SD_out		
	I2S00_SD1_out		
	I2S0I_BCK_out		
	I2S0I_WS_out		
	I2S10_BCK_out		
	I2S1_MCLK_out		
	I2S10_WS_out		
	I2S10_SD_out		
I2S1I_BCK_out			
I2S1I_WS_out			
LCD_CAMERA	LCD_PCLK	Any GPIO pins	8 ~16 data transmission to LCD interface and 8 ~16 data reception by camera interface
	LCD_DC		
	LCD_V_SYNC		
	LCD_H_SYNC		
	LCD_H_ENABLE		
	LCD_DATA_out0~15		
	LCD_CS		
	CAM_CLK		
	CAM_V_SYNC		
	CAM_H_SYNC		
	CAM_H_ENABLE		
	CAM_PCLK		
	CAM_DATA_in0~15		
Remote Control Peripheral	RMT_SIG_in0~3	Any GPIO pins	Four channels for an IR transceiver of various wave forms
	RMT_SIG_out0~3		

Interface	Signal	Pin	Function
SPI0/1	SPICLK_out_mux	SPICLK	Support Standard SPI, Dual SPI, QSPI, QPI, OSPI, and OPI that allow connection to external flash and RAM.
	SPICS0_out	SPICS0	
	SPICS1_out	SPICS1	
	SPID_in/_out	SPID	
	SPIQ_in/_out	SPIQ	
	SPIWP_in/_out	SPIWP	
	SPIHD_in/_out	SPIHD	
	SPID4_in/_out	GPIO33	
	SPID5_in/_out	GPIO34	
	SPID6_in/_out	GPIO35	
	SPID7_in/_out	GPIO36	
	SPIDQS_in/_out	GPIO37	
SPI2	FSPICLK_in/_out_mux	Any GPIO pins	Support: <ul style="list-style-type: none"> <li>• master mode of SPI, Dual SPI, Quad SPI, Octal SPI, QPI, and OPI, and slave mode of SPI, Dual SPI, Quad SPI, and QPI;</li> <li>• connection to external flash, RAM, and other SPI devices;</li> <li>• four modes of SPI transfer format;</li> <li>• configurable SPI frequency;</li> <li>• 64-byte FIFO or DMA buffer.</li> </ul>
	FSPICS0_in/_out		
	FSPICS1~5_out		
	FSPID_in/_out		
	FSPIQ_in/_out		
	FSPIWP_in/_out		
	FSPIHD_in/_out		
	FSPIIO4~7_in/_out		
	FSPIDQS_out		
SPI3	SPI3_CLK_in/_out_mux	Any GPIO pins	Support: <ul style="list-style-type: none"> <li>• master and slave modes of SPI, Dual SPI, Quad SPI, and QPI;</li> <li>• four modes of SPI transfer format;</li> <li>• configurable frequency;</li> <li>• 64-byte FIFO or DMA buffer.</li> </ul>
	SPI3_CS0_in/_out		
	SPI3_CS1_out		
	SPI3_CS2_out		
	SPI3_D_in/_out		
	SPI3_Q_in/_out		
	SPI3_WP_in/_out		
	SPI3_HD_in/_out		
Pulse counter	PCNT_SIG_CH0_in0~3	Any GPIO pins	Capture pulse and count pulse edges in seven modes
	PCNT_SIG_CH1_in0~3		
	PCNT_CTRL_CH0_in0~3		
	PCNT_CTRL_CH1_in0~3		

Interface	Signal	Pin	Function
USB OTG	D-	GPIO19 (for internal PHY)	Full-speed USB OTG (USB OTG supports both full-speed on-chip PHY and external PHY)
	D+	GPIO20 (for internal PHY)	
	VP	MTMS (for external PHY)	
	VM	MTDI (for external PHY)	
	RCV	GPIO21 (for external PHY)	
	OEN	MTDO (for external PHY)	
	VPO	MTCK (for external PHY)	
	VMO	GPIO38 (for external PHY)	
USB Serial/JTAG controller	D-	GPIO19 (for internal PHY)	Flash programming and CPU debugging (USB Serial/JTAG controller supports both full-speed on-chip PHY and external PHY)
	D+	GPIO20 (for internal PHY)	
	VP	MTMS (for external PHY)	
	VM	MTDI (for external PHY)	
	OEN	MTDO (for external PHY)	
	VPO	MTCK (for external PHY)	
	VMO	GPIO38 (for external PHY)	
SD/MMC Host Controller	SDHOST_CCLK_out_1~2	Any GPIO pins	Secure Digital (SD) memory version 3.0.1 supported
	SDHOST_RST_N_1~2		
	SD-HOST_CCMD_OD_PULLUP_EN_N		
	SDIO_TOHOST_INT_out		
	SDHOST_CCMD_in/_out_1		
	SDHOST_CCMD_in/_out_2		
	SDHOST_CDATA_in/_out_10		
	SDHOST_CDATA_in/_out_11		
	SDHOST_CDATA_in/_out_12		
	SDHOST_CDATA_in/_out_13		
	SDHOST_CDATA_in/_out_14		
	SDHOST_CDATA_in/_out_15		
	SDHOST_CDATA_in/_out_16		
	SDHOST_CDATA_in/_out_17		
	SDHOST_CDATA_in/_out_20		
	SDHOST_CDATA_in/_out_21		
	SDHOST_CDATA_in/_out_22		
	SDHOST_CDATA_in/_out_23		
	SDHOST_CDATA_in/_out_24		
	SDHOST_CDATA_in/_out_25		
	SDHOST_CDATA_in/_out_26		
	SDHOST_CDATA_in/_out_27		
	SDHOST_DATA_STROBE_1~2		
SDHOST_CARD_DETECT_N_1~2			
SD-HOST_CARD_WRITE_PRT_1~2			
SDHOST_CARD_INT_N_1~2			

Interface	Signal	Pin	Function
MCPWM	PWM0_SYNC0~2_in	Any GPIO pins	Two MCPWM input and output pins. Signals include PWM differential output signals, fault input signals to be detected, input signals to be captured, and external clock synchronization signals
	PWM0_F0~2_in		
	PWM0_CAP0~2_in		
	PWM1_SYNC0~2_in		
	PWM1_F0~2_in		
	PWM1_CAP0~2_in		
	PWM0_out0a		
	PWM0_out0b		
	PWM0_out1a		
	PWM0_out1b		
	PWM0_out2a		
	PWM0_out2b		
	PWM1_out0a		
	PWM1_out0b		
	PWM1_out1a		
	PWM1_out1b		
	PWM1_out2a		
PWM1_out2b			
TWAI® Controller	TWAI_RX	Any GPIO pins	Compatible with ISO 11898-1 protocol (CAN Specification 2.0). Data rate up to 1 Mbit/s
	TWAI_TX		
	TWAI_BUS_OFF_ON		
	TWAI_CLKOUT		

## 4 Electrical Characteristics

### 4.1 Absolute Maximum Ratings

Stresses above those listed in Table 4-1 *Absolute Maximum Ratings* may cause permanent damage to the device. These are stress ratings only and normal operation of the device at these or any other conditions beyond those indicated in Section 4.2 *Recommended Power Supply Characteristics* is not implied. Exposure to absolute-maximum-rated conditions for extended periods may affect device reliability.

**Table 4-1. Absolute Maximum Ratings**

Parameter	Description	Min	Max	Unit
Input power pins <sup>1</sup>	Allowed input voltage	-0.3	3.6	V
$I_{output}$ <sup>2</sup>	Cumulative IO output current	—	1500	mA
$T_{STORE}$	Storage temperature	-40	150	°C

<sup>1</sup> For more information on input power pins, see Section 2.5.1 *Power Pins*.

<sup>2</sup> The product proved to be fully functional after all its IO pins were pulled high while being connected to ground for 24 consecutive hours at ambient temperature of 25 °C.

### 4.2 Recommended Power Supply Characteristics

For recommended ambient temperature, see Section 1 *ESP32-S3 Series Comparison*.

**Table 4-2. Recommended Power Characteristics**

Parameter <sup>1</sup>	Description	Min	Typ	Max	Unit
VDDA, VDD3P3	Recommended input voltage	3.0	3.3	3.6	V
VDD3P3_RTC <sup>2</sup>	Recommended input voltage	3.0	3.3	3.6	V
VDD_SPI (as input)	—	1.8	3.3	3.6	V
VDD3P3_CPU <sup>3</sup>	Recommended input voltage	3.0	3.3	3.6	V
$I_{VDD}$ <sup>4</sup>	Cumulative input current	0.5	—	—	A

<sup>1</sup> See in conjunction with Section 2.5 *Power Supply*.

<sup>2</sup> If VDD3P3\_RTC is used to power VDD\_SPI (see Section 2.5.2 *Power Scheme*), the voltage drop on  $R_{SPI}$  should be accounted for. See also Section 4.3 *VDD\_SPI Output Characteristics*.

<sup>3</sup> If writing to eFuses, the voltage on VDD3P3\_CPU should not exceed 3.3 V as the circuits responsible for burning eFuses are sensitive to higher voltages.

<sup>4</sup> If you use a single power supply, the recommended output current is 500 mA or more.



### 4.3 VDD\_SPI Output Characteristics

Table 4-3. VDD\_SPI Internal and Output Characteristics

Parameter	Description <sup>1</sup>	Typ	Unit
$R_{SPI}$	VDD_SPI powered by VDD3P3_RTC via $R_{SPI}$ for 3.3 V flash/PSRAM <sup>2</sup>	14	$\Omega$
$I_{SPI}$	Output current when VDD_SPI is powered by Flash Voltage Regulator for 1.8 V flash/PSRAM	40	mA

<sup>1</sup> See in conjunction with Section 2.5.2 Power Scheme.

<sup>2</sup> VDD3P3\_RTC must be more than  $VDD_{flash\_min} + I_{flash\_max} * R_{SPI}$ ;

where

- $VDD_{flash\_min}$  – minimum operating voltage of flash/PSRAM
- $I_{flash\_max}$  – maximum operating current of flash/PSRAM

### 4.4 DC Characteristics (3.3 V, 25 °C)

Table 4-4. DC Characteristics (3.3 V, 25 °C)

Symbol	Parameter	Min	Typ	Max	Unit
$C_{IN}$	Pin capacitance	—	2	—	pF
$V_{IH}$	High-level input voltage	$0.75 \times VDD^1$	—	$VDD^1 + 0.3$	V
$V_{IL}$	Low-level input voltage	-0.3	—	$0.25 \times VDD^1$	V
$I_{IH}$	High-level input current	—	—	50	nA
$I_{IL}$	Low-level input current	—	—	50	nA
$V_{OH}^2$	High-level output voltage	$0.8 \times VDD^1$	—	—	V
$V_{OL}^2$	Low-level output voltage	—	—	$0.1 \times VDD^1$	V
$I_{OH}$	High-level source current ( $VDD^1 = 3.3$ V, $V_{OH} \geq 2.64$ V, PAD_DRIVER = 3)	—	40	—	mA
$I_{OL}$	Low-level sink current ( $VDD^1 = 3.3$ V, $V_{OL} = 0.495$ V, PAD_DRIVER = 3)	—	28	—	mA
$R_{PU}$	Internal weak pull-up resistor	—	45	—	k $\Omega$
$R_{PD}$	Internal weak pull-down resistor	—	45	—	k $\Omega$
$V_{IH\_nRST}$	Chip reset release voltage (CHIP_PU voltage is within the specified range)	$0.75 \times VDD^1$	—	$VDD^1 + 0.3$	V
$V_{IL\_nRST}$	Chip reset voltage (CHIP_PU voltage is within the specified range)	-0.3	—	$0.25 \times VDD^1$	V

<sup>1</sup> VDD is the I/O voltage for a particular power domain of pins.

<sup>2</sup>  $V_{OH}$  and  $V_{OL}$  are measured using high-impedance load.

## 4.5 ADC Characteristics

Table 4-5. ADC Characteristics

Symbol	Parameter	Min	Max	Unit
DNL (Differential nonlinearity) <sup>1</sup>	ADC connected to an external 100 nF capacitor; DC signal input;	-4	4	LSB
INL (Integral nonlinearity)	Ambient temperature at 25 °C; Wi-Fi off	-8	8	LSB
Sampling rate	—	—	100	kSPS <sup>2</sup>
Effective Range	ATTEN0	0	850	mV
	ATTEN1	0	1100	mV
	ATTEN2	0	1600	mV
	ATTEN3	0	2900	mV

<sup>1</sup> To get better DNL results, you can sample multiple times and apply a filter, or calculate the average value.

<sup>2</sup> kSPS means kilo samples-per-second.

## 4.6 Current Consumption

### 4.6.1 RF Current Consumption in Active Mode

The current consumption measurements are taken with a 3.3 V supply at 25 °C of ambient temperature at the RF port. All transmitters' measurements are based on a 100% duty cycle.

Table 4-6. Wi-Fi Current Consumption Depending on RF Modes

Work Mode <sup>1</sup>	Description	Peak (mA)	
Active (RF working)	TX	802.11b, 1 Mbps, @21 dBm	340
		802.11g, 54 Mbps, @19 dBm	291
		802.11n, HT20, MCS7, @18.5 dBm	283
		802.11n, HT40, MCS7, @18 dBm	286
	RX	802.11b/g/n, HT20	88
		802.11n, HT40	91

<sup>1</sup> The CPU work mode: Single core runs 32-bit data access instructions at 80 MHz, the other core is in idle state.

### 4.6.2 Current Consumption in Other Modes

The measurements below are applicable to ESP32-S3 and ESP32-S3FH8. Since ESP32-S3R2, ESP32-S3R8, ESP32-S3R8V, and ESP32-S3FN4R2 are embedded with PSRAM, their current consumption might be higher.

Table 4-7. Current Consumption in Modem-sleep Mode

Work mode	Frequency (MHz)	Description	Typ <sup>1</sup> (mA)	Typ <sup>2</sup> (mA)
Modem-sleep <sup>3</sup>	40	WAITI (Dual core in idle state)	13.2	18.8
		Single core running 32-bit data access instructions, the other core in idle state	16.2	21.8
		Dual core running 32-bit data access instructions	18.7	24.4
		Single core running 128-bit data access instructions, the other core in idle state	19.9	25.4
		Dual core running 128-bit data access instructions	23.0	28.8
	80	WAITI	22.0	36.1
		Single core running 32-bit data access instructions, the other core in idle state	28.4	42.6
		Dual core running 32-bit data access instructions	33.1	47.3
		Single core running 128-bit data access instructions, the other core in idle state	35.1	49.6
		Dual core running 128-bit data access instructions	41.8	56.3
	160	WAITI	27.6	42.3
		Single core running 32-bit data access instructions, the other core in idle state	39.9	54.6
		Dual core running 32-bit data access instructions	49.6	64.1
		Single core running 128-bit data access instructions, the other core in idle state	54.4	69.2
		Dual core running 128-bit data access instructions	66.7	81.1
	240	WAITI	32.9	47.6
		Single core running 32-bit data access instructions, the other core in idle state	51.2	65.9
		Dual core running 32-bit data access instructions	66.2	81.3
		Single core running 128-bit data access instructions, the other core in idle state	72.4	87.9
		Dual core running 128-bit data access instructions	91.7	107.9

<sup>1</sup> Current consumption when all peripheral clocks are **disabled**.

<sup>2</sup> Current consumption when all peripheral clocks are **enabled**. In practice, the current consumption might be different depending on which peripherals are enabled.

<sup>3</sup> In Modem-sleep mode, Wi-Fi is clock gated, and the current consumption might be higher when accessing flash. For a flash rated at 80 Mbit/s, in SPI 2-line mode the consumption is 10 mA.

Table 4-8. Current Consumption in Low-Power Modes

Work mode	Description	Typ ( $\mu$ A)
Light-sleep <sup>1</sup>	VDD_SPI and Wi-Fi are powered down, and all GPIOs are high-impedance.	240
Deep-sleep	RTC memory and RTC peripherals are powered up.	8
	RTC memory is powered up. RTC peripherals are powered down.	7

Power off	CHIP_PU is set to low level. The chip is shut down.	1
-----------	---	---

<sup>1</sup> In Light-sleep mode, all related SPI pins are pulled up. For chips embedded with PSRAM, please add corresponding PSRAM consumption values, e.g., 140  $\mu$ A for 8 MB 8-line PSRAM (3.3 V), 200  $\mu$ A for 8 MB 8-line PSRAM (1.8 V) and 40  $\mu$ A for 2 MB 4-line PSRAM (3.3 V).

## 4.7 Reliability

**Table 4-9. Reliability Qualifications**

Test Item	Test Conditions	Test Standard
HTOL (High Temperature Operating Life)	125 °C, 1000 hours	JESD22-A108
ESD (Electro-Static Discharge Sensitivity)	HBM (Human Body Mode) <sup>1</sup> ± 2000 V	JS-001
	CDM (Charge Device Mode) <sup>2</sup> ± 1000 V	JS-002
Latch up	Current trigger ± 200 mA	JESD78
	Voltage trigger $1.5 \times VDD_{max}$	
Preconditioning	Bake 24 hours @125 °C Moisture soak (level 3: 192 hours @30 °C, 60% RH) IR reflow solder: 260 + 0 °C, 20 seconds, three times	J-STD-020, JESD47, JESD22-A113
TCT (Temperature Cycling Test)	-65 °C / 150 °C, 500 cycles	JESD22-A104
uHAST (Highly Accelerated Stress Test, unbiased)	130 °C, 85% RH, 96 hours	JESD22-A118
HTSL (High Temperature Storage Life)	150 °C, 1000 hours	JESD22-A103
LTSL (Low Temperature Storage Life)	-40 °C, 1000 hours	JESD22-A119

<sup>1</sup> JEDEC document JEP155 states that 500 V HBM allows safe manufacturing with a standard ESD control process.

<sup>2</sup> JEDEC document JEP157 states that 250 V CDM allows safe manufacturing with a standard ESD control process.

## 4.8 Wi-Fi Radio

Table 4-10. Wi-Fi Frequency

Parameter	Min (MHz)	Typ (MHz)	Max (MHz)
Center frequency of operating channel	2412	—	2484

### 4.8.1 Wi-Fi RF Transmitter (TX) Specifications

Table 4-11. TX Power with Spectral Mask and EVM Meeting 802.11 Standards

Rate	Min (dBm)	Typ (dBm)	Max (dBm)
802.11b, 1 Mbps	—	21.0	—
802.11b, 11 Mbps	—	21.0	—
802.11g, 6 Mbps	—	20.5	—
802.11g, 54 Mbps	—	19.0	—
802.11n, HT20, MCS0	—	19.5	—
802.11n, HT20, MCS7	—	18.5	—
802.11n, HT40, MCS0	—	19.5	—
802.11n, HT40, MCS7	—	18.0	—

Table 4-12. TX EVM Test

Rate	Min (dB)	Typ (dB)	SL <sup>1</sup> (dB)
802.11b, 1 Mbps, @21 dBm	—	-24.5	-10
802.11b, 11 Mbps, @21 dBm	—	-24.5	-10
802.11g, 6 Mbps, @20.5 dBm	—	-21.5	-5
802.11g, 54 Mbps, @19 dBm	—	-28.0	-25
802.11n, HT20, MCS0, @19.5 dBm	—	-23.0	-5
802.11n, HT20, MCS7, @18.5 dBm	—	-29.5	-27
802.11n, HT40, MCS0, @19.5 dBm	—	-23.0	-5
802.11n, HT40, MCS7, @18 dBm	—	-29.5	-27

<sup>1</sup> SL stands for standard limit value.

## 4.8.2 Wi-Fi RF Receiver (RX) Specifications

Table 4-13. RX Sensitivity

Rate	Min (dBm)	Typ (dBm)	Max (dBm)
802.11b, 1 Mbps	—	-98.4	—
802.11b, 2 Mbps	—	-95.4	—
802.11b, 5.5 Mbps	—	-93.0	—
802.11b, 11 Mbps	—	-88.6	—
802.11g, 6 Mbps	—	-93.2	—
802.11g, 9 Mbps	—	-91.8	—
802.11g, 12 Mbps	—	-91.2	—
802.11g, 18 Mbps	—	-88.6	—
802.11g, 24 Mbps	—	-86.0	—
802.11g, 36 Mbps	—	-82.4	—
802.11g, 48 Mbps	—	-78.2	—
802.11g, 54 Mbps	—	-76.5	—
802.11n, HT20, MCS0	—	-92.6	—
802.11n, HT20, MCS1	—	-91.0	—
802.11n, HT20, MCS2	—	-88.2	—
802.11n, HT20, MCS3	—	-85.0	—
802.11n, HT20, MCS4	—	-81.8	—
802.11n, HT20, MCS5	—	-77.4	—
802.11n, HT20, MCS6	—	-75.8	—
802.11n, HT20, MCS7	—	-74.2	—
802.11n, HT40, MCS0	—	-90.0	—
802.11n, HT40, MCS1	—	-88.0	—
802.11n, HT40, MCS2	—	-85.2	—
802.11n, HT40, MCS3	—	-82.0	—
802.11n, HT40, MCS4	—	-79.0	—
802.11n, HT40, MCS5	—	-74.4	—
802.11n, HT40, MCS6	—	-72.8	—
802.11n, HT40, MCS7	—	-71.4	—

Table 4-14. Maximum RX Level

Rate	Min (dBm)	Typ (dBm)	Max (dBm)
802.11b, 1 Mbps	—	5	—
802.11b, 11 Mbps	—	5	—
802.11g, 6 Mbps	—	5	—
802.11g, 54 Mbps	—	0	—
802.11n, HT20, MCS0	—	5	—

Cont'd on next page

Table 4-14 – cont'd from previous page

Rate	Min (dBm)	Typ (dBm)	Max (dBm)
802.11n, HT20, MCS7	—	0	—
802.11n, HT40, MCS0	—	5	—
802.11n, HT40, MCS7	—	0	—

Table 4-15. RX Adjacent Channel Rejection

Rate	Min (dB)	Typ (dB)	Max (dB)
802.11b, 1 Mbps	—	35	—
802.11b, 11 Mbps	—	35	—
802.11g, 6 Mbps	—	31	—
802.11g, 54 Mbps	—	20	—
802.11n, HT20, MCS0	—	31	—
802.11n, HT20, MCS7	—	16	—
802.11n, HT40, MCS0	—	25	—
802.11n, HT40, MCS7	—	11	—

## 4.9 Bluetooth LE Radio

Table 4-16. Bluetooth LE Frequency

Parameter	Min (MHz)	Typ (MHz)	Max (MHz)
Center frequency of operating channel	2402	—	2480

### 4.9.1 Bluetooth LE RF Transmitter (TX) Specifications

Table 4-17. Transmitter Characteristics - Bluetooth LE 1 Mbps

Parameter	Description	Min	Typ	Max	Unit
RF transmit power	RF power control range	-24.00	0	20.00	dBm
	Gain control step	—	3.00	—	dB
Carrier frequency offset and drift	$\text{Max }  f_n _{n=0, 1, 2, \dots, k}$	—	2.50	—	kHz
	$\text{Max }  f_0 - f_n $	—	2.00	—	kHz
	$\text{Max }  f_n - f_{n-5} $	—	1.39	—	kHz
	$ f_1 - f_0 $	—	0.80	—	kHz
Modulation characteristics	$\Delta f_{1\text{avg}}$	—	249.00	—	kHz
	Min $\Delta f_{2\text{max}}$ (for at least 99.9% of all $\Delta f_{2\text{max}}$ )	—	198.00	—	kHz
	$\Delta f_{2\text{avg}}/\Delta f_{1\text{avg}}$	—	0.86	—	—

Cont'd on next page

Table 4-17 – cont'd from previous page

Parameter	Description	Min	Typ	Max	Unit
In-band spurious emissions	±2 MHz offset	—	-37.00	—	dBm
	±3 MHz offset	—	-42.00	—	dBm
	>±3 MHz offset	—	-44.00	—	dBm

Table 4-18. Transmitter Characteristics - Bluetooth LE 2 Mbps

Parameter	Description	Min	Typ	Max	Unit
RF transmit power	RF power control range	-24.00	0	20.00	dBm
	Gain control step	—	3.00	—	dB
Carrier frequency offset and drift	Max $ f_n _{n=0, 1, 2, \dots, k}$	—	2.50	—	kHz
	Max $ f_0 - f_n $	—	1.90	—	kHz
	Max $ f_n - f_{n-5} $	—	1.40	—	kHz
	$ f_1 - f_0 $	—	1.10	—	kHz
Modulation characteristics	$\Delta f_{1avg}$	—	499.00	—	kHz
	Min $\Delta f_{2max}$ (for at least 99.9% of all $\Delta f_{2max}$ )	—	416.00	—	kHz
	$\Delta f_{2avg}/\Delta f_{1avg}$	—	0.89	—	—
In-band spurious emissions	±4 MHz offset	—	-43.80	—	dBm
	±5 MHz offset	—	-45.80	—	dBm
	>±5 MHz offset	—	-47.00	—	dBm

Table 4-19. Transmitter Characteristics - Bluetooth LE 125 Kbps

Parameter	Description	Min	Typ	Max	Unit
RF transmit power	RF power control range	-24.00	0	20.00	dBm
	Gain control step	—	3.00	—	dB
Carrier frequency offset and drift	Max $ f_n _{n=0, 1, 2, \dots, k}$	—	0.80	—	kHz
	Max $ f_0 - f_n $	—	0.98	—	kHz
	$ f_n - f_{n-3} $	—	0.30	—	kHz
	$ f_0 - f_3 $	—	1.00	—	kHz
Modulation characteristics	$\Delta f_{1avg}$	—	248.00	—	kHz
	Min $\Delta f_{1max}$ (for at least 99.9% of all $\Delta f_{1max}$ )	—	222.00	—	kHz
In-band spurious emissions	±2 MHz offset	—	-37.00	—	dBm
	±3 MHz offset	—	-42.00	—	dBm
	>±3 MHz offset	—	-44.00	—	dBm

Table 4-20. Transmitter Characteristics - Bluetooth LE 500 Kbps

Parameter	Description	Min	Typ	Max	Unit
RF transmit power	RF power control range	-24.00	0	20.00	dBm
	Gain control step	—	3.00	—	dB

Cont'd on next page



Table 4-20 – cont'd from previous page

Parameter	Description	Min	Typ	Max	Unit
Carrier frequency offset and drift	Max $ f_n _{n=0, 1, 2, \dots, k}$	—	0.70	—	kHz
	Max $ f_0 - f_n $	—	0.90	—	kHz
	$ f_n - f_{n-3} $	—	0.85	—	kHz
	$ f_0 - f_3 $	—	0.34	—	kHz
Modulation characteristics	$\Delta f_{2avg}$	—	213.00	—	kHz
	Min $\Delta f_{2max}$ (for at least 99.9% of all $\Delta f_{2max}$ )	—	196.00	—	kHz
In-band spurious emissions	$\pm 2$ MHz offset	—	-37.00	—	dBm
	$\pm 3$ MHz offset	—	-42.00	—	dBm
	$> \pm 3$ MHz offset	—	-44.00	—	dBm

#### 4.9.2 Bluetooth LE RF Receiver (RX) Specifications

Table 4-21. Receiver Characteristics - Bluetooth LE 1 Mbps

Parameter	Description	Min	Typ	Max	Unit
Sensitivity @30.8% PER	—	—	-97.5	—	dBm
Maximum received signal @30.8% PER	—	—	8	—	dBm
Co-channel C/I	F = F0 MHz	—	9	—	dB
Adjacent channel selectivity C/I	F = F0 + 1 MHz	—	-3	—	dB
	F = F0 - 1 MHz	—	-3	—	dB
	F = F0 + 2 MHz	—	-28	—	dB
	F = F0 - 2 MHz	—	-30	—	dB
	F = F0 + 3 MHz	—	-31	—	dB
	F = F0 - 3 MHz	—	-33	—	dB
	F > F0 + 3 MHz	—	-32	—	dB
F > F0 - 3 MHz	—	-36	—	dB	
Image frequency	—	—	-32	—	dB
Adjacent channel to image frequency	F = F <sub>image</sub> + 1 MHz	—	-39	—	dB
	F = F <sub>image</sub> - 1 MHz	—	-31	—	dB
Out-of-band blocking performance	30 MHz ~ 2000 MHz	—	-9	—	dBm
	2003 MHz ~ 2399 MHz	—	-19	—	dBm
	2484 MHz ~ 2997 MHz	—	-16	—	dBm
	3000 MHz ~ 12.75 GHz	—	-5	—	dBm
Intermodulation	—	—	-31	—	dBm

Table 4-22. Receiver Characteristics - Bluetooth LE 2 Mbps

Parameter	Description	Min	Typ	Max	Unit
Sensitivity @30.8% PER	—	—	-93.5	—	dBm
Maximum received signal @30.8% PER	—	—	3	—	dBm
Co-channel C/I	$F = F_0$ MHz	—	10	—	dB
Adjacent channel selectivity C/I	$F = F_0 + 2$ MHz	—	-8	—	dB
	$F = F_0 - 2$ MHz	—	-5	—	dB
	$F = F_0 + 4$ MHz	—	-31	—	dB
	$F = F_0 - 4$ MHz	—	-33	—	dB
	$F = F_0 + 6$ MHz	—	-37	—	dB
	$F = F_0 - 6$ MHz	—	-37	—	dB
	$F > F_0 + 6$ MHz	—	-40	—	dB
	$F > F_0 - 6$ MHz	—	-40	—	dB
Image frequency	—	—	-31	—	dB
Adjacent channel to image frequency	$F = F_{image} + 2$ MHz	—	-37	—	dB
	$F = F_{image} - 2$ MHz	—	-8	—	dB
Out-of-band blocking performance	30 MHz ~ 2000 MHz	—	-16	—	dBm
	2003 MHz ~ 2399 MHz	—	-20	—	dBm
	2484 MHz ~ 2997 MHz	—	-16	—	dBm
	3000 MHz ~ 12.75 GHz	—	-16	—	dBm
Intermodulation	—	—	-30	—	dBm

Table 4-23. Receiver Characteristics - Bluetooth LE 125 Kbps

Parameter	Description	Min	Typ	Max	Unit
Sensitivity @30.8% PER	—	—	-104.5	—	dBm
Maximum received signal @30.8% PER	—	—	8	—	dBm
Co-channel C/I	$F = F_0$ MHz	—	6	—	dB
Adjacent channel selectivity C/I	$F = F_0 + 1$ MHz	—	-6	—	dB
	$F = F_0 - 1$ MHz	—	-5	—	dB
	$F = F_0 + 2$ MHz	—	-32	—	dB
	$F = F_0 - 2$ MHz	—	-39	—	dB
	$F = F_0 + 3$ MHz	—	-35	—	dB
	$F = F_0 - 3$ MHz	—	-45	—	dB
	$F > F_0 + 3$ MHz	—	-35	—	dB
	$F > F_0 - 3$ MHz	—	-48	—	dB
Image frequency	—	—	-35	—	dB
Adjacent channel to image frequency	$F = F_{image} + 1$ MHz	—	-49	—	dB
	$F = F_{image} - 1$ MHz	—	-32	—	dB

Table 4-24. Receiver Characteristics - Bluetooth LE 500 Kbps

Parameter	Description	Min	Typ	Max	Unit
Sensitivity @30.8% PER	—	—	-101	—	dBm
Maximum received signal @30.8% PER	—	—	8	—	dBm
Co-channel C/I	$F = F_0$ MHz	—	4	—	dB
Adjacent channel selectivity C/I	$F = F_0 + 1$ MHz	—	-5	—	dB
	$F = F_0 - 1$ MHz	—	-5	—	dB
	$F = F_0 + 2$ MHz	—	-28	—	dB
	$F = F_0 - 2$ MHz	—	-36	—	dB
	$F = F_0 + 3$ MHz	—	-36	—	dB
	$F = F_0 - 3$ MHz	—	-38	—	dB
	$F > F_0 + 3$ MHz	—	-37	—	dB
	$F > F_0 - 3$ MHz	—	-41	—	dB
Image frequency	—	—	-37	—	dB
Adjacent channel to image frequency	$F = F_{image} + 1$ MHz	—	-44	—	dB
	$F = F_{image} - 1$ MHz	—	-28	—	dB

## 5 Packaging

- For information about tape, reel, and product marking, please refer to [Espressif Chip Packaging Information](#).
- The pins of the chip are numbered in anti-clockwise order starting from Pin 1 in the top view. For pin numbers and pin names, see also Figure 2-1 ESP32-S3 Pin Layout (Top View).
- The recommended land pattern [source file \(dxf\)](#) is available for download. You can view the file with [Autodesk Viewer](#).
- All ESP32-S3 chip variants have identical land pattern (see Figure 5-1) except ESP32-S3FH4R2 has a bigger EPAD (see Figure 5-2). The [source file \(dxf\)](#) may be adopted for ESP32-S3FH4R2 by altering the size of the EPAD (see dimensions D2 and E2 in Figure 5-2).

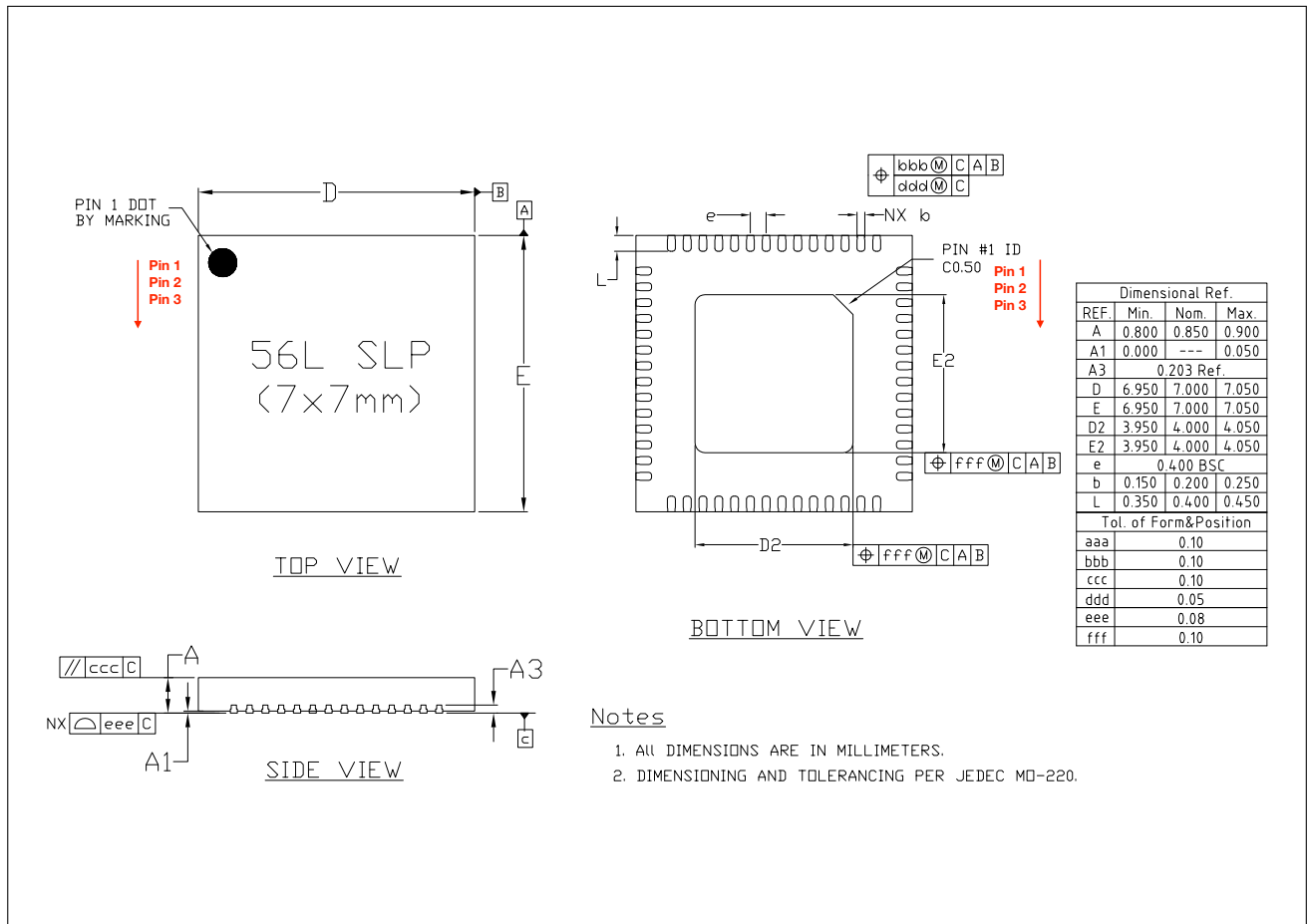

Figure 5-1. QFN56 (7x7 mm) Package

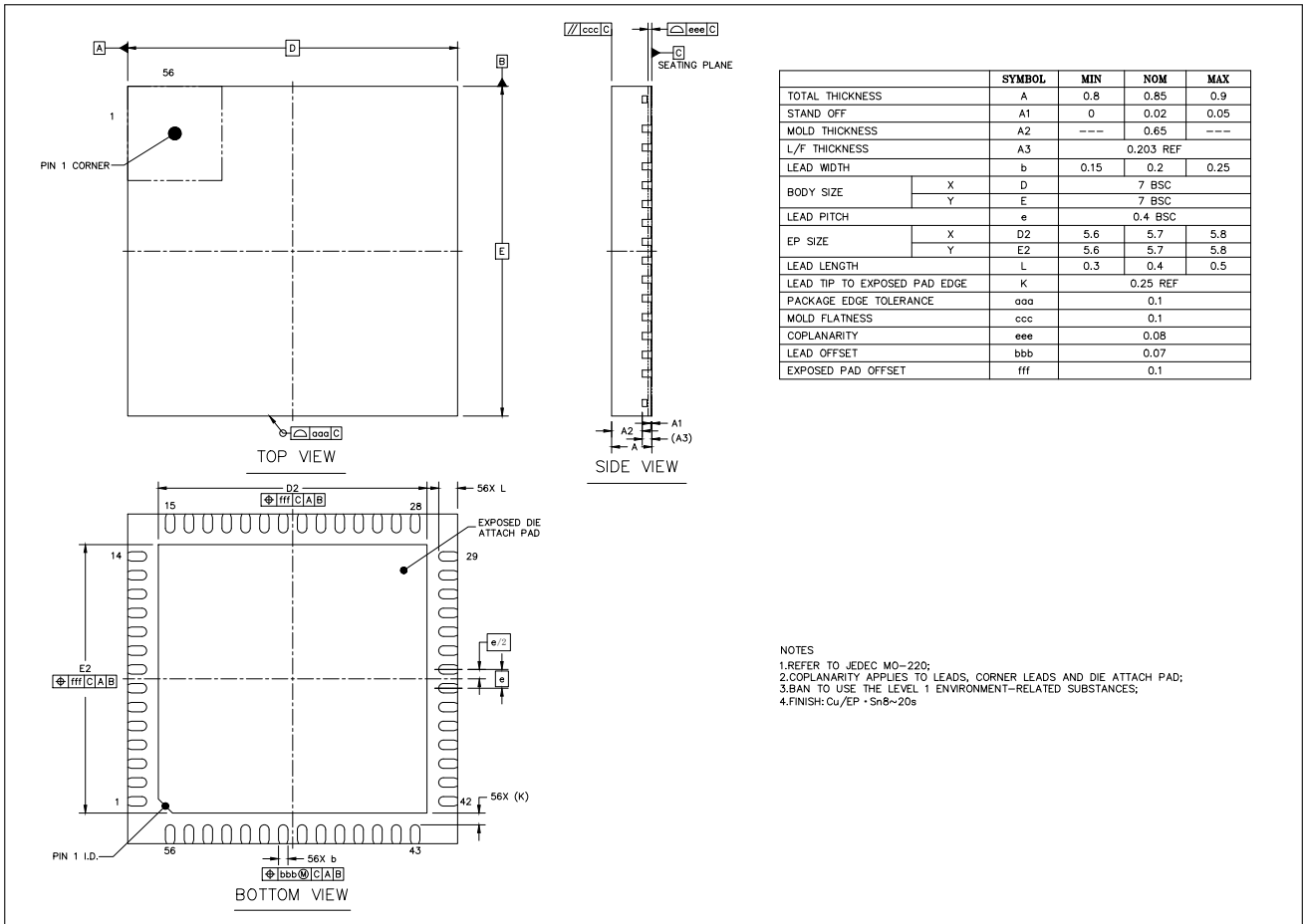

Figure 5-2. QFNWB (7x7 mm) Package for ESP32-S3FH4R2

## 6 Related Documentation and Resources

### Related Documentation

- [ESP32-S3 Technical Reference Manual](#) – Detailed information on how to use the ESP32-S3 memory and peripherals.
- [ESP32-S3 Hardware Design Guidelines](#) – Guidelines on how to integrate the ESP32-S3 into your hardware product.
- [ESP32-S3 Series SoC Errata](#) – Descriptions of known errors in ESP32-S3 series of SoCs.
- *Certificates*  
<https://espressif.com/en/support/documents/certificates>
- *ESP32-S3 Product/Process Change Notifications (PCN)*  
<https://espressif.com/en/support/documents/pcns?keys=ESP32-S3>
- *ESP32-S3 Advisories* – Information on security, bugs, compatibility, component reliability.  
<https://espressif.com/en/support/documents/advisories?keys=ESP32-S3>
- *Documentation Updates and Update Notification Subscription*  
<https://espressif.com/en/support/download/documents>

### Developer Zone

- [ESP-IDF Programming Guide for ESP32-S3](#) – Extensive documentation for the ESP-IDF development framework.
- *ESP-IDF* and other development frameworks on GitHub.  
<https://github.com/espressif>
- *ESP32 BBS Forum* – Engineer-to-Engineer (E2E) Community for Espressif products where you can post questions, share knowledge, explore ideas, and help solve problems with fellow engineers.  
<https://esp32.com/>
- *The ESP Journal* – Best Practices, Articles, and Notes from Espressif folks.  
<https://blog.espressif.com/>
- See the tabs *SDKs and Demos, Apps, Tools, AT Firmware*.  
<https://espressif.com/en/support/download/sdks-demos>

### Products

- *ESP32-S3 Series SoCs* – Browse through all ESP32-S3 SoCs.  
<https://espressif.com/en/products/socs?id=ESP32-S3>
- *ESP32-S3 Series Modules* – Browse through all ESP32-S3-based modules.  
<https://espressif.com/en/products/modules?id=ESP32-S3>
- *ESP32-S3 Series DevKits* – Browse through all ESP32-S3-based devkits.  
<https://espressif.com/en/products/devkits?id=ESP32-S3>
- *ESP Product Selector* – Find an Espressif hardware product suitable for your needs by comparing or applying filters.  
<https://products.espressif.com/#/product-selector?language=en>

### Contact Us

- See the tabs *Sales Questions, Technical Enquiries, Circuit Schematic & PCB Design Review, Get Samples* (Online stores), *Become Our Supplier, Comments & Suggestions*.  
<https://espressif.com/en/contact-us/sales-questions>

# Appendix A – ESP32-S3 Consolidated Pin Overview

Pin No.	Pin Name	Pin Type	Pin Providing Power	Pin Settings		RTC Function		Analog Function		IO MUX Function													
				At Reset	After Reset	0	3	0	1	0	Type	1	Type	2	Type	3	Type	4	Type				
1	LNA_IN	Analog																					
2	VDD3P3	Power																					
3	VDD3P3	Power																					
4	CHIP_PU	Analog	VDD3P3_RTC																				
5	GPIO0	IO	VDD3P3_RTC	IE, WPU	IE, WPU	RTC_GPIO0	sar_i2c_scl_0			GPIO0	I/O/T	GPIO0	I/O/T										
6	GPIO1	IO	VDD3P3_RTC	IE	IE	RTC_GPIO1	sar_i2c_sda_0	TOUCH1	ADC1_CH0	GPIO1	I/O/T	GPIO1	I/O/T										
7	GPIO2	IO	VDD3P3_RTC	IE	IE	RTC_GPIO2	sar_i2c_scl_1	TOUCH2	ADC1_CH1	GPIO2	I/O/T	GPIO2	I/O/T										
8	GPIO3	IO	VDD3P3_RTC	IE	IE	RTC_GPIO3	sar_i2c_sda_1	TOUCH3	ADC1_CH2	GPIO3	I/O/T	GPIO3	I/O/T										
9	GPIO4	IO	VDD3P3_RTC			RTC_GPIO4		TOUCH4	ADC1_CH3	GPIO4	I/O/T	GPIO4	I/O/T										
10	GPIO5	IO	VDD3P3_RTC			RTC_GPIO5		TOUCH5	ADC1_CH4	GPIO5	I/O/T	GPIO5	I/O/T										
11	GPIO6	IO	VDD3P3_RTC			RTC_GPIO6		TOUCH6	ADC1_CH5	GPIO6	I/O/T	GPIO6	I/O/T										
12	GPIO7	IO	VDD3P3_RTC			RTC_GPIO7		TOUCH7	ADC1_CH6	GPIO7	I/O/T	GPIO7	I/O/T										
13	GPIO8	IO	VDD3P3_RTC			RTC_GPIO8		TOUCH8	ADC1_CH7	GPIO8	I/O/T	GPIO8	I/O/T										
14	GPIO9	IO	VDD3P3_RTC		IE	RTC_GPIO9		TOUCH9	ADC1_CH8	GPIO9	I/O/T	GPIO9	I/O/T							SUBSPICS1	O/T		
15	GPIO10	IO	VDD3P3_RTC		IE	RTC_GPIO10		TOUCH10	ADC1_CH9	GPIO10	I/O/T	GPIO10	I/O/T	FSPIO4	I1/O/T	SUBSPICS0	O/T	FSPICS0	I1/O/T				
16	GPIO11	IO	VDD3P3_RTC		IE	RTC_GPIO11		TOUCH11	ADC2_CH0	GPIO11	I/O/T	GPIO11	I/O/T	FSPIO5	I1/O/T	SUBSPID	I1/O/T	FSPID	I1/O/T				
17	GPIO12	IO	VDD3P3_RTC		IE	RTC_GPIO12	ADC2_CH1	TOUCH12	ADC2_CH1	GPIO12	I/O/T	GPIO12	I/O/T	FSPIO6	I1/O/T	SUBSPICLK	O/T	FSPICLK	I1/O/T				
18	GPIO13	IO	VDD3P3_RTC		IE	RTC_GPIO13		TOUCH13	ADC2_CH2	GPIO13	I/O/T	GPIO13	I/O/T	FSPIO7	I1/O/T	SUBSPIQ	I1/O/T	FSPIQ	I1/O/T				
19	GPIO14	IO	VDD3P3_RTC		IE	RTC_GPIO14		TOUCH14	ADC2_CH3	GPIO14	I/O/T	GPIO14	I/O/T	FSPIDQS	O/T	SUBSPWP	I1/O/T	FSPWP	I1/O/T				
20	VDD3P3_RTC	Power																					
21	XTAL_32K_P	IO	VDD3P3_RTC			RTC_GPIO15		XTAL_32K_P	ADC2_CH4	GPIO15	I/O/T	GPIO15	I/O/T	U0RTS	O								
22	XTAL_32K_N	IO	VDD3P3_RTC			RTC_GPIO16		XTAL_32K_N	ADC2_CH5	GPIO16	I/O/T	GPIO16	I/O/T	U0CTS	I1								
23	GPIO17	IO	VDD3P3_RTC		IE	RTC_GPIO17			ADC2_CH6	GPIO17	I/O/T	GPIO17	I/O/T	U1TXD	O								
24	GPIO18	IO	VDD3P3_RTC		IE	RTC_GPIO18			ADC2_CH7	GPIO18	I/O/T	GPIO18	I/O/T	U1RXD	I1	CLK_OUT3	O						
25	GPIO19	IO	VDD3P3_RTC			RTC_GPIO19		USB_D-	ADC2_CH8	GPIO19	I/O/T	GPIO19	I/O/T	U1RTS	O	CLK_OUT2	O						
26	GPIO20	IO	VDD3P3_RTC			RTC_GPIO20		USB_D+	ADC2_CH9	GPIO20	I/O/T	GPIO20	I/O/T	U1CTS	I1	CLK_OUT1	O						
27	GPIO21	IO	VDD3P3_RTC			RTC_GPIO21				GPIO21	I/O/T	GPIO21	I/O/T										
28	SPICS1	IO	VDD_SPI	IE, WPU	IE, WPU					SPICS1	O/T	GPIO26	I/O/T										
29	VDD_SPI	Power																					
30	SPIHD	IO	VDD_SPI	IE, WPU	IE, WPU					SPIHD	I1/O/T	GPIO27	I/O/T										
31	SPWP	IO	VDD_SPI	IE, WPU	IE, WPU					SPWP	I1/O/T	GPIO28	I/O/T										
32	SPICS0	IO	VDD_SPI	IE, WPU	IE, WPU					SPICS0	O/T	GPIO29	I/O/T										
33	SPICLK	IO	VDD_SPI	IE, WPU	IE, WPU					SPICLK	O/T	GPIO30	I/O/T										
34	SPIQ	IO	VDD_SPI	IE, WPU	IE, WPU					SPIQ	I1/O/T	GPIO31	I/O/T										
35	SPID	IO	VDD_SPI	IE, WPU	IE, WPU					SPID	I1/O/T	GPIO32	I/O/T										
36	SPICLK_N	IO	VDD_SPI	IE	IE					SPI_CLK_N_DIFF	O/T	GPIO48	I/O/T	SUBSPI_CLK_N_DIFF	O/T								
37	SPICLK_P	IO	VDD_SPI	IE	IE					SPI_CLK_P_DIFF	O/T	GPIO47	I/O/T	SUBSPI_CLK_P_DIFF	O/T								
38	GPIO33	IO	VDD_SPI / VDD3P3_CPU		IE					GPIO33	I/O/T	GPIO33	I/O/T	FSPIHD	I1/O/T	SUBSPIHD	I1/O/T	SPIO4	I1/O/T				
39	GPIO34	IO	VDD_SPI / VDD3P3_CPU		IE					GPIO34	I/O/T	GPIO34	I/O/T	FSPICS0	I1/O/T	SUBSPICS0	O/T	SPIO5	I1/O/T				
40	GPIO35	IO	VDD_SPI / VDD3P3_CPU		IE					GPIO35	I/O/T	GPIO35	I/O/T	FSPID	I1/O/T	SUBSPID	I1/O/T	SPIO6	I1/O/T				
41	GPIO36	IO	VDD_SPI / VDD3P3_CPU		IE					GPIO36	I/O/T	GPIO36	I/O/T	FSPICLK	I1/O/T	SUBSPICLK	O/T	SPIO7	I1/O/T				
42	GPIO37	IO	VDD_SPI / VDD3P3_CPU		IE					GPIO37	I/O/T	GPIO37	I/O/T	FSPIQ	I1/O/T	SUBSPIQ	I1/O/T	SPIDQS	I0/O/T				
43	GPIO38	IO	VDD3P3_CPU		IE					GPIO38	I/O/T	GPIO38	I/O/T	FSPWP	I1/O/T	SUBSPWP	I1/O/T						
44	MTCK	IO	VDD3P3_CPU		IE*					MTCK	I1	GPIO39	I/O/T	CLK_OUT3	O	SUBSPICS1	O/T						
45	MTDO	IO	VDD3P3_CPU		IE					MTDO	O/T	GPIO40	I/O/T	CLK_OUT2	O								
46	VDD3P3_CPU	Power																					
47	MTDI	IO	VDD3P3_CPU		IE					MTDI	I1	GPIO41	I/O/T	CLK_OUT1	O								
48	MTMS	IO	VDD3P3_CPU		IE					MTMS	I1	GPIO42	I/O/T										
49	U0TXD	IO	VDD3P3_CPU	IE, WPU	IE, WPU					U0TXD	O	GPIO43	I/O/T	CLK_OUT1	O								
50	U0RXD	IO	VDD3P3_CPU	IE, WPU	IE, WPU					U0RXD	I1	GPIO44	I/O/T	CLK_OUT2	O								
51	GPIO45	IO	VDD3P3_CPU	IE, WPD	IE, WPD					GPIO45	I/O/T	GPIO45	I/O/T										
52	GPIO46	IO	VDD3P3_CPU	IE, WPD	IE, WPD					GPIO46	I/O/T	GPIO46	I/O/T										
53	XTAL_N	Analog																					
54	XTAL_P	Analog																					
55	VDDA	Power																					
56	VDDA	Power																					
57	GND	Power																					

\* For details, see Section 2 Pins. Regarding highlighted cells, see Section 2.3.3 Restrictions for GPIOs and RTC\_GPIOs.

## Revision History

Date	Version	Release notes
2023-2	v1.6	<ul style="list-style-type: none"> <li>Improved the content in the following sections:               <ul style="list-style-type: none"> <li>Section <a href="#">Product Overview</a></li> <li>Section <a href="#">2 Pins</a></li> <li>Section <a href="#">3.2.1 Power Management Unit (PMU)</a></li> <li>Section <a href="#">3.5.2 Serial Peripheral Interface (SPI)</a></li> <li>Section <a href="#">4.1 Absolute Maximum Ratings</a></li> <li>Section <a href="#">4.2 Recommended Power Supply Characteristics</a></li> <li>Section <a href="#">4.3 VDD_SPI Output Characteristics</a></li> <li>Section <a href="#">4.5 ADC Characteristics</a></li> </ul> </li> <li>Added <a href="#">Appendix A</a></li> <li>Updated the notes in Section <a href="#">1 ESP32-S3 Series Comparison</a> and Section <a href="#">5 Packaging</a></li> <li>Updated the effective measurement range in Table <a href="#">4-5 ADC Characteristics</a></li> <li>Updated the Bluetooth maximum transmit power</li> <li>Other minor updates</li> </ul>
2022-12	v1.5	<ul style="list-style-type: none"> <li>Removed the "External PA is supported" feature from Section <a href="#">Features</a></li> <li>Updated the ambient temperature for ESP32-S3FH4R2 from -40 ~ 105 °C to -40 ~ 85 °C</li> <li>Added two notes in Section <a href="#">5</a></li> </ul>
2022-11	v1.4	<ul style="list-style-type: none"> <li>Added the package information for ESP32-S3FH4R2 in Section <a href="#">5</a></li> <li>Added <a href="#">ESP32-S3 Series SoC Errata</a> in Section <a href="#">Related Documentation and Resources</a></li> <li>Other minor updates</li> </ul>
2022-09	v1.3	<ul style="list-style-type: none"> <li>Added a note about the maximum ambient temperature of R8 series chips to Table <a href="#">1-1</a> and Table <a href="#">4-2</a></li> <li>Added information about power-up glitches for some pins in Section <a href="#">2.2</a></li> <li>Added the information about VDD3P3 power pins to Table <a href="#">2.2</a> and Section <a href="#">2.5.2</a></li> <li>Updated section <a href="#">3.7.1</a></li> <li>Added the fourth note in Table <a href="#">2-1</a></li> <li>Updated the minimum and maximum values of Bluetooth LE RF transmit power in Section <a href="#">4.9.1</a></li> <li>Other minor updates</li> </ul>

Cont'd on next page



## Cont'd from previous page

Date	Version	Release notes
2022-07	v1.2	<ul style="list-style-type: none"> <li>• Updated description of ROM code printing in Section 2.6</li> <li>• Updated Figure <a href="#">ESP32-S3 Functional Block Diagram</a></li> <li>• Update Section 4.6</li> <li>• Deleted the hyperlinks in <a href="#">Application</a></li> </ul>
2022-04	v1.1	<ul style="list-style-type: none"> <li>• Synchronized eFuse size throughout</li> <li>• Updated pin description in Table 2-1</li> <li>• Updated SPI resistance in Table 4-3</li> <li>• Added information about chip ESP32-S3FH4R2</li> </ul>
2022-01	v1.0	<ul style="list-style-type: none"> <li>• Added wake-up sources for Deep-sleep mode</li> <li>• Added Table 2-12 for default configurations of VDD_SPI</li> <li>• Added ADC calibration results in Table 4-5</li> <li>• Added typical values when all peripherals and peripheral clocks are enabled to Table 4-7</li> <li>• Added more descriptions of modules/peripherals in Section 3</li> <li>• Updated Figure <a href="#">ESP32-S3 Functional Block Diagram</a></li> <li>• Updated JEDEC specification</li> <li>• Updated Wi-Fi RF data in Section 4.6</li> <li>• Updated temperature for ESP32-S3R8 and ESP32-S3R8V</li> <li>• Updated description of Deep-sleep mode in Table 4-8</li> <li>• Updated wording throughout</li> </ul>
2021-10-12	v0.6.1	Updated text description
2021-09-30	v0.6	<ul style="list-style-type: none"> <li>• Updated to chip revision 1 by swapping pin 53 and pin 54 (XTAL_P and XTAL_N)</li> <li>• Updated Figure <a href="#">ESP32-S3 Functional Block Diagram</a></li> <li>• Added CoreMark score in section Features</li> <li>• Updated Section 2.6</li> <li>• Added data for cumulative IO output current in Table 4-1</li> <li>• Added data for Modem-sleep current consumption in Table 4-7</li> <li>• Updated data in section 4.6, 4.8, and 4.9</li> <li>• Updated wording throughout</li> </ul>

Cont'd on next page

## Cont'd from previous page

Date	Version	Release notes
2021-07-19	v0.5.1	<ul style="list-style-type: none"><li>• Added "for chip revision 0" on cover, in footer and watermark to indicate that the current and previous versions of this datasheet are for chip version 0</li><li>• Corrected a few typos</li></ul>
2021-07-09	v0.5	Preliminary version



[www.espressif.com](http://www.espressif.com)

## Disclaimer and Copyright Notice

Information in this document, including URL references, is subject to change without notice.

ALL THIRD PARTY'S INFORMATION IN THIS DOCUMENT IS PROVIDED AS IS WITH NO WARRANTIES TO ITS AUTHENTICITY AND ACCURACY.

NO WARRANTY IS PROVIDED TO THIS DOCUMENT FOR ITS MERCHANTABILITY, NON-INFRINGEMENT, FITNESS FOR ANY PARTICULAR PURPOSE, NOR DOES ANY WARRANTY OTHERWISE ARISING OUT OF ANY PROPOSAL, SPECIFICATION OR SAMPLE.

All liability, including liability for infringement of any proprietary rights, relating to use of information in this document is disclaimed. No licenses express or implied, by estoppel or otherwise, to any intellectual property rights are granted herein.

The Wi-Fi Alliance Member logo is a trademark of the Wi-Fi Alliance. The Bluetooth logo is a registered trademark of Bluetooth SIG.

All trade names, trademarks and registered trademarks mentioned in this document are property of their respective owners, and are hereby acknowledged.

**Copyright © 2023 Espressif Systems (Shanghai) Co., Ltd. All rights reserved.**