

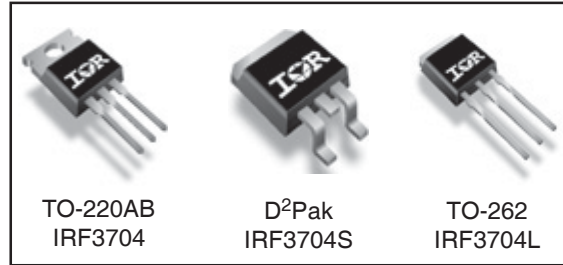
**Applications**

- High Frequency DC-DC Isolated Converters with Synchronous Rectification for Telecom and Industrial use
- High Frequency Buck Converters for Computer Processor Power
- Lead-Free

<b>V<sub>DSS</sub></b>	<b>R<sub>DS(on)</sub> max</b>	<b>I<sub>D</sub></b>
<b>20V</b>	<b>9.0mΩ</b>	<b>77A<sup>⑤</sup></b>

**Benefits**

- Ultra-Low Gate Impedance
- Very Low R<sub>DS(on)</sub>
- Fully Characterized Avalanche Voltage and Current



**Absolute Maximum Ratings**

Symbol	Parameter	Max.	Units
V <sub>DS</sub>	Drain-Source Voltage	20	V
V <sub>GS</sub>	Gate-to-Source Voltage	± 20	V
I <sub>D</sub> @ T <sub>C</sub> = 25°C	Continuous Drain Current, V <sub>GS</sub> @ 10V	77 <sup>⑤</sup>	A
I <sub>D</sub> @ T <sub>C</sub> = 70°C	Continuous Drain Current, V <sub>GS</sub> @ 10V	64	
I <sub>DM</sub>	Pulsed Drain Current <sup>①</sup>	308	
P <sub>D</sub> @ T <sub>C</sub> = 25°C	Maximum Power Dissipation <sup>③</sup>	87	W
P <sub>D</sub> @ T <sub>C</sub> = 70°C	Maximum Power Dissipation <sup>③</sup>	61	W
	Linear Derating Factor	0.59	mW/°C
T <sub>J</sub> , T <sub>STG</sub>	Junction and Storage Temperature Range	-55 to + 175	°C

**Thermal Resistance**

	Parameter	Typ.	Max.	Units
R <sub>θJC</sub>	Junction-to-Case	—	1.73	°C/W
R <sub>θCS</sub>	Case-to-Sink, Flat, Greased Surface <sup>④</sup>	0.50	—	
R <sub>θJA</sub>	Junction-to-Ambient <sup>④</sup>	—	62	
R <sub>θJA</sub>	Junction-to-Ambient (PCB mount)*	—	40	

\* When mounted on 1" square PCB (FR-4 or G-10 Material) .  
 For recommended footprint and soldering techniques refer to application note #AN-994

Notes ① through ④ are on page 10

# IRF3704/S/LPbF

International  
**IR** Rectifier

## Static @ T<sub>J</sub> = 25°C (unless otherwise specified)

	Parameter	Min.	Typ.	Max.	Units	Conditions
V <sub>(BR)DSS</sub>	Drain-to-Source Breakdown Voltage	20	—	—	V	V <sub>GS</sub> = 0V, I <sub>D</sub> = 250μA
ΔV <sub>(BR)DSS</sub> /ΔT <sub>J</sub>	Breakdown Voltage Temp. Coefficient	—	0.021	—	V/°C	Reference to 25°C, I <sub>D</sub> = 1mA
R <sub>DS(on)</sub>	Static Drain-to-Source On-Resistance	—	6.3	9.0	mΩ	V <sub>GS</sub> = 10V, I <sub>D</sub> = 15A ③
		—	9.8	13.5		V <sub>GS</sub> = 4.5V, I <sub>D</sub> = 12A ③
V <sub>GS(th)</sub>	Gate Threshold Voltage	1.0	—	3.0	V	V <sub>DS</sub> = V <sub>GS</sub> , I <sub>D</sub> = 250μA
I <sub>DSS</sub>	Drain-to-Source Leakage Current	—	—	20	μA	V <sub>DS</sub> = 16V, V <sub>GS</sub> = 0V
		—	—	100		V <sub>DS</sub> = 16V, V <sub>GS</sub> = 0V, T <sub>J</sub> = 125°C
I <sub>GSS</sub>	Gate-to-Source Forward Leakage	—	—	200	nA	V <sub>GS</sub> = 16V
	Gate-to-Source Reverse Leakage	—	—	-200		V <sub>GS</sub> = -16V

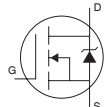
## Dynamic @ T<sub>J</sub> = 25°C (unless otherwise specified)

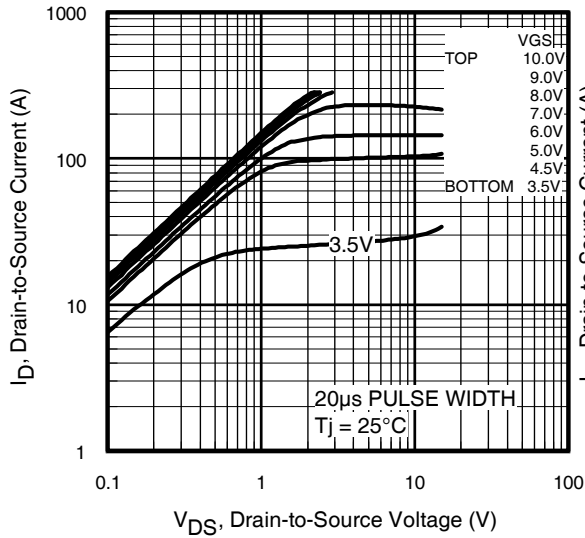
Symbol	Parameter	Min.	Typ.	Max.	Units	Conditions
g <sub>fs</sub>	Forward Transconductance	42	—	—	S	V <sub>DS</sub> = 10V, I <sub>D</sub> = 57A
Q <sub>g</sub>	Total Gate Charge	—	19	—	nC	I <sub>D</sub> = 28.4A
Q <sub>gs</sub>	Gate-to-Source Charge	—	8.1	—		V <sub>DS</sub> = 10V
Q <sub>gd</sub>	Gate-to-Drain ("Miller") Charge	—	6.4	—		V <sub>GS</sub> = 4.5V ③
Q <sub>oss</sub>	Output Gate Charge	—	16	24		V <sub>GS</sub> = 0V, V <sub>DS</sub> = 10V
t <sub>d(on)</sub>	Turn-On Delay Time	—	8.4	—	ns	V <sub>DD</sub> = 10V
t <sub>r</sub>	Rise Time	—	98	—		I <sub>D</sub> = 28.4A
t <sub>d(off)</sub>	Turn-Off Delay Time	—	12	—		R <sub>G</sub> = 1.8Ω
t <sub>f</sub>	Fall Time	—	5.0	—		V <sub>GS</sub> = 4.5V ③
C <sub>iss</sub>	Input Capacitance	—	1996	—	pF	V <sub>GS</sub> = 0V
C <sub>oss</sub>	Output Capacitance	—	1085	—		V <sub>DS</sub> = 10V
C <sub>rss</sub>	Reverse Transfer Capacitance	—	155	—		f = 1.0MHz

## Avalanche Characteristics

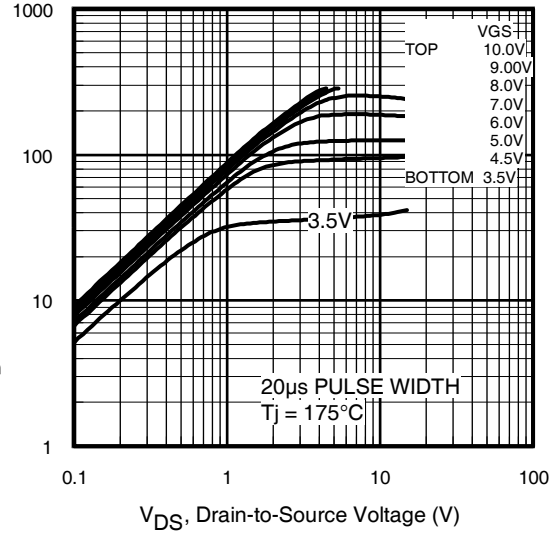
Symbol	Parameter	Typ.	Max.	Units
E <sub>AS</sub>	Single Pulse Avalanche Energy②	—	216	mJ
I <sub>AR</sub>	Avalanche Current①	—	71	A

## Diode Characteristics

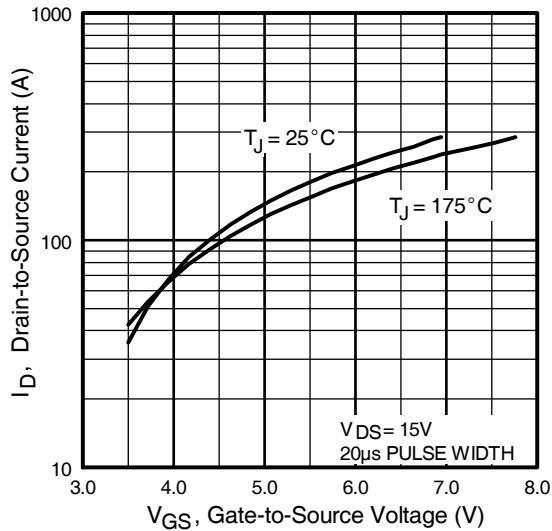
Symbol	Parameter	Min.	Typ.	Max.	Units	Conditions
I <sub>S</sub>	Continuous Source Current (Body Diode)	—	—	77⑤	A	MOSFET symbol showing the integral reverse p-n junction diode. 
I <sub>SM</sub>	Pulsed Source Current (Body Diode) ①	—	—	308		
V <sub>SD</sub>	Diode Forward Voltage	—	0.88	1.3	V	T <sub>J</sub> = 25°C, I <sub>S</sub> = 35.5A, V <sub>GS</sub> = 0V ③
		—	0.82	—		T <sub>J</sub> = 125°C, I <sub>S</sub> = 35.5A, V <sub>GS</sub> = 0V ③
t <sub>rr</sub>	Reverse Recovery Time	—	38	57	ns	T <sub>J</sub> = 25°C, I <sub>F</sub> = 35.5A, V <sub>R</sub> = 20V
Q <sub>rr</sub>	Reverse Recovery Charge	—	45	68	nC	di/dt = 100A/μs ③
t <sub>rr</sub>	Reverse Recovery Time	—	41	62	ns	T <sub>J</sub> = 125°C, I <sub>F</sub> = 35.5A, V <sub>R</sub> = 20V
Q <sub>rr</sub>	Reverse Recovery Charge	—	50	75	nC	di/dt = 100A/μs ③



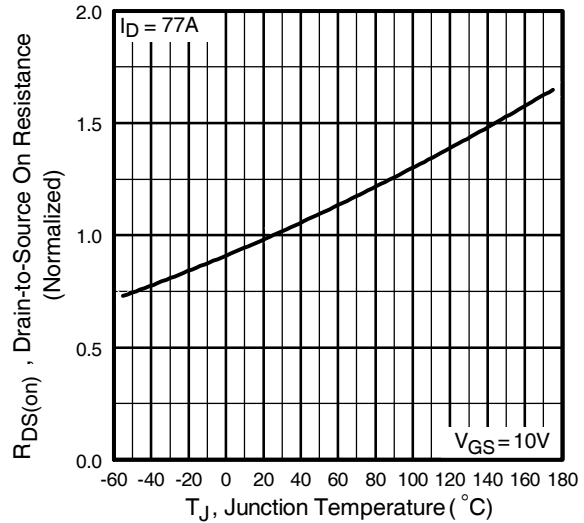
**Fig 1.** Typical Output Characteristics



**Fig 2.** Typical Output Characteristics

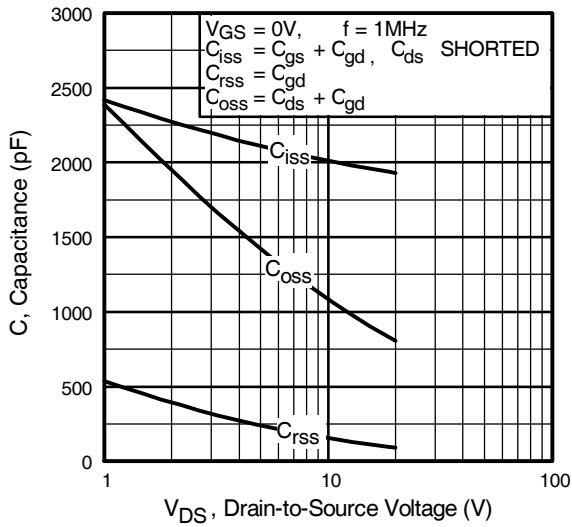


**Fig 3.** Typical Transfer Characteristics

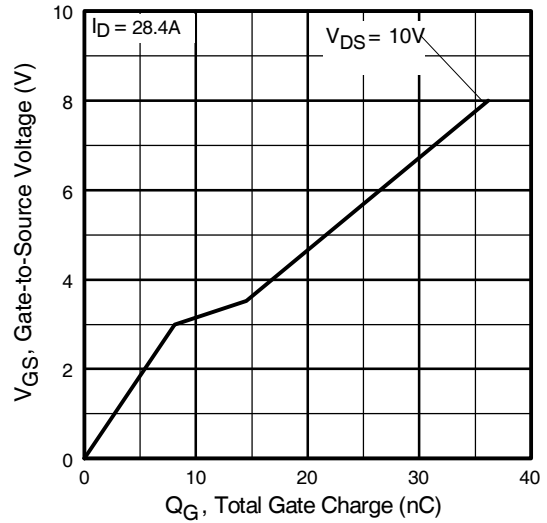


**Fig 4.** Normalized On-Resistance Vs. Temperature

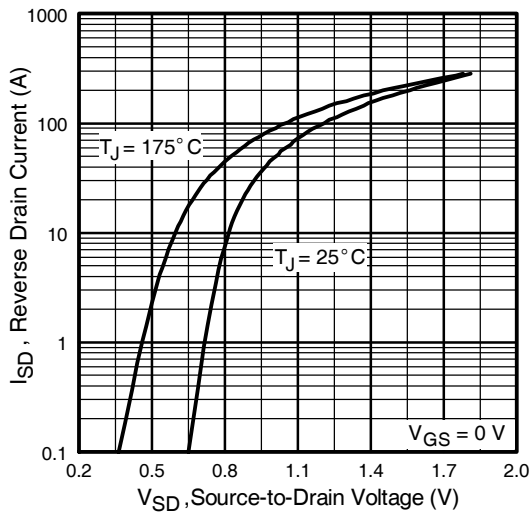
# IRF3704/S/LPbF



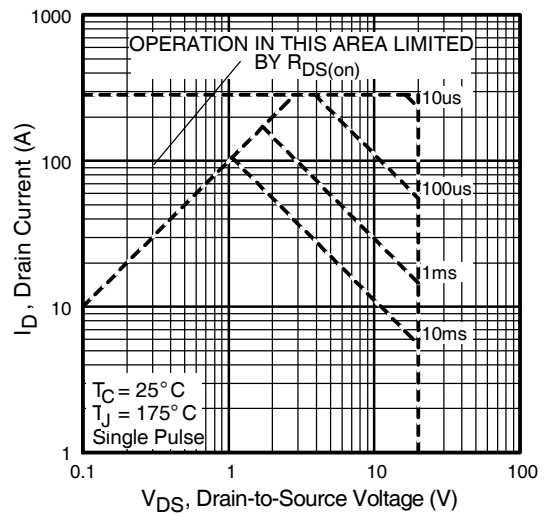
**Fig 5.** Typical Capacitance Vs. Drain-to-Source Voltage



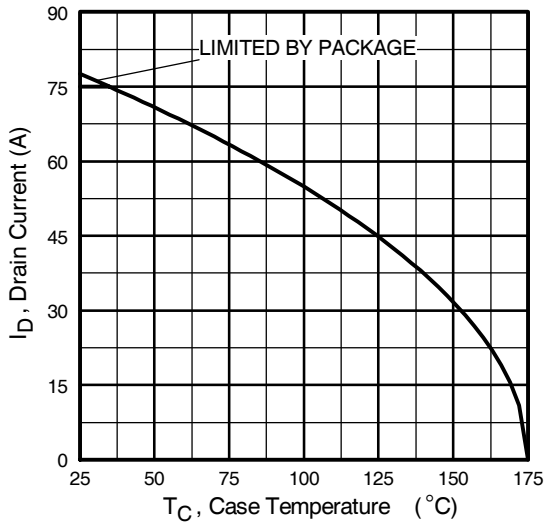
**Fig 6.** Typical Gate Charge Vs. Gate-to-Source Voltage



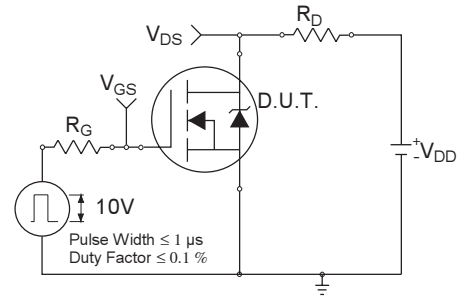
**Fig 7.** Typical Source-Drain Diode Forward Voltage



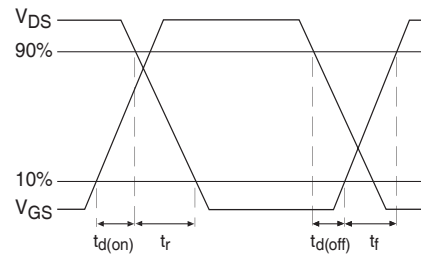
**Fig 8.** Maximum Safe Operating Area



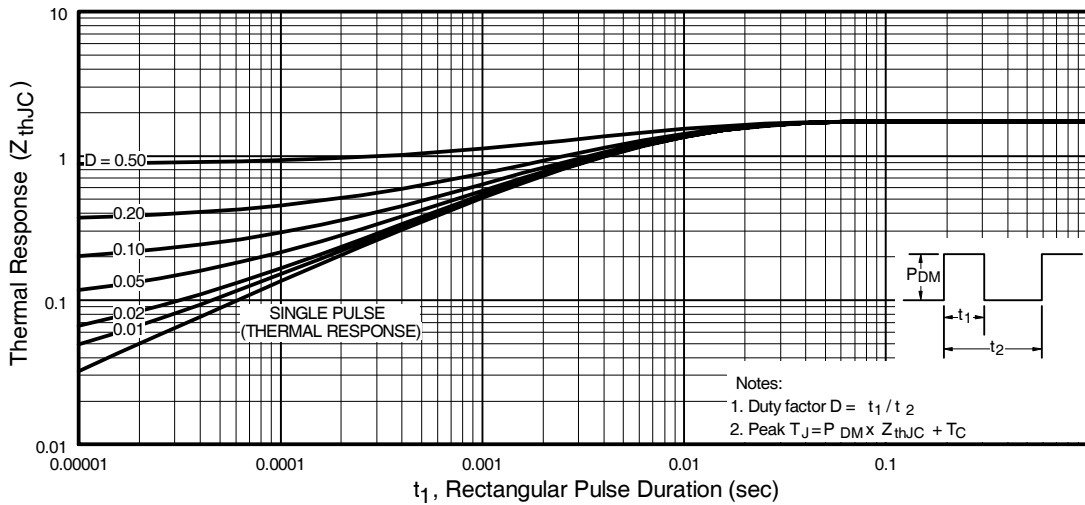
**Fig 9.** Maximum Drain Current Vs. Case Temperature



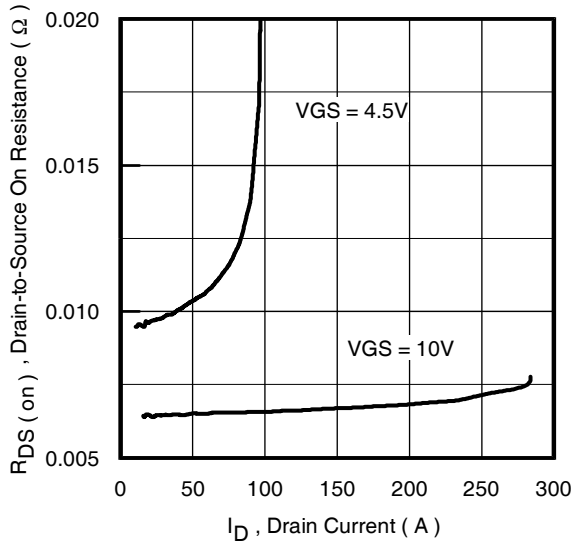
**Fig 10a.** Switching Time Test Circuit



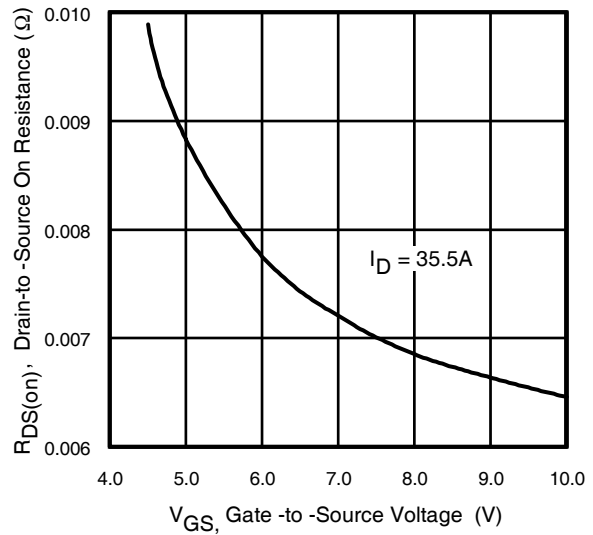
**Fig 10b.** Switching Time Waveforms



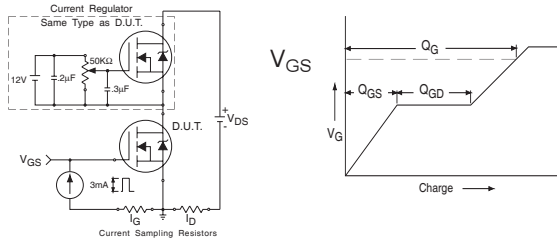
**Fig 11.** Maximum Effective Transient Thermal Impedance, Junction-to-Ambient



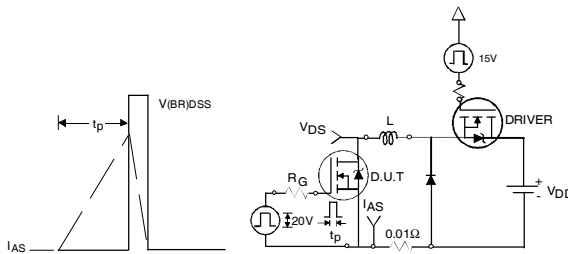
**Fig 12.** On-Resistance Vs. Drain Current



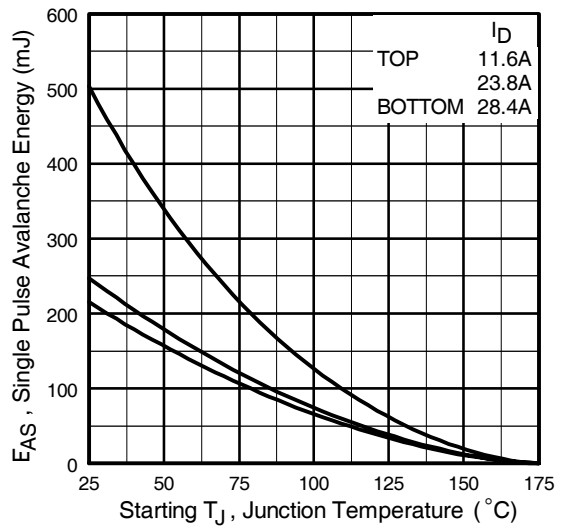
**Fig 13.** On-Resistance Vs. Gate Voltage



**Fig 14a&b.** Basic Gate Charge Test circuit and Waveforms



**Fig 15a&b.** Unclamped Inductive Test circuit and Waveforms



**Fig 15c.** Maximum Avalanche Energy Vs. Drain Current

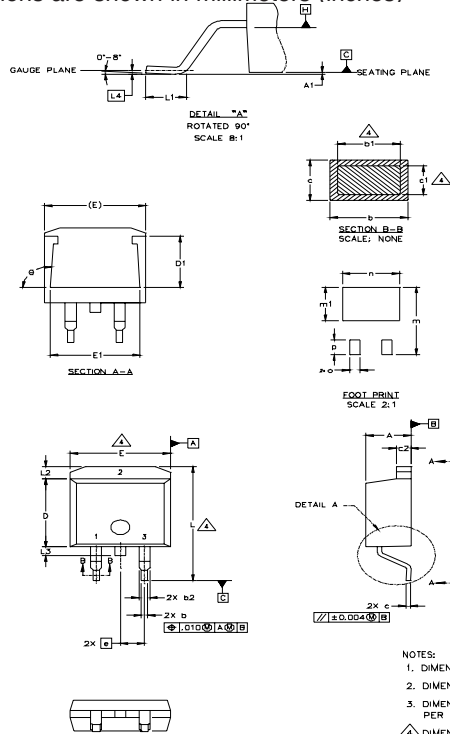


# IRF3704/S/LPbF

International  
**IR** Rectifier

## D<sup>2</sup>Pak Package Outline

Dimensions are shown in millimeters (inches)



SYMBOL	DIMENSIONS				NOTES
	MILLIMETERS		INCHES		
	MIN.	MAX.	MIN.	MAX.	
A	4.06	4.83	.160	.190	4
A1		0.127		.005	
b	0.51	0.99	.020	.039	
b1	0.51	0.89	.020	.035	
b2	1.14	1.40	.045	.055	4
c	0.43	0.63	.017	.025	
c1	0.38	0.74	.015	.029	3
c2	1.14	1.40	.045	.055	
D	8.51	9.65	.335	.380	3
D1	5.33		.210		
E	9.65	10.67	.380	.420	3
E1	6.22		.245		
e	2.54 BSC		.100 BSC		
L	14.61	15.88	.575	.625	
L1	1.78	2.79	.070	.110	
L2		1.65		.065	
L3	1.27	1.78	.050	.070	
L4	0.25 BSC		.010 BSC		
m	17.78		.700		
m1	8.89		.350		
n	11.43		.450		
o	2.08		.082		
p	3.81		.150		
θ	90°	93°	90°	93°	

### LEAD ASSIGNMENTS

HEXFET	IGBTs, CoPACK	DIODES
1.- GATE	1.- GATE	1.- ANODE *
2.- DRAIN	2.- COLLECTOR	2.- CATHODE
3.- SOURCE	3.- EMITTER	3.- ANODE

\* PART DEPENDENT.

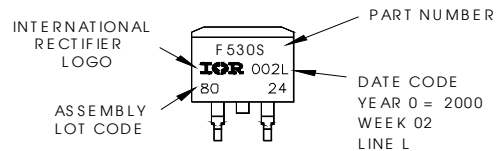
### NOTES:

1. DIMENSIONING AND TOLERANCING PER ASME Y14.5M-1994
2. DIMENSIONS ARE SHOWN IN MILLIMETERS [INCHES].
3. DIMENSION D & E DO NOT INCLUDE MOLD FLASH. MOLD FLASH SHALL NOT EXCEED 0.127 [ .005"] PER SIDE. THESE DIMENSIONS ARE MEASURED AT THE OUTMOST EXTREMES OF THE PLASTIC BODY.
4. DIMENSION b1 AND c1 APPLY TO BASE METAL ONLY.
5. CONTROLLING DIMENSION: INCH.

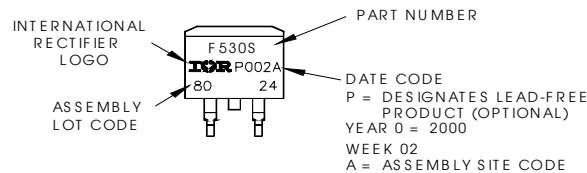
## D<sup>2</sup>Pak Part Marking Information (Lead-Free)

EXAMPLE: THIS IS AN IRF530S WITH  
LOT CODE 8024  
ASSEMBLED ON WW 02, 2000  
IN THE ASSEMBLY LINE "L"

Note: "P" in assembly line  
position indicates "Lead-Free"

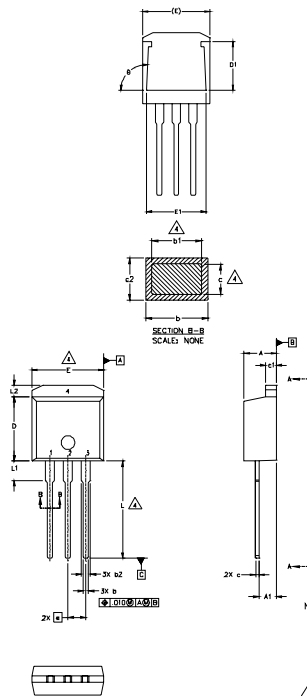


**OR**





## TO-262 Package Outline



SYMBOL	DIMENSIONS				NOTES
	MILLIMETERS		INCHES		
	MIN.	MAX.	MIN.	MAX.	
A	4.06	4.83	.160	.190	
A1	2.03	2.92	.080	.115	
b	0.51	0.99	.020	.039	
b1	0.51	0.89	.020	.035	4
b2	1.14	1.40	.045	.055	
c	0.38	0.63	.015	.025	4
c1	1.14	1.40	.045	.055	
c2	0.43	.063	.017	.029	
D	8.51	9.65	.335	.380	3
D1	5.33		.210		
E	9.65	10.67	.380	.420	3
E1	6.22		.245		
e	2.54 BSC		.100 BSC		
L	13.46	14.09	.530	.555	
L1	3.56	3.71	.140	.146	
L2		1.65		.065	

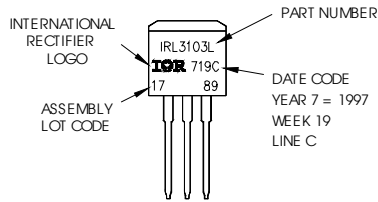
LEAD ASSIGNMENTS

- |            |              |
|------------|--------------|
|            | IGBT         |
| HEXFET     | 1- GATE      |
| 1.- GATE   | 2- COLLECTOR |
| 2.- DRAIN  | 3- EMITTER   |
| 3.- SOURCE |              |
| 4.- DRAIN  |              |

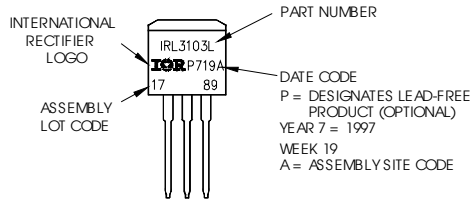
- NOTES:
- DIMENSIONING AND TOLERANCING PER ASME Y14.5M-1994
  - DIMENSIONS ARE SHOWN IN MILLIMETERS [INCHES].
  - DIMENSION D & E DO NOT INCLUDE MOLD FLASH. MOLD FLASH SHALL NOT EXCEED 0.127 [0.005"] PER SIDE. THESE DIMENSIONS ARE MEASURED AT THE OUTMOST EXTREMES OF THE PLASTIC BODY.
  - DIMENSION b1 AND c1 APPLY TO BASE METAL ONLY.
  - CONTROLLING DIMENSION: INCH.

## TO-262 Part Marking Information

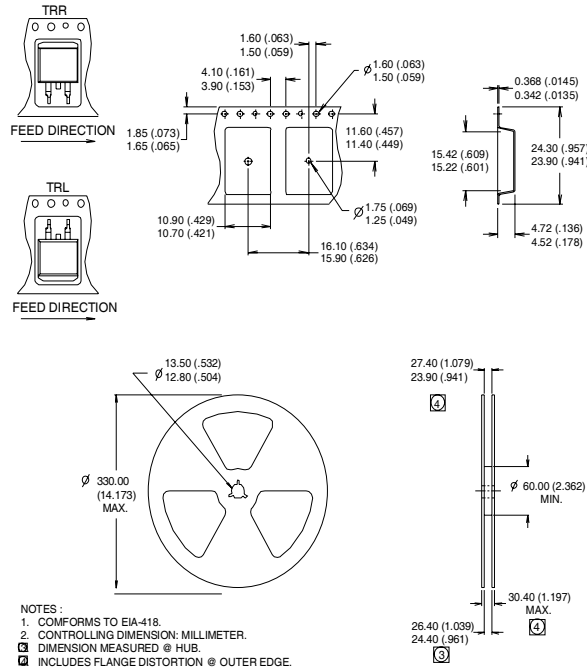
EXAMPLE: THIS IS AN IRL3103L  
 LOT CODE 1789  
 ASSEMBLED ON WW 19, 1997  
 IN THE ASSEMBLY LINE "C"  
 Note: "P" in assembly line  
 position indicates "Lead-Free"



OR



## D<sup>2</sup>Pak Tape & Reel Information



### Notes:

- ① Repetitive rating; pulse width limited by max. junction temperature.
- ② Starting  $T_J = 25^\circ\text{C}$ ,  $L = 0.5\text{ mH}$   
 $R_G = 25\Omega$ ,  $I_{AS} = 28.4\text{ A}$ .
- ③ Pulse width  $\leq 300\mu\text{s}$ ; duty cycle  $\leq 2\%$ .
- ④ This is only applied to TO-220AB package
- ⑤ Calculated continuous current based on maximum allowable junction temperature. Package limitation current is 75A.

Data and specifications subject to change without notice.

International  
**IR** Rectifier

**IR WORLD HEADQUARTERS:** 233 Kansas St., El Segundo, California 90245, USA Tel: (310) 252-7105  
TAC Fax: (310) 252-7903

Visit us at [www.irf.com](http://www.irf.com) for sales contact information.07/04

Note: For the most current drawings please refer to the IR website at:  
<http://www.irf.com/package/>