

# TPS7415, TPS7418, TPS7425, TPS7430, TPS7433 FAST-TRANSIENT-RESPONSE USING SMALL OUTPUT CAPACITOR 200-mA LOW-DROPOUT VOLTAGE REGULATORS

SLVS212 – DECEMBER 1999

- Fast Transient Response Using Small Output Capacitor (10  $\mu$ F)
- 200-mA Low-Dropout Voltage Regulator
- Available in 1.5-V, 1.8-V, 2.5-V, 3-V and 3.3-V
- Dropout Voltage Down to 170 mV at 200 mA (TPS7433)
- 3% Tolerance Over Specified Conditions
- 8-Pin SOIC Package
- Thermal Shutdown Protection

D PACKAGE  
(TOP VIEW)

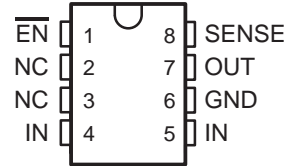

NC – No internal connection

## description

This device is designed to have a fast transient response and be stable with 1- $\mu$ F capacitors. This combination provides high performance at a reasonable cost.

Because the PMOS device behaves as a low-value resistor, the dropout voltage is very low (typically 170 mV at an output current of 200-mA for the TPS7433). This LDO family also features a sleep mode; applying a TTL high signal to  $\overline{\text{EN}}$  (enable) shuts down the regulator, reducing the quiescent current to less than 1  $\mu$ A at  $T_J = 25^\circ\text{C}$ .

The TPS74xx is offered in 1.5-V, 1.8-V, 2.5-V, 3-V, and 3.3-V. Output voltage tolerance is specified as a maximum of 3% over line, load, and temperature ranges. The TPS74xx family is available in 8 pin SOIC package.

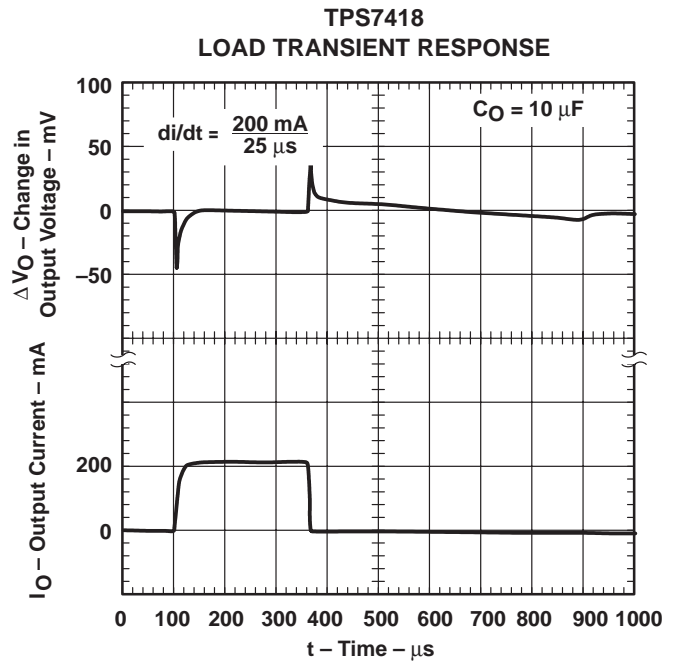
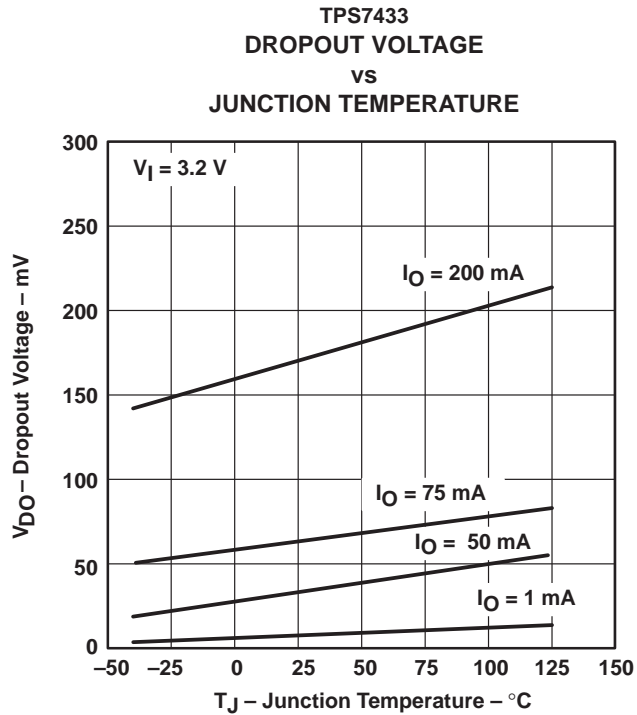

Please be aware that an important notice concerning availability, standard warranty, and use in critical applications of Texas Instruments semiconductor products and disclaimers thereto appears at the end of this data sheet.

PRODUCTION DATA information is current as of publication date. Products conform to specifications per the terms of Texas Instruments standard warranty. Production processing does not necessarily include testing of all parameters.

**TEXAS  
INSTRUMENTS**

POST OFFICE BOX 655303 • DALLAS, TEXAS 75265

Copyright © 1999, Texas Instruments Incorporated

# TPS7415, TPS7418, TPS7425, TPS7430, TPS7433 FAST-TRANSIENT-RESPONSE USING SMALL OUTPUT CAPACITOR 200-mA LOW-DROPOUT VOLTAGE REGULATORS

SLVS212 – DECEMBER 1999

## AVAILABLE OPTIONS

$T_J$	OUTPUT VOLTAGE (V)	PACKAGED DEVICES
	TYP	SOIC (D)
-40°C to 125°C	3.3	TPS7433D
	3	TPS7430D
	2.5	TPS7425D
	1.8	TPS7418D
	1.5	TPS7415D

The D package is available taped and reeled. Add an R suffix to the device type (e.g., TPS7433DR).

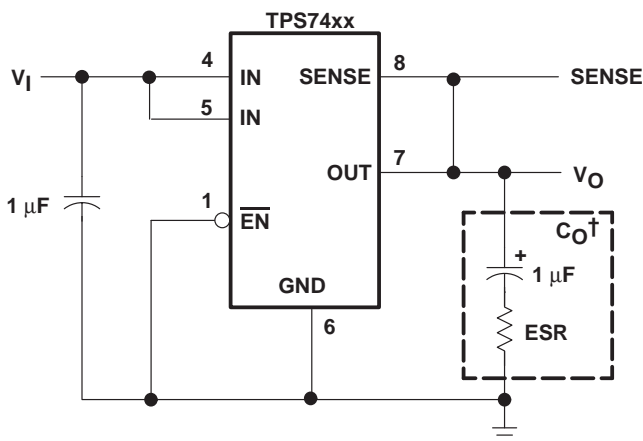

† See application information section for capacitor selection details.

Figure 1. Typical Application Configuration

## functional block diagram

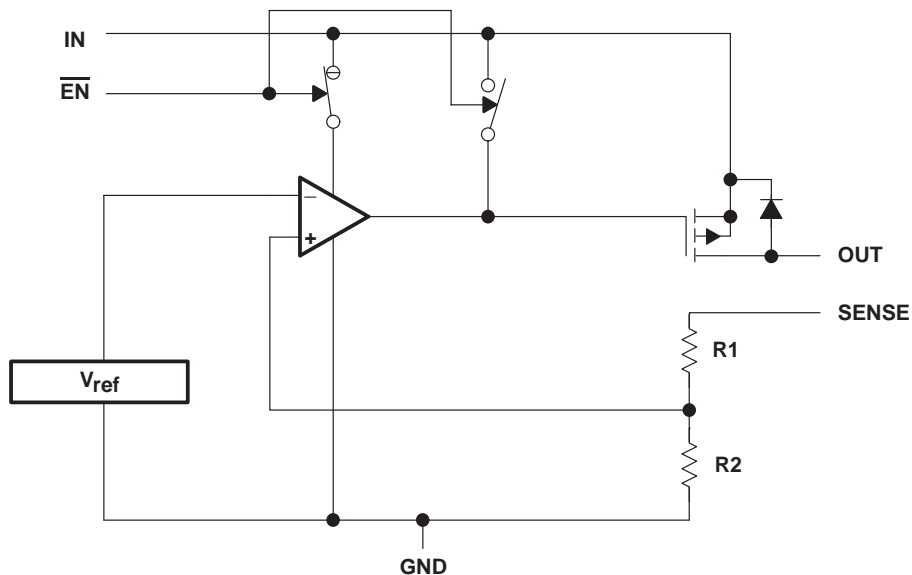

TPS7415, TPS7418, TPS7425, TPS7430, TPS7433  
**FAST-TRANSIENT-RESPONSE USING SMALL OUTPUT CAPACITOR**  
**200-mA LOW-DROPOUT VOLTAGE REGULATORS**

SLVS212 – DECEMBER 1999

**Terminal Functions**

TERMINAL NAME	NO.	I/O	DESCRIPTION
$\overline{\text{EN}}$	1	I	Enable input
GND	6		Regulator ground
IN	4, 5	I	Input voltage
NC	2, 3		Not connected
OUT	7	O	Regulated output voltage
SENSE	8	I	Sense

**absolute maximum ratings over operating free-air temperature range (unless otherwise noted)†**

Input voltage range‡, $V_I$	–0.3 V to 8 V
Voltage range at $\overline{\text{EN}}$	–0.3 V to $V_I + 0.3$ V
Peak output current	Internally limited
Continuous total power dissipation	See dissipation rating tables
Operating virtual junction temperature range, $T_J$	–40°C to 125°C
Storage temperature range, $T_{\text{stg}}$	–65°C to 150°C

† Stresses beyond those listed under “absolute maximum ratings” may cause permanent damage to the device. These are stress ratings only, and functional operation of the device at these or any other conditions beyond those indicated under “recommended operating conditions” is not implied. Exposure to absolute-maximum-rated conditions for extended periods may affect device reliability.

‡ All voltage values are with respect to network terminal ground.

**DISSIPATION RATING TABLE 1 – FREE-AIR TEMPERATURES**

PACKAGE	AIR FLOW (CFM)	$T_A < 25^\circ\text{C}$ POWER RATING	DERATING FACTOR ABOVE $T_A = 25^\circ\text{C}$	$T_A = 70^\circ\text{C}$ POWER RATING	$T_A = 85^\circ\text{C}$ POWER RATING
D	0	568 mW	5.68 mW/°C	312 mW	227 mW
	250	904 mW	9.04 mW/°C	497 mW	361 mW

**recommended operating conditions**

	MIN	MAX	UNIT
Input voltage, $V_I$ §	2.5	7	V
Output current, $I_O$ (see Note 1)	0	200	mA
Operating virtual junction temperature, $T_J$ (see Note 1)	–40	125	°C

§ To calculate the minimum input voltage for your maximum output current, use the following equation:  $V_{I(\text{min})} = V_{O(\text{max})} + V_{\text{DO}(\text{max load})}$ .

NOTE 1: Continuous current and operating junction temperature are limited by internal protection circuitry, but it is not recommended that the device operate under conditions beyond those specified in this table for extended periods of time.

**TPS7415, TPS7418, TPS7425, TPS7430, TPS7433**  
**FAST-TRANSIENT-RESPONSE USING SMALL OUTPUT CAPACITOR**  
**200-mA LOW-DROPOUT VOLTAGE REGULATORS**

SLVS212 – DECEMBER 1999

**electrical characteristics over recommended operating free-air temperature range,**  
 **$V_i = V_{O(typ)} + 1\text{ V}$ ,  $I_O = 1\text{ mA}$ ,  $\overline{EN} = 0\text{ V}$ ,  $C_O = 1\text{ }\mu\text{F}$  (unless otherwise noted)**

PARAMETER		TEST CONDITIONS	TEST CONDITIONS	MIN	TYP	MAX	UNIT
Output voltage (10 $\mu\text{A}$ to 200 mA load) (see Note 2)	TPS7415	$2.5\text{ V} < V_I < 7\text{ V}$	$T_J = 25^\circ\text{C}$		1.5		V
			$T_J = -40^\circ\text{C}$ to $125^\circ\text{C}$	1.455	1.545		
	TPS7418	$2.8\text{ V} < V_I < 7\text{ V}$	$T_J = 25^\circ\text{C}$		1.8		
			$T_J = -40^\circ\text{C}$ to $125^\circ\text{C}$	1.746	1.854		
	TPS7425	$3.5\text{ V} < V_I < 7\text{ V}$	$T_J = 25^\circ\text{C}$		2.5		
			$T_J = -40^\circ\text{C}$ to $125^\circ\text{C}$	2.425	2.575		
	TPS7430	$4.0\text{ V} < V_I < 7\text{ V}$	$T_J = 25^\circ\text{C}$		3.0		
			$T_J = -40^\circ\text{C}$ to $125^\circ\text{C}$	2.910	3.090		
	TPS7433	$4.3\text{ V} < V_I < 7\text{ V}$	$T_J = 25^\circ\text{C}$		3.3		
			$T_J = -40^\circ\text{C}$ to $125^\circ\text{C}$	3.201	3.399		
Quiescent current (GND current) (See Note 2)	$I_O = 1\text{ mA}$ , $\overline{EN} = 0\text{ V}$	$T_J = 25^\circ\text{C}$		80		$\mu\text{A}$	
		$T_J = -40^\circ\text{C}$ to $125^\circ\text{C}$		115			
	$I_O = 100\text{ mA}$ , $\overline{EN} = 0\text{ V}$	$T_J = 25^\circ\text{C}$		550		$\mu\text{A}$	
		$T_J = -40^\circ\text{C}$ to $125^\circ\text{C}$		850			
	$I_O = 200\text{ mA}$ , $\overline{EN} = 0\text{ V}$	$T_J = 25^\circ\text{C}$		1300		$\mu\text{A}$	
		$T_J = -40^\circ\text{C}$ to $125^\circ\text{C}$		1500			
Output voltage line regulation ( $\Delta V_O/V_O$ ) (see Notes 2 and 3)	$V_O + 1\text{ V} < V_I \leq 7\text{ V}$ ,	$T_J = 25^\circ\text{C}$		0.06		%/V	
Load regulation				5		mV	
Output noise voltage	$BW = 300\text{ Hz}$ to $50\text{ kHz}$ ,	$C_O = 1\text{ }\mu\text{F}$ ,	$T_J = 25^\circ\text{C}$		190		$\mu\text{V}_{\text{rms}}$
Output current Limit	$V_O = 0\text{ V}$			500	750		mA
Thermal shutdown junction temperature				150			$^\circ\text{C}$
Standby current	$2.5\text{ V} < V_I < 7\text{ V}$ ,	$T_J = 25^\circ\text{C}$	$\overline{EN} = V_I$		1		$\mu\text{A}$
			$\overline{EN} = V_I$		3		
High level enable input voltage				2			V
Low level enable input voltage					0.7		V
Input current (EN)	$\overline{EN} = 0\text{ V}$	$\overline{EN} = V_I$		-1	1		$\mu\text{A}$
				-1	1		
Power supply ripple rejection (see Note 2)	$f = 100\text{ Hz}$ ,	$C_O = 1\text{ }\mu\text{F}$ ,	$T_J = 25^\circ\text{C}$		55		dB
Dropout voltage (see Note 4)	TPS7430	$I_O = 200\text{ mA}$ ,	$T_J = 25^\circ\text{C}$		180		mV
			$T_J = -40^\circ\text{C}$ to $125^\circ\text{C}$		350		
	TPS7433	$I_O = 200\text{ mA}$ ,	$T_J = 25^\circ\text{C}$		170		
			$T_J = -40^\circ\text{C}$ to $125^\circ\text{C}$		315		

- NOTES: 2. Minimum IN operating voltage is  $2.5\text{ V}$  or  $V_{O(typ)} + 1\text{ V}$ , whichever is greater. Maximum IN voltage  $7\text{ V}$ .  
3. If  $V_O = 1.5\text{ V}$  then  $V_{imax} = 7\text{ V}$ ,  $V_{imin} = 2.5\text{ V}$ .  
4. IN voltage equals  $V_{O(Typ)} - 100\text{ mV}$ ; TPS7430 and TPS7433 dropout limited by input voltage range limitations (i.e., TPS7430 input voltage needs to drop to  $2.9\text{ V}$  for purpose of this test).

$$\text{Line Reg. (mV)} = (\%/V) \times \frac{V_O(V_{imax} - 2.5\text{ V})}{100} \times 1000$$

If  $V_O \geq 2.5\text{ V}$  then  $V_{imax} = 7\text{ V}$ ,  $V_{imin} = V_O + 1\text{ V}$ :

$$\text{Line Reg. (mV)} = (\%/V) \times \frac{V_O(V_{imax} - (V_O + 1\text{ V}))}{100} \times 1000$$



**TPS7415, TPS7418, TPS7425, TPS7430, TPS7433**  
**FAST-TRANSIENT-RESPONSE USING SMALL OUTPUT CAPACITOR**  
**200-mA LOW-DROPOUT VOLTAGE REGULATORS**

SLVS212 – DECEMBER 1999

**Table of Graphs**

			FIGURE
$V_O$	Output voltage	vs Output current	2, 3, 4
		vs Junction temperature	5, 6
	Ground current	vs Junction temperature	7, 8
	Power supply ripple rejection	vs Frequency	12
	Output noise	vs Frequency	9
$Z_o$	Output impedance	vs Frequency	10
$V_{DO}$	Dropout voltage	vs Junction temperature	11
		Line transient response	13, 15
	Load transient response		14, 16
	Output voltage	vs Time	17
	(Stability) Equivalent series resistance (ESR)	vs Output current	19

**TYPICAL CHARACTERISTICS**

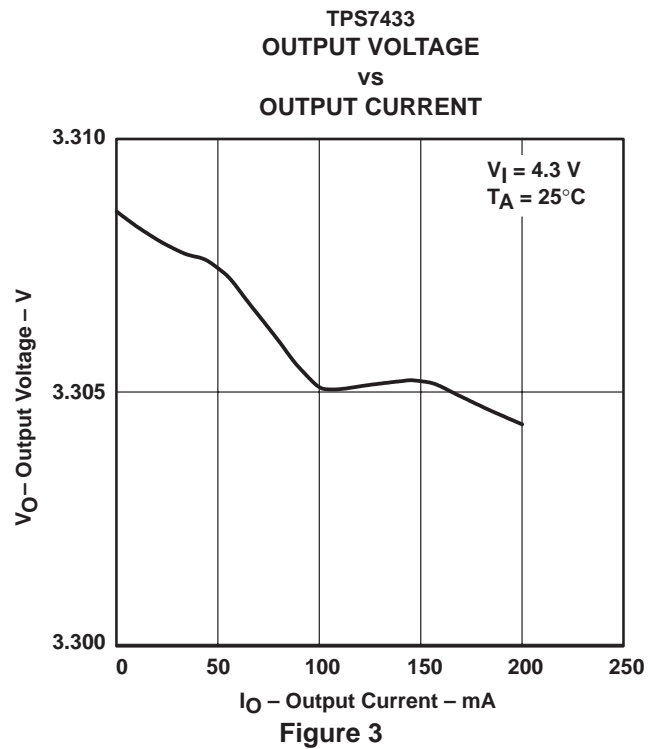
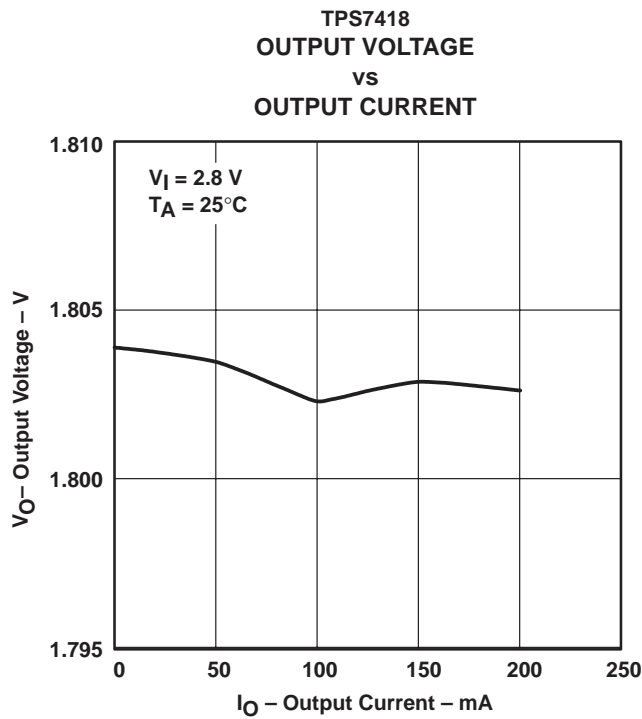

TPS7415, TPS7418, TPS7425, TPS7430, TPS7433  
 FAST-TRANSIENT-RESPONSE USING SMALL OUTPUT CAPACITOR  
 200-mA LOW-DROPOUT VOLTAGE REGULATORS

SLVS212 – DECEMBER 1999

TYPICAL CHARACTERISTICS

TPS7425  
 OUTPUT VOLTAGE  
 vs  
 OUTPUT CURRENT

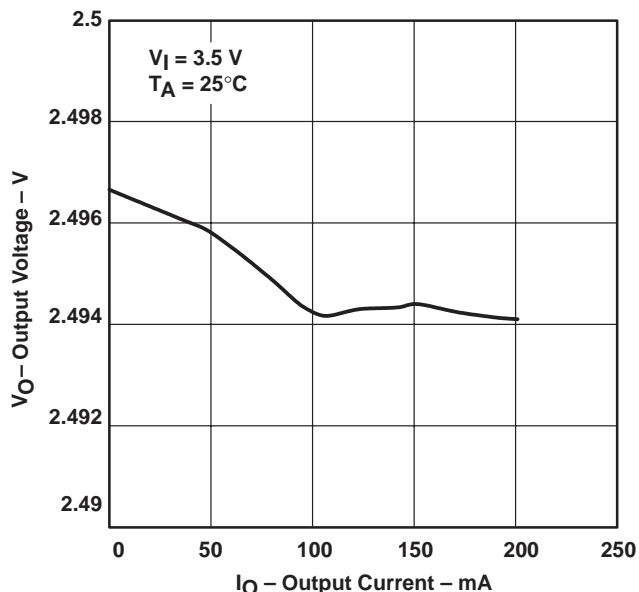

Figure 4

TPS7418  
 OUTPUT VOLTAGE  
 vs  
 JUNCTION TEMPERATURE

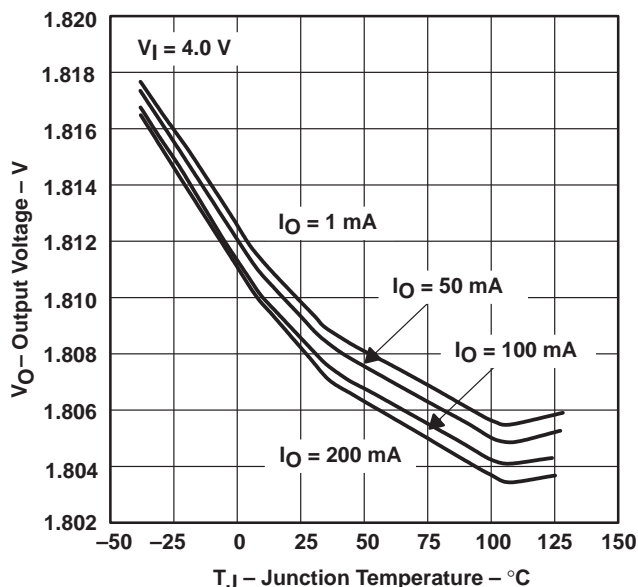

Figure 5

TPS7433  
 OUTPUT VOLTAGE  
 vs  
 JUNCTION TEMPERATURE

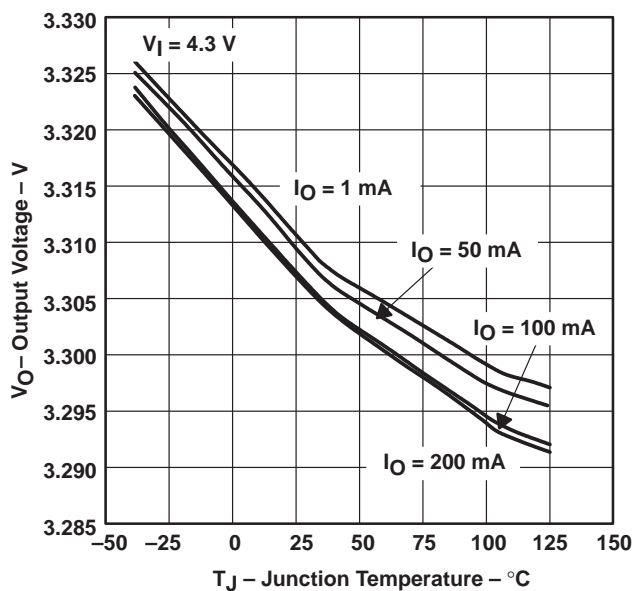

Figure 6

TPS7418  
 GROUND CURRENT  
 vs  
 JUNCTION TEMPERATURE

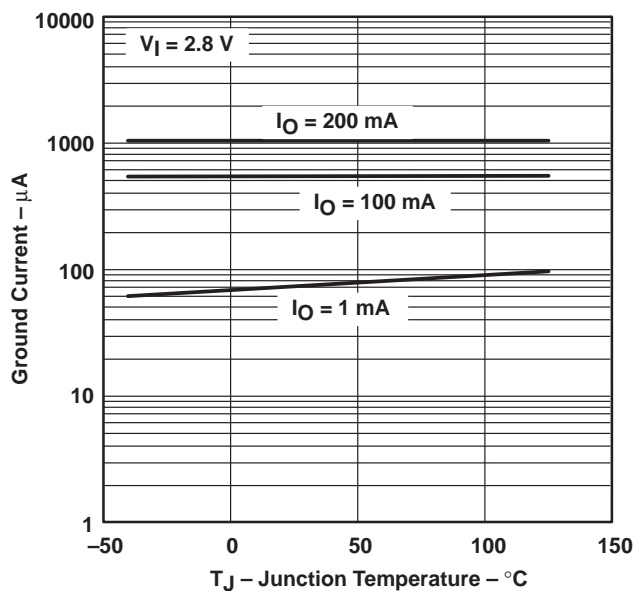

Figure 7



TPS7415, TPS7418, TPS7425, TPS7430, TPS7433  
 FAST-TRANSIENT-RESPONSE USING SMALL OUTPUT CAPACITOR  
 200-mA LOW-DROPOUT VOLTAGE REGULATORS

SLVS212 – DECEMBER 1999

TYPICAL CHARACTERISTICS

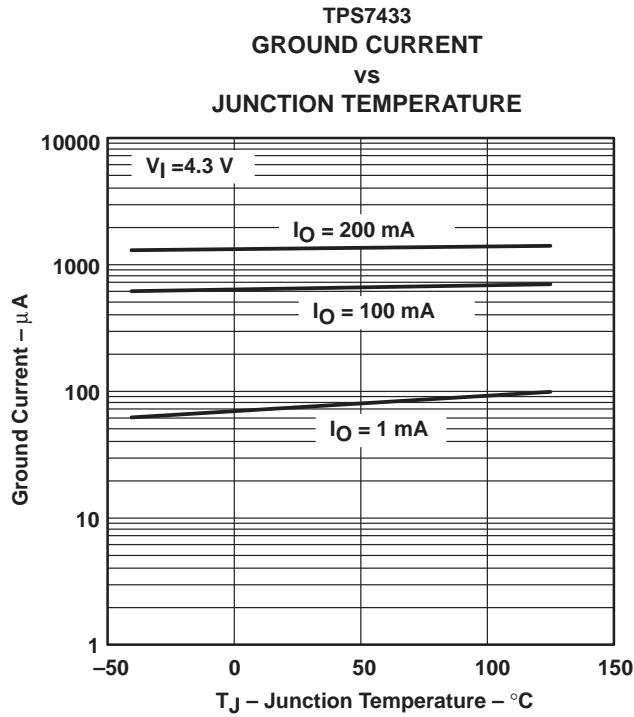

Figure 8

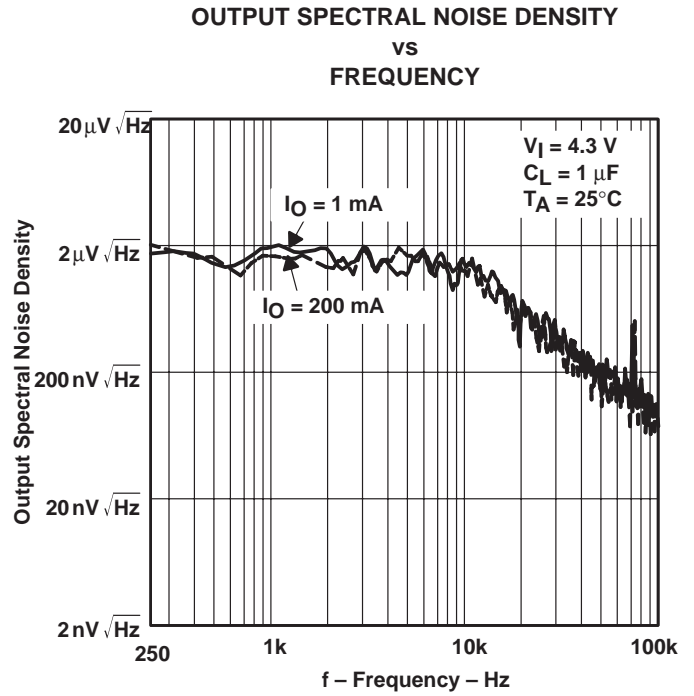

Figure 9

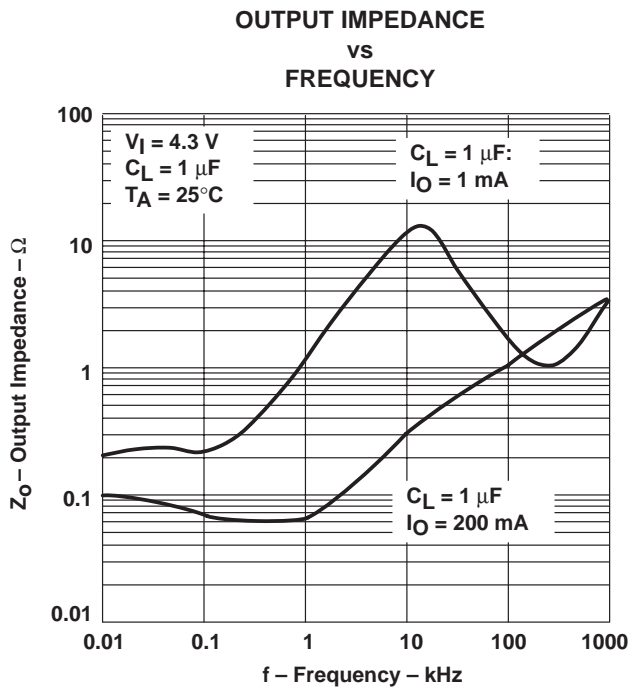

Figure 10

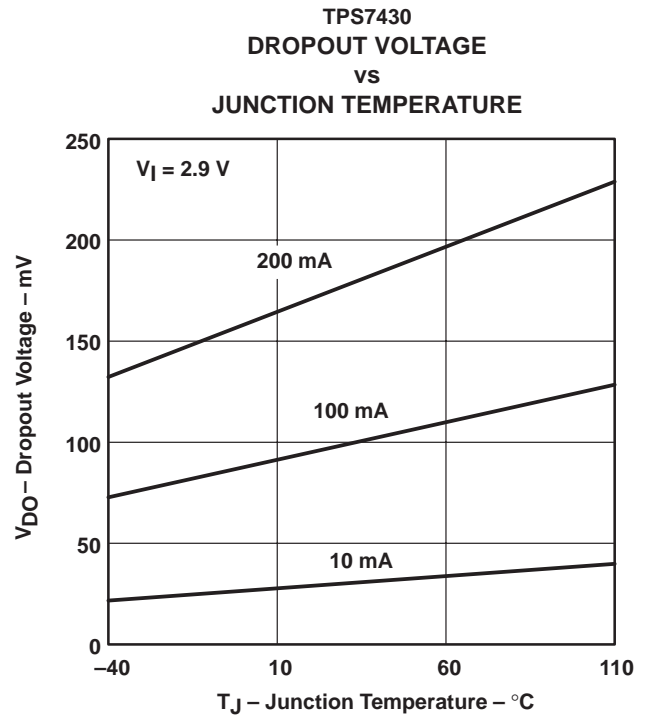

Figure 11

TPS7415, TPS7418, TPS7425, TPS7430, TPS7433  
 FAST-TRANSIENT-RESPONSE USING SMALL OUTPUT CAPACITOR  
 200-mA LOW-DROPOUT VOLTAGE REGULATORS

SLVS212 – DECEMBER 1999

TYPICAL CHARACTERISTICS

RIPPLE REJECTION  
 vs  
 FREQUENCY

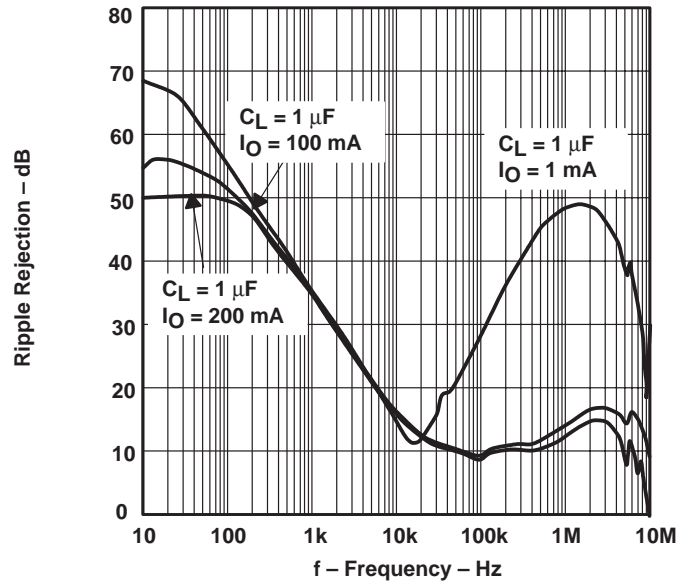

Figure 12

TPS7418  
 LINE TRANSIENT RESPONSE

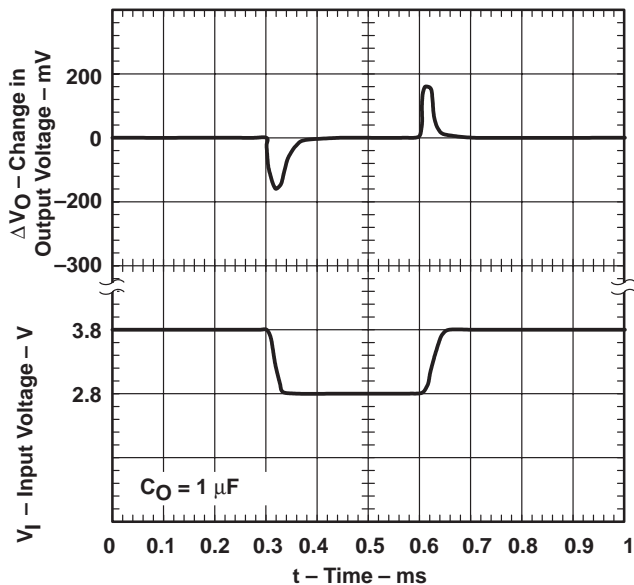

Figure 13

TPS7418  
 LOAD TRANSIENT RESPONSE

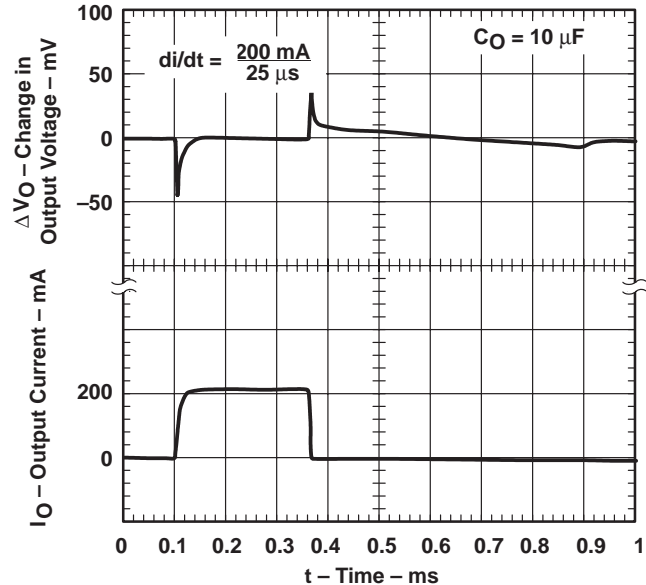

Figure 14





TYPICAL CHARACTERISTICS

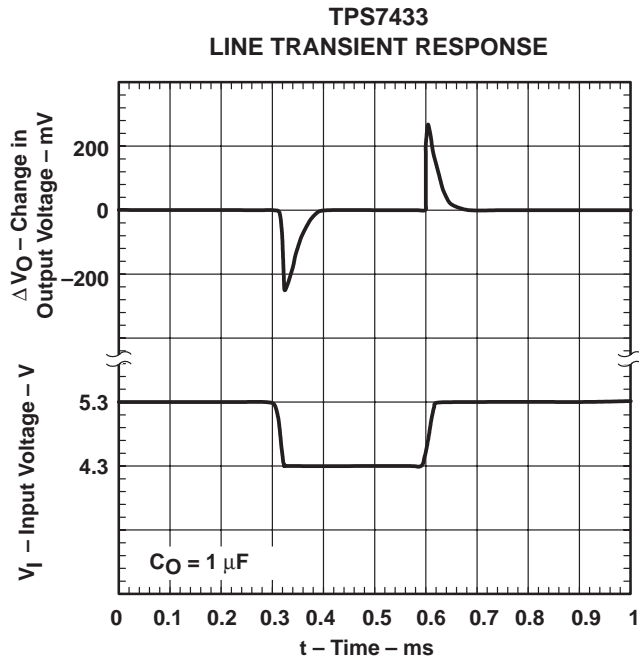

Figure 15

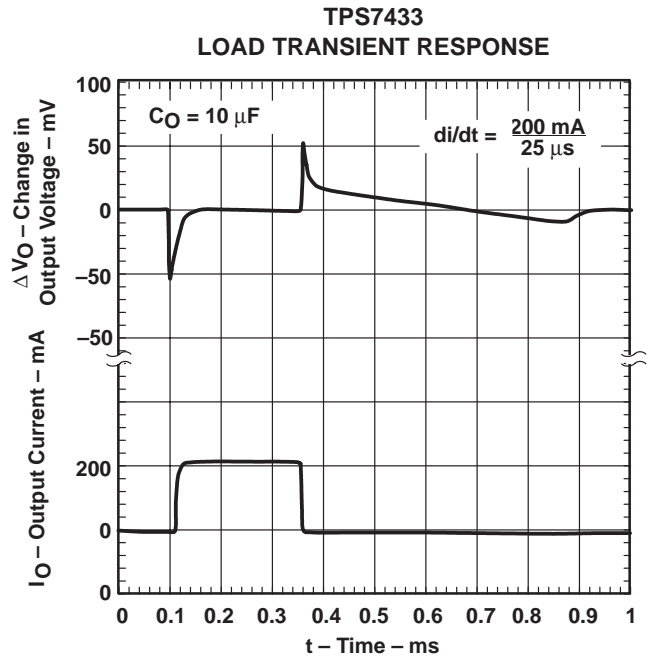

Figure 16

TPS7433  
 OUTPUT VOLTAGE  
 vs  
 TIME (AT STARTUP)

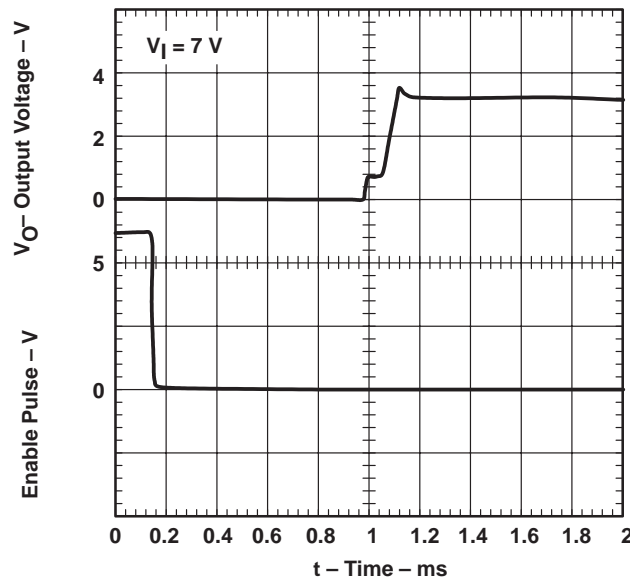

Figure 17

TPS7415, TPS7418, TPS7425, TPS7430, TPS7433  
 FAST-TRANSIENT-RESPONSE USING SMALL OUTPUT CAPACITOR  
 200-mA LOW-DROPOUT VOLTAGE REGULATORS

SLVS212 – DECEMBER 1999

TYPICAL CHARACTERISTICS

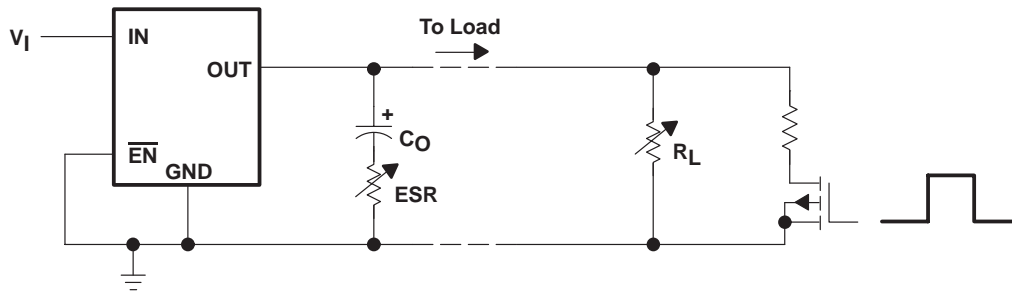

Figure 18. Test Circuit for Typical Regions of Stability (Figure 19)

TYPICAL REGIONS OF STABILITY  
 EQUIVALENT SERIES RESISTANCE (ESR)<sup>†</sup>  
 vs  
 OUTPUT CURRENT

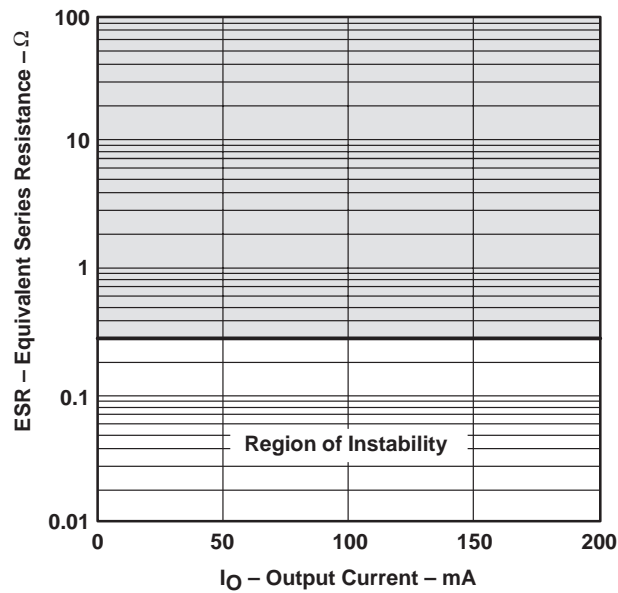

Figure 19

<sup>†</sup> ESR refers to the total series resistance, including the ESR of the capacitor, any series resistance added externally, and PWB trace resistance to C<sub>O</sub>.

## APPLICATION INFORMATION

The TPS74xx family includes five voltage regulators (1.5 V, 1.8 V, 2.5 V, 3 V, and 3.3 V).

### minimum load requirements

The TPS74xx family is stable even at zero load; no minimum load is required for operation.

### SENSE terminal connection

The SENSE terminal must be connected to the regulator output for proper functioning of the regulator. Normally, this connection should be as short as possible; however, the connection can be made near a critical circuit (remote sense) to improve performance at that point. Internally, SENSE connects to a high-impedance wide-bandwidth amplifier through a resistor-divider network and noise pickup feeds through to the regulator output. Routing the SENSE connection to minimize/avoid noise pickup is essential. Adding an RC network between SENSE and OUT to filter noise is not recommended because it can cause the regulator to oscillate.

### external capacitor requirements

An input capacitor is not usually required; however, a ceramic bypass capacitor (1  $\mu\text{F}$  or larger) improves load transient response and noise rejection if the TPS74xx is located more than a few inches from the power supply. A higher-capacitance electrolytic capacitor may be necessary if large (hundreds of milliamps) load transients with fast rise times are anticipated.

Like all low dropout regulators, the TPS74xx requires an output capacitor connected between OUT and GND to stabilize the internal control loop. The minimum recommended capacitance value is 1  $\mu\text{F}$  and the ESR (equivalent series resistance) must be at least 300 m $\Omega$ . Solid tantalum electrolytic and aluminum electrolytic are all suitable, provided they meet the requirements described previously.

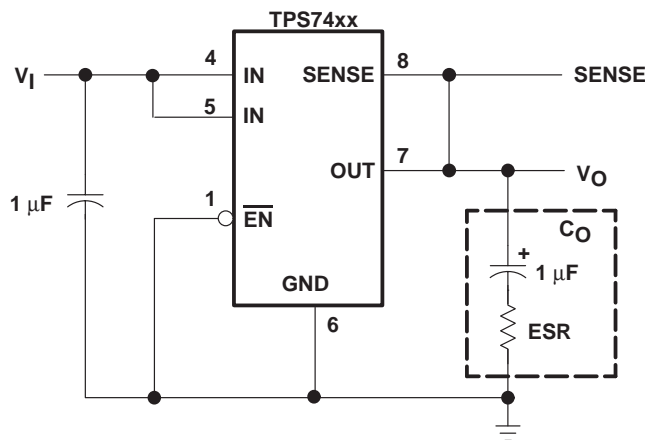

**Figure 20. Typical Application Circuit**

### regulator protection

The TPS74xx PMOS-pass transistor has a built-in back diode that conducts reverse currents when the input voltage drops below the output voltage (e.g., during power down). Current is conducted from the output to the input and is not internally limited. When extended reverse voltage is anticipated, external limiting may be appropriate.

# TPS7415, TPS7418, TPS7425, TPS7430, TPS7433 FAST-TRANSIENT-RESPONSE USING SMALL OUTPUT CAPACITOR 200-mA LOW-DROPOUT VOLTAGE REGULATORS

SLVS212 – DECEMBER 1999

---

## APPLICATION INFORMATION

### regulator protection (continued)

The TPS74xx also features internal current limiting and thermal protection. During normal operation, the TPS74xx limits output current to approximately 500 mA. When current limiting engages, the output voltage scales back linearly until the overcurrent condition ends. While current limiting is designed to prevent gross device failure, care should be taken not to exceed the power dissipation ratings of the package. If the temperature of the device exceeds 150°C(typ), thermal-protection circuitry shuts it down. Once the device has cooled below 130°C (typ), regulator operation resumes.

### power dissipation and junction temperature

Specified regulator operation is assured to a junction temperature of 125°C; the maximum junction temperature should be restricted to 125°C under normal operating conditions. This restriction limits the power dissipation the regulator can handle in any given application. To ensure the junction temperature is within acceptable limits, calculate the maximum allowable dissipation,  $P_{D(max)}$ , and the actual dissipation,  $P_D$ , which must be less than or equal to  $P_{D(max)}$ .

The maximum-power-dissipation limit is determined using the following equation:

$$P_{D(max)} = \frac{T_{Jmax} - T_A}{R_{\theta JA}}$$

Where

$T_{Jmax}$  is the maximum allowable junction temperature.

$R_{\theta JA}$  is the thermal resistance junction-to-ambient for the package, i.e., 172°C/W for the 8-terminal SOIC.

$T_A$  is the ambient temperature.

The regulator dissipation is calculated using:

$$P_D = (V_I - V_O) \times I_O$$

Power dissipation resulting from quiescent current is negligible. Excessive power dissipation will trigger the thermal protection circuit.

**PACKAGING INFORMATION**

Orderable Device	Status (1)	Package Type	Package Drawing	Pins	Package Qty	Eco Plan (2)	Lead finish/ Ball material (6)	MSL Peak Temp (3)	Op Temp (°C)	Device Marking (4/5)	Samples
TPS7415D	ACTIVE	SOIC	D	8	75	RoHS & Green	NIPDAU	Level-1-260C-UNLIM	-40 to 125	7415	<a href="#">Samples</a>
TPS7418D	ACTIVE	SOIC	D	8	75	RoHS & Green	NIPDAU	Level-1-260C-UNLIM	-40 to 125	7418	<a href="#">Samples</a>
TPS7418DG4	ACTIVE	SOIC	D	8	75	RoHS & Green	NIPDAU	Level-1-260C-UNLIM	-40 to 125	7418	<a href="#">Samples</a>
TPS7425D	ACTIVE	SOIC	D	8	75	RoHS & Green	NIPDAU	Level-1-260C-UNLIM	-40 to 125	7425	<a href="#">Samples</a>
TPS7430D	ACTIVE	SOIC	D	8	75	RoHS & Green	NIPDAU	Level-1-260C-UNLIM	-40 to 125	7430	<a href="#">Samples</a>
TPS7433D	ACTIVE	SOIC	D	8	75	RoHS & Green	NIPDAU	Level-1-260C-UNLIM	-40 to 125	7433	<a href="#">Samples</a>
TPS7433DR	ACTIVE	SOIC	D	8	2500	RoHS & Green	NIPDAU	Level-1-260C-UNLIM	-40 to 125	7433	<a href="#">Samples</a>

(1) The marketing status values are defined as follows:

**ACTIVE:** Product device recommended for new designs.

**LIFEBUY:** TI has announced that the device will be discontinued, and a lifetime-buy period is in effect.

**NRND:** Not recommended for new designs. Device is in production to support existing customers, but TI does not recommend using this part in a new design.

**PREVIEW:** Device has been announced but is not in production. Samples may or may not be available.

**OBSOLETE:** TI has discontinued the production of the device.

(2) **RoHS:** TI defines "RoHS" to mean semiconductor products that are compliant with the current EU RoHS requirements for all 10 RoHS substances, including the requirement that RoHS substance do not exceed 0.1% by weight in homogeneous materials. Where designed to be soldered at high temperatures, "RoHS" products are suitable for use in specified lead-free processes. TI may reference these types of products as "Pb-Free".

**RoHS Exempt:** TI defines "RoHS Exempt" to mean products that contain lead but are compliant with EU RoHS pursuant to a specific EU RoHS exemption.

**Green:** TI defines "Green" to mean the content of Chlorine (Cl) and Bromine (Br) based flame retardants meet JS709B low halogen requirements of <=1000ppm threshold. Antimony trioxide based flame retardants must also meet the <=1000ppm threshold requirement.

(3) MSL, Peak Temp. - The Moisture Sensitivity Level rating according to the JEDEC industry standard classifications, and peak solder temperature.

(4) There may be additional marking, which relates to the logo, the lot trace code information, or the environmental category on the device.

(5) Multiple Device Markings will be inside parentheses. Only one Device Marking contained in parentheses and separated by a "~" will appear on a device. If a line is indented then it is a continuation of the previous line and the two combined represent the entire Device Marking for that device.

<sup>(6)</sup> Lead finish/Ball material - Orderable Devices may have multiple material finish options. Finish options are separated by a vertical ruled line. Lead finish/Ball material values may wrap to two lines if the finish value exceeds the maximum column width.

**Important Information and Disclaimer:**The information provided on this page represents TI's knowledge and belief as of the date that it is provided. TI bases its knowledge and belief on information provided by third parties, and makes no representation or warranty as to the accuracy of such information. Efforts are underway to better integrate information from third parties. TI has taken and continues to take reasonable steps to provide representative and accurate information but may not have conducted destructive testing or chemical analysis on incoming materials and chemicals. TI and TI suppliers consider certain information to be proprietary, and thus CAS numbers and other limited information may not be available for release.

In no event shall TI's liability arising out of such information exceed the total purchase price of the TI part(s) at issue in this document sold by TI to Customer on an annual basis.

**TAPE AND REEL INFORMATION**

**QUADRANT ASSIGNMENTS FOR PIN 1 ORIENTATION IN TAPE**

\*All dimensions are nominal

Device	Package Type	Package Drawing	Pins	SPQ	Reel Diameter (mm)	Reel Width W1 (mm)	A0 (mm)	B0 (mm)	K0 (mm)	P1 (mm)	W (mm)	Pin1 Quadrant
TPS7433DR	SOIC	D	8	2500	330.0	12.4	6.4	5.2	2.1	8.0	12.0	Q1

**TAPE AND REEL BOX DIMENSIONS**

\*All dimensions are nominal

Device	Package Type	Package Drawing	Pins	SPQ	Length (mm)	Width (mm)	Height (mm)
TPS7433DR	SOIC	D	8	2500	350.0	350.0	43.0



**TUBE**

\*All dimensions are nominal

Device	Package Name	Package Type	Pins	SPQ	L (mm)	W (mm)	T (μm)	B (mm)
TPS7415D	D	SOIC	8	75	505.46	6.76	3810	4
TPS7418D	D	SOIC	8	75	505.46	6.76	3810	4
TPS7418DG4	D	SOIC	8	75	505.46	6.76	3810	4
TPS7425D	D	SOIC	8	75	505.46	6.76	3810	4
TPS7430D	D	SOIC	8	75	505.46	6.76	3810	4
TPS7433D	D	SOIC	8	75	505.46	6.76	3810	4



D0008A

# PACKAGE OUTLINE

SOIC - 1.75 mm max height

SMALL OUTLINE INTEGRATED CIRCUIT



## NOTES:

1. Linear dimensions are in inches [millimeters]. Dimensions in parenthesis are for reference only. Controlling dimensions are in inches. Dimensioning and tolerancing per ASME Y14.5M.
2. This drawing is subject to change without notice.
3. This dimension does not include mold flash, protrusions, or gate burrs. Mold flash, protrusions, or gate burrs shall not exceed  $.006$  [0.15] per side.
4. This dimension does not include interlead flash.
5. Reference JEDEC registration MS-012, variation AA.

# EXAMPLE BOARD LAYOUT

D0008A

SOIC - 1.75 mm max height

SMALL OUTLINE INTEGRATED CIRCUIT



LAND PATTERN EXAMPLE  
EXPOSED METAL SHOWN  
SCALE:8X



SOLDER MASK DETAILS

4214825/C 02/2019

NOTES: (continued)

- 6. Publication IPC-7351 may have alternate designs.
- 7. Solder mask tolerances between and around signal pads can vary based on board fabrication site.

# EXAMPLE STENCIL DESIGN

D0008A

SOIC - 1.75 mm max height

SMALL OUTLINE INTEGRATED CIRCUIT



SOLDER PASTE EXAMPLE  
BASED ON .005 INCH [0.125 MM] THICK STENCIL  
SCALE:8X

4214825/C 02/2019

NOTES: (continued)

8. Laser cutting apertures with trapezoidal walls and rounded corners may offer better paste release. IPC-7525 may have alternate design recommendations.
9. Board assembly site may have different recommendations for stencil design.

## IMPORTANT NOTICE AND DISCLAIMER

TI PROVIDES TECHNICAL AND RELIABILITY DATA (INCLUDING DATA SHEETS), DESIGN RESOURCES (INCLUDING REFERENCE DESIGNS), APPLICATION OR OTHER DESIGN ADVICE, WEB TOOLS, SAFETY INFORMATION, AND OTHER RESOURCES "AS IS" AND WITH ALL FAULTS, AND DISCLAIMS ALL WARRANTIES, EXPRESS AND IMPLIED, INCLUDING WITHOUT LIMITATION ANY IMPLIED WARRANTIES OF MERCHANTABILITY, FITNESS FOR A PARTICULAR PURPOSE OR NON-INFRINGEMENT OF THIRD PARTY INTELLECTUAL PROPERTY RIGHTS.

These resources are intended for skilled developers designing with TI products. You are solely responsible for (1) selecting the appropriate TI products for your application, (2) designing, validating and testing your application, and (3) ensuring your application meets applicable standards, and any other safety, security, regulatory or other requirements.

These resources are subject to change without notice. TI grants you permission to use these resources only for development of an application that uses the TI products described in the resource. Other reproduction and display of these resources is prohibited. No license is granted to any other TI intellectual property right or to any third party intellectual property right. TI disclaims responsibility for, and you will fully indemnify TI and its representatives against, any claims, damages, costs, losses, and liabilities arising out of your use of these resources.

TI's products are provided subject to [TI's Terms of Sale](#) or other applicable terms available either on [ti.com](http://ti.com) or provided in conjunction with such TI products. TI's provision of these resources does not expand or otherwise alter TI's applicable warranties or warranty disclaimers for TI products.

TI objects to and rejects any additional or different terms you may have proposed.

Mailing Address: Texas Instruments, Post Office Box 655303, Dallas, Texas 75265  
Copyright © 2022, Texas Instruments Incorporated