

Optocoupler, Photodarlington Output, High Gain, Single/Quad Channel, Half Pitch Mini-Flat Package

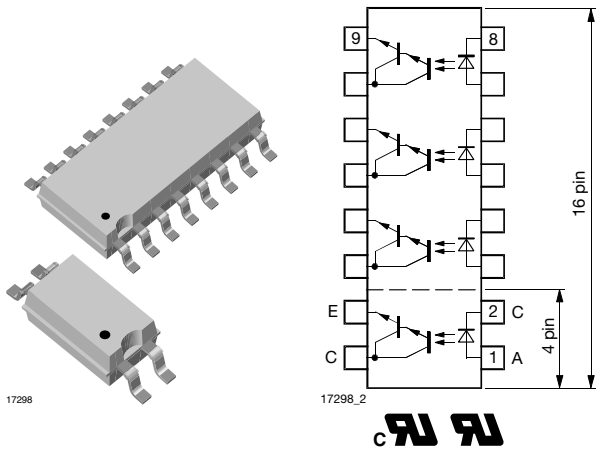

FEATURES

- Low profile package (half pitch)
- AC isolation test voltage 3750 V_{RMS}
- Low coupling capacitance of typical 0.3 pF
- Low temperature coefficient of CTR
- Wide ambient temperature range
- Material categorization:
For definitions of compliance please see www.vishay.com/doc?99912



APPLICATIONS

- Programmable logic
- Modems
- Answering machines
- General applications

AGENCY APPROVALS

- UL1577, file no. E76222 system code M, double protection
- CSA 22.2 bulletin 5A, double protection
- DIN EN 60747-5-5 (VDE 0884-5)
- FIMKO
- BSI

DESCRIPTION

The TCMD1000, TCMD4000 consist of a photodarlington optically coupled to a gallium arsenide infrared-emitting diodes in either a 4 pin or 16 pin miniflat package.

The elements provide a fixed distance between input and output for highest safety requirements.

ORDERING INFORMATION

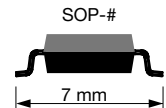
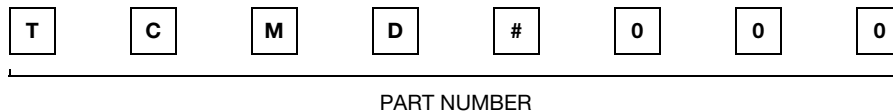

| AGENCY CERTIFIED/PACKAGE | CTR (%) |
|--------------------------|----------|
| UL, cUL, FIMKO, BSI, VDE | > 600 |
| SOP-4 | TCMD1000 |
| SOP-16, quad channel | TCMD4000 |

ABSOLUTE MAXIMUM RATINGS ($T_{amb} = 25\text{ }^{\circ}\text{C}$, unless otherwise specified)

| PARAMETER | TEST CONDITION | SYMBOL | VALUE | UNIT |
|-----------------------|----------------------------|------------|-------|--------------------|
| INPUT | | | | |
| Reverse voltage | | V_R | 6 | V |
| Forward current | | I_F | 60 | mA |
| Forward surge current | $t_p \leq 10\ \mu\text{s}$ | I_{FSM} | 1.5 | A |
| Power dissipation | | P_{diss} | 100 | mW |
| Junction temperature | | T_j | 125 | $^{\circ}\text{C}$ |

**ABSOLUTE MAXIMUM RATINGS** ($T_{amb} = 25\text{ }^{\circ}\text{C}$, unless otherwise specified)

| PARAMETER | TEST CONDITION | SYMBOL | VALUE | UNIT |
|--------------------------------------|--------------------------------------|-----------------|---------------|--------------------|
| OUTPUT | | | | |
| Collector emitter voltage | | V_{CEO} | 35 | V |
| Emitter collector voltage | | V_{ECO} | 7 | V |
| Collector current | | I_C | 80 | mA |
| Collector peak current | $t_p/T = 0.5, t_p \leq 10\text{ ms}$ | I_{CM} | 100 | mA |
| Power dissipation | | P_{diss} | 150 | mW |
| Junction temperature | | T_j | 125 | $^{\circ}\text{C}$ |
| COUPLER | | | | |
| AC isolation test voltage (RMS) | | $V_{ISO}^{(1)}$ | 3750 | V_{RMS} |
| Total power dissipation | | P_{tot} | 250 | mW |
| Operating ambient temperature range | | T_{amb} | - 40 to + 100 | $^{\circ}\text{C}$ |
| Storage temperature range | | T_{stg} | - 40 to + 125 | $^{\circ}\text{C}$ |
| Soldering temperature ⁽²⁾ | | T_{sld} | 260 | $^{\circ}\text{C}$ |

Notes

- Stresses in excess of the absolute maximum ratings can cause permanent damage to the device. Functional operation of the device is not implied at these or any other conditions in excess of those given in the operational sections of this document. Exposure to absolute maximum ratings for extended periods of the time can adversely affect reliability.

⁽¹⁾ Related to standard climate 23/50 DIN 50014.

⁽²⁾ Wave soldering three cycles are allowed. Also refer to "Assembly Instruction" (www.vishay.com/doc?80054).

ELECTRICAL CHARACTERISTICS ($T_{amb} = 25\text{ }^{\circ}\text{C}$, unless otherwise specified)

| PARAMETER | TEST CONDITION | SYMBOL | MIN. | TYP. | MAX. | UNIT |
|--------------------------------------|--|-------------|------|------|------|------|
| input | | | | | | |
| Forward voltage | $I_F = 50\text{ mA}$ | V_F | | 1.25 | 1.6 | V |
| Junction capacitance | $V_R = 0\text{ V}, f = 1\text{ MHz}$ | C_j | | 50 | | pF |
| output | | | | | | |
| Collector emitter voltage | $I_C = 100\text{ }\mu\text{A}$ | V_{CEO} | 35 | | | V |
| Emitter collector voltage | $I_E = 100\text{ }\mu\text{A}$ | V_{ECO} | 7 | | | V |
| Collector dark current | $V_{CE} = 10\text{ V}, I_F = 0, E = 0$ | I_{CEO} | | | 100 | nA |
| coupler | | | | | | |
| Collector emitter saturation voltage | $I_F = 20\text{ mA}, I_C = 5\text{ mA}$ | V_{CEsat} | | | 1 | V |
| Cut-off frequency | $I_F = 10\text{ mA}, V_{CE} = 5\text{ V}, R_L = 100\text{ }\Omega$ | f_c | | 10 | | kHz |
| Coupling capacitance | $f = 1\text{ MHz}$ | C_k | | 0.3 | | pF |

Note

- Minimum and maximum values are testing requirements. Typical values are characteristics of the device and are the result of engineering evaluation. Typical values are for information only and are not part of the testing requirements.

CURRENT TRANSFER RATIO ($T_{amb} = 25\text{ }^{\circ}\text{C}$, unless otherwise specified)

| PARAMETER | TEST CONDITION | PART | SYMBOL | MIN. | TYP. | MAX. | UNIT |
|-----------|--|----------|--------|------|------|------|------|
| I_C/I_F | $V_{CE} = 2\text{ V}, I_F = 1\text{ mA}$ | TCMD1000 | CTR | 600 | 800 | | % |
| | | TCMD4000 | CTR | 600 | 800 | | % |

SWITCHING CHARACTERISTICS ($T_{amb} = 25\text{ }^{\circ}\text{C}$, unless otherwise specified)

| PARAMETER | TEST CONDITION | SYMBOL | MIN. | TYP. | MAX. | UNIT |
|---------------|--|-----------|------|------|------|---------------|
| Rise time | $V_{CE} = 2\text{ V}, I_C = 10\text{ mA}, R_L = 100\text{ }\Omega$ (see figure 1) | t_r | | 300 | | μs |
| Turn-off time | $V_{CE} = 2\text{ V}, I_C = 10\text{ mA}, R_L = 100\text{ }\Omega$ (see figure 1) | t_{off} | | 250 | | μs |

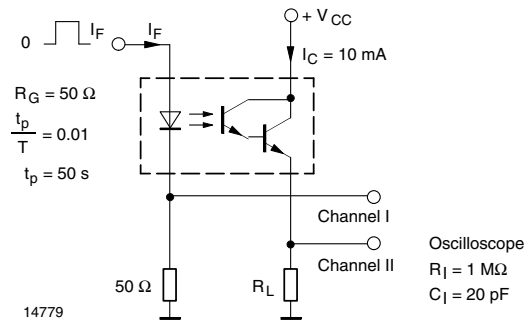

Fig. 1 - Test Circuit, Non-Saturated Operation

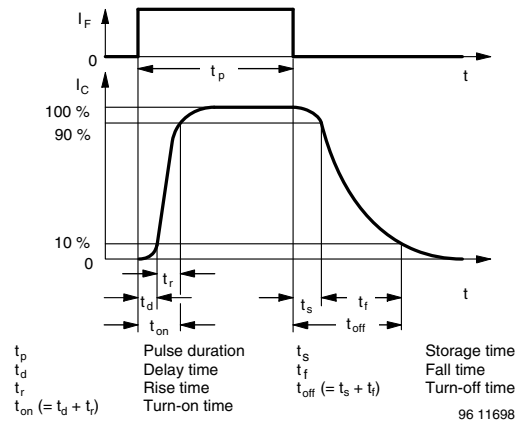

Fig. 2 - Switching Times

| SAFETY AND INSULATION RATINGS | | | | | | |
|---------------------------------------|------------------------|--------|------|-----------|------|------|
| PARAMETER | TEST CONDITION | SYMBOL | MIN. | TYP. | MAX. | UNIT |
| Climatic classification | IEC 68 part 1 | | | 40/110/21 | | |
| Comparative tracking index | | CTI | 175 | | 399 | |
| V _{IOTM} | | | 6000 | | | V |
| V _{IORM} | | | 707 | | | V |
| P _{SO} | | | | | 265 | mW |
| I _{SI} | | | | | 130 | mA |
| T _{SI} | | | | | 150 | °C |
| Creepage distance | | | 5 | | | mm |
| Clearance distance | | | 5 | | | mm |
| Insulation thickness, reinforce rated | per IEC 60950 2.10.5.1 | | 0.4 | | | mm |

Note

- As per IEC 60747-5-2, § 7.4.3.8.1, this optocoupler is suitable for “safe electrical insulation” only within the safety ratings. Compliance with the safety ratings shall be ensured by means of protective circuits.

TYPICAL CHARACTERISTICS (T_{amb} = 25 °C, unless otherwise specified)

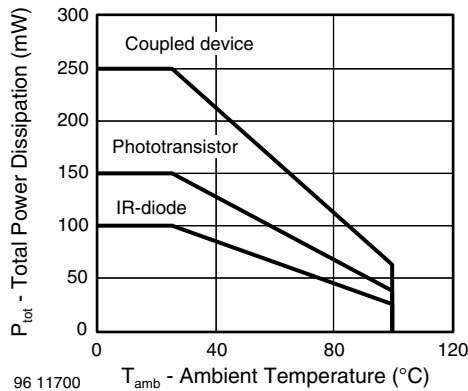

Fig. 3 - Forward Voltage vs. Ambient Temperature

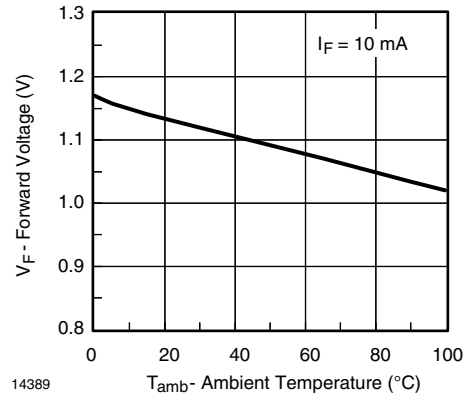

Fig. 4 - Forward Voltage vs. Ambient Temperature



Fig. 5 - Forward Current vs. Forward Voltage

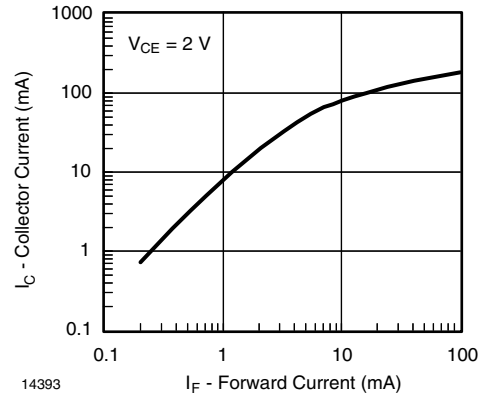

Fig. 8 - Collector Current vs. Forward Current



Fig. 6 - Relative Current Transfer Ratio vs. Ambient Temperature



Fig. 9 - Collector Current vs. Collector Emitter Voltage

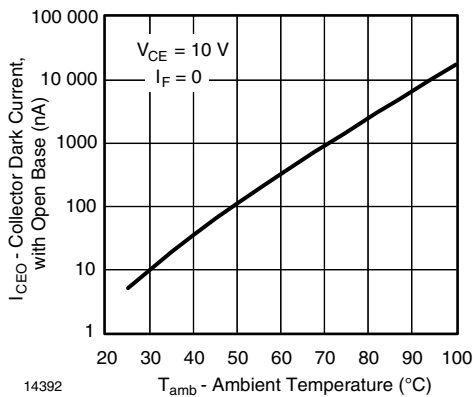

Fig. 7 - Collector Dark Current vs. Ambient Temperature



Fig. 10 - Collector Emitter Saturation Voltage vs. Collector Current

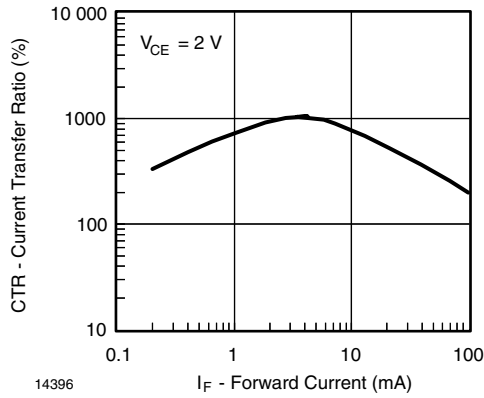
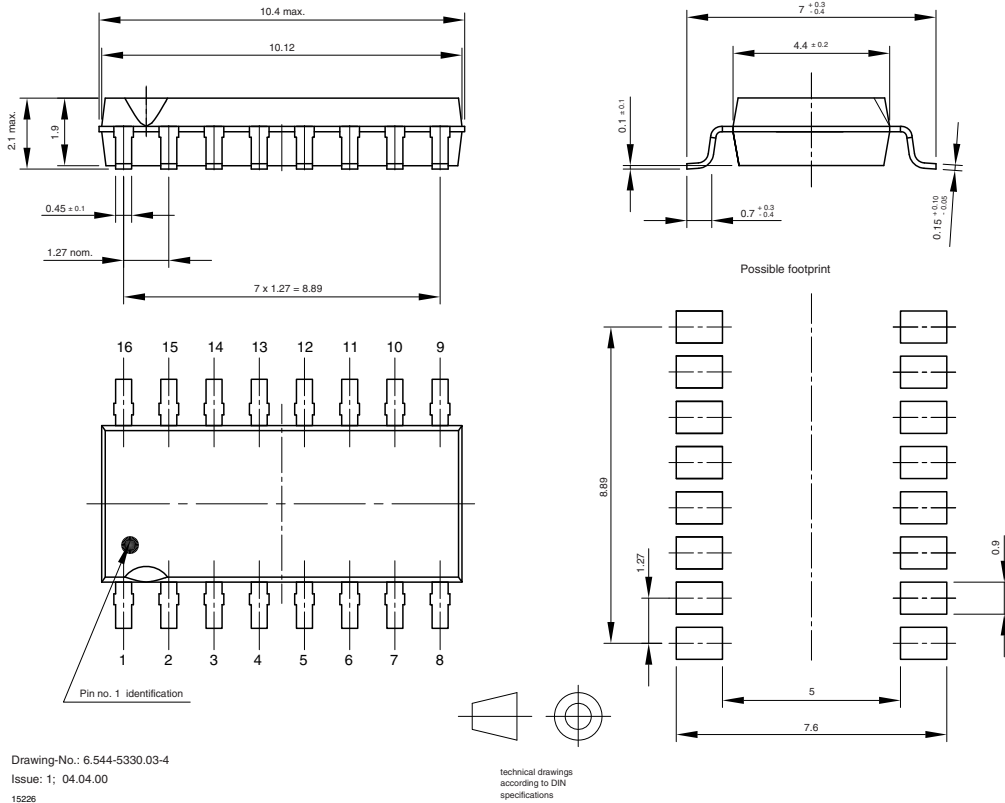

Fig. 11 - Current Transfer Ratio vs. Forward Current

PACKAGE DIMENSIONS in millimeters



16283



Drawing-No.: 6.544-5330.03-4
Issue: 1; 04.04.00
15226

technical drawings
according to DIN
specifications

PACKAGE MARKING

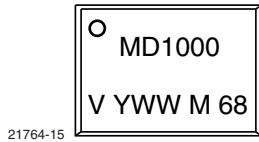

21764-15

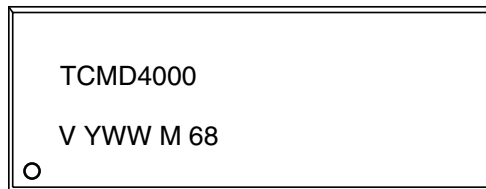

21764-16



Disclaimer

ALL PRODUCT, PRODUCT SPECIFICATIONS AND DATA ARE SUBJECT TO CHANGE WITHOUT NOTICE TO IMPROVE RELIABILITY, FUNCTION OR DESIGN OR OTHERWISE.

Vishay Intertechnology, Inc., its affiliates, agents, and employees, and all persons acting on its or their behalf (collectively, "Vishay"), disclaim any and all liability for any errors, inaccuracies or incompleteness contained in any datasheet or in any other disclosure relating to any product.

Vishay makes no warranty, representation or guarantee regarding the suitability of the products for any particular purpose or the continuing production of any product. To the maximum extent permitted by applicable law, Vishay disclaims (i) any and all liability arising out of the application or use of any product, (ii) any and all liability, including without limitation special, consequential or incidental damages, and (iii) any and all implied warranties, including warranties of fitness for particular purpose, non-infringement and merchantability.

Statements regarding the suitability of products for certain types of applications are based on Vishay's knowledge of typical requirements that are often placed on Vishay products in generic applications. Such statements are not binding statements about the suitability of products for a particular application. It is the customer's responsibility to validate that a particular product with the properties described in the product specification is suitable for use in a particular application. Parameters provided in datasheets and / or specifications may vary in different applications and performance may vary over time. All operating parameters, including typical parameters, must be validated for each customer application by the customer's technical experts. Product specifications do not expand or otherwise modify Vishay's terms and conditions of purchase, including but not limited to the warranty expressed therein.

Except as expressly indicated in writing, Vishay products are not designed for use in medical, life-saving, or life-sustaining applications or for any other application in which the failure of the Vishay product could result in personal injury or death. Customers using or selling Vishay products not expressly indicated for use in such applications do so at their own risk. Please contact authorized Vishay personnel to obtain written terms and conditions regarding products designed for such applications.

No license, express or implied, by estoppel or otherwise, to any intellectual property rights is granted by this document or by any conduct of Vishay. Product names and markings noted herein may be trademarks of their respective owners.