

Trench Schottky Rectifier

FEATURES

- Patented Trench Schottky technology
- Excellent high temperature stability
- Low forward voltage
- Low power loss/ high efficiency
- High forward surge capability
- Compliant to RoHS directive 2011/65/EU and in accordance to WEEE 2002/96/EC
- Halogen-free according to IEC 61249-2-21 definition

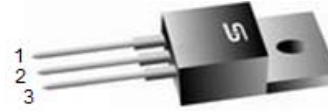

TO-220AB

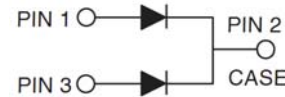

TYPICAL APPLICATIONS

Trench Schottky barrier rectifier are designed for high frequency miniature switched mode power supplies such as adapters, lighting and on-board DC/DC converters.

MECHANICAL DATA

Case: TO-220AB

Molding compound meets UL 94 V-0 flammability rating

Packing code with suffix "G" means green compound (halogen-free)

Terminal: Matte tin plated leads, solderable per JESD22-B102

Meet JESD 201 class 2 whisker test

Polarity: As marked

Mounting torque: 0.56 Nm max.

Weight: 1.88 g (approximately)

MAXIMUM RATINGS AND ELECTRICAL CHARACTERISTICS (T _A = 25°C unless otherwise noted)											
PARAMETER		SYMBOL	TST10H 100CW	TST10H 120CW	TST10H 150CW	TST10H 200CW					UNIT
Maximum repetitive peak reverse voltage		V _{RRM}	100	120	150	200					V
Maximum average forward rectified current	per device	I _{F(AV)}	10								A
	per diode		5								
Peak forward surge current, 8.3ms single half sine-wave superimposed on rated load per diode		I _{FSM}	100								A
Voltage rate of change (Rated V _R)		dV/dt	10000								V/μs
			TYP	MAX	TYP	MAX	TYP	MAX	TYP	MAX	
Instantaneous forward voltage per diode (Note1)	I _F = 5A	T _J = 25°C	0.62	0.70	0.69	0.79	0.78	0.88	0.81	0.91	V
	I _F = 5A	T _J = 125°C	0.55	0.63	0.58	0.66	0.64	0.72	0.67	0.75	
Instantaneous reverse current per diode at rated reverse voltage	T _J = 25°C		-	100	-	100	-	100	-	100	μA
	T _J = 125°C		-	15	-	15	1.5	10	1.5	10	mA
Typical thermal resistance per diode		R _{θJC}	3.2								°C/W
Operating junction temperature range		T _J	- 55 to +150								°C
Storage temperature range		T _{STG}	- 55 to +150								°C

Note 1: Pulse test with pulse width=300μs, 1% duty cycle

ORDERING INFORMATION

PART NO.	PACKING CODE	PACKING CODE SUFFIX	PACKAGE	PACKING
TST10HXXCW (Note 1)	C0	G	TO-220AB	50 / Tube

Note 1: "XXX" defines voltage from 100V (TST10H100CW) to 200V (TST10H200CW)

EXAMPLE

PREFERRED PART NO.	PART NO.	PACKING CODE	PACKING CODE SUFFIX	DESCRIPTION
TST10H150CW C0G	TST10H150CW	C0	G	Green compound

RATINGS AND CHARACTERISTICS CURVES

($T_A = 25^\circ\text{C}$ unless otherwise noted)

FIG. 1 FORWARD CURRENT DERATING CURVE

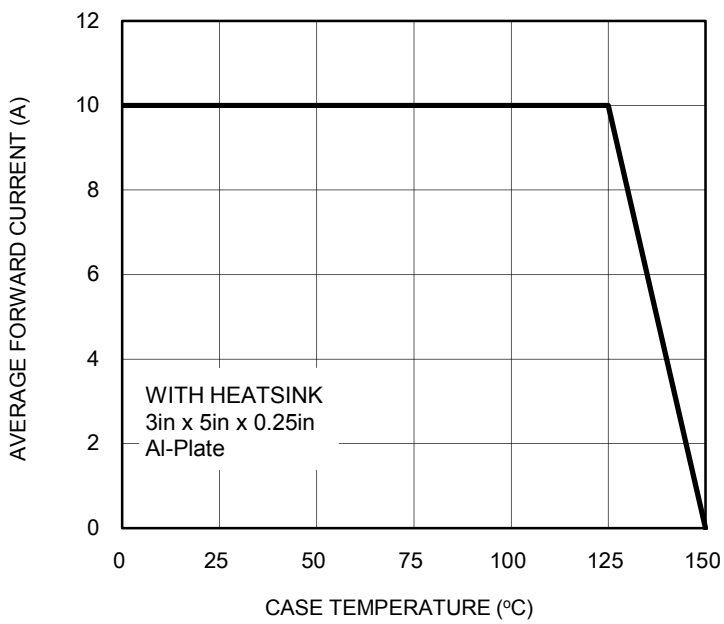

FIG. 2 TYPICAL FORWARD CHARACTERISTICS

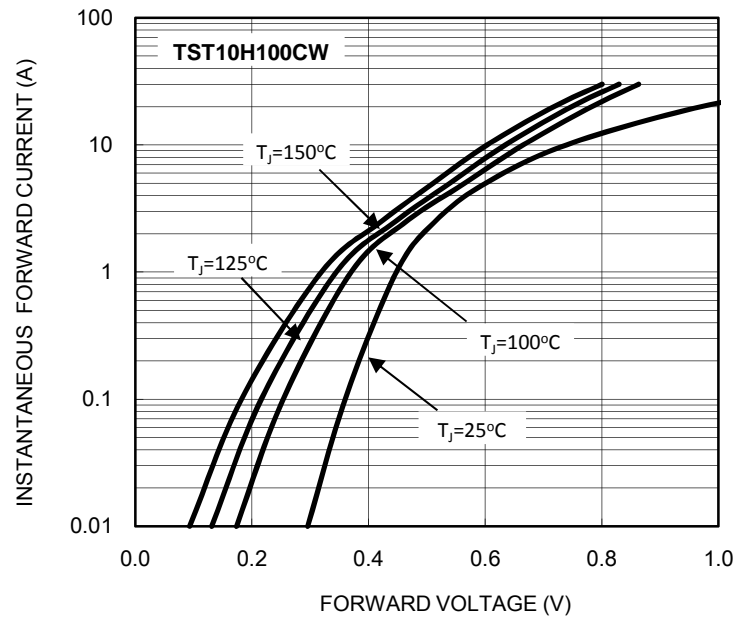

FIG. 3 TYPICAL FORWARD CHARACTERISTICS

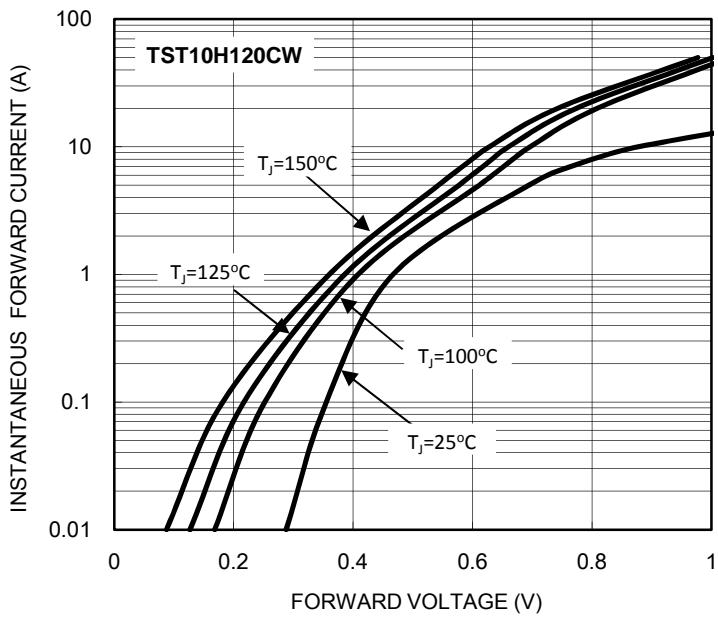

FIG. 4 TYPICAL FORWARD CHARACTERISTICS

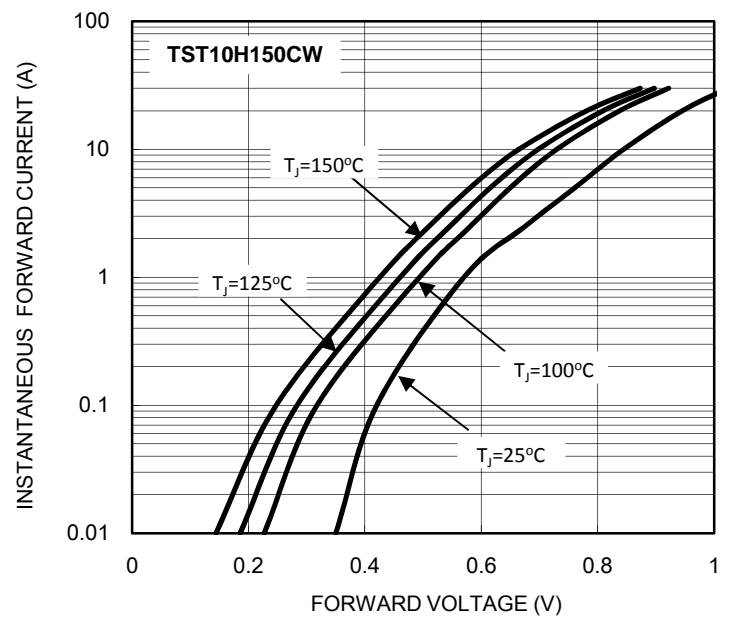

FIG. 5 TYPICAL FORWARD CHARACTERISTICS

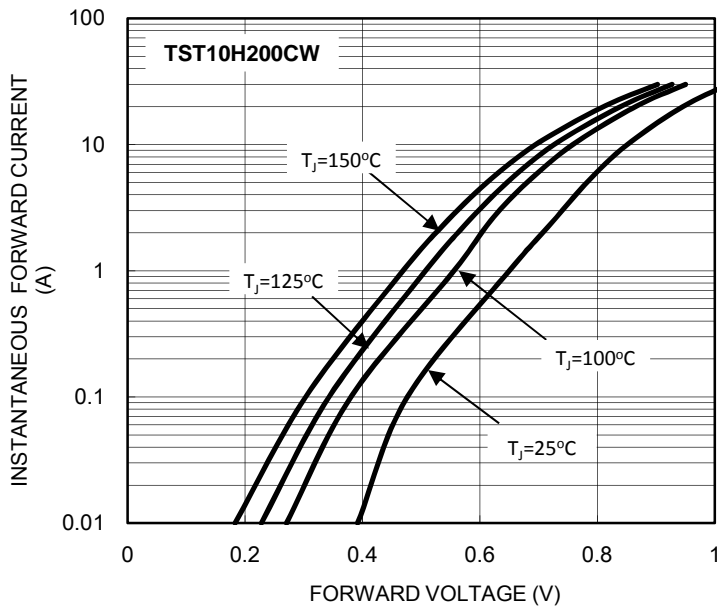

FIG. 6 TYPICAL REVERSE CHARACTERISTICS

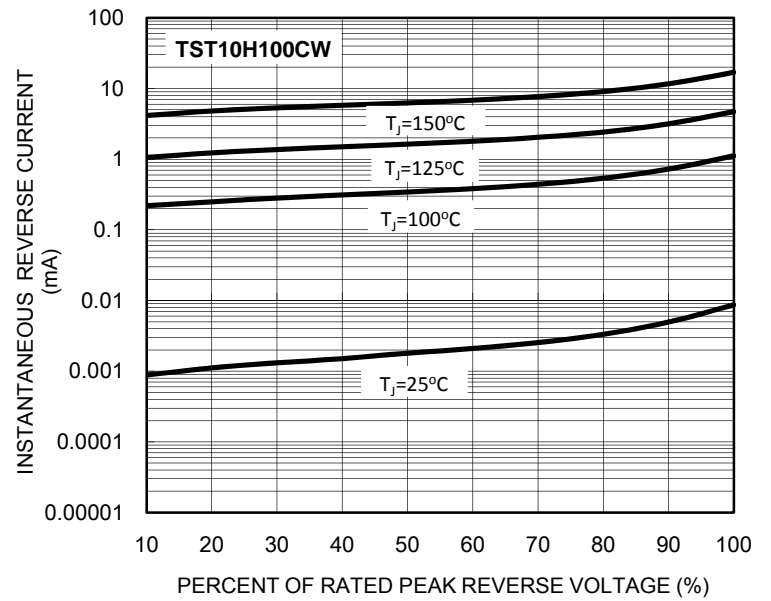

FIG. 7 TYPICAL REVERSE CHARACTERISTICS

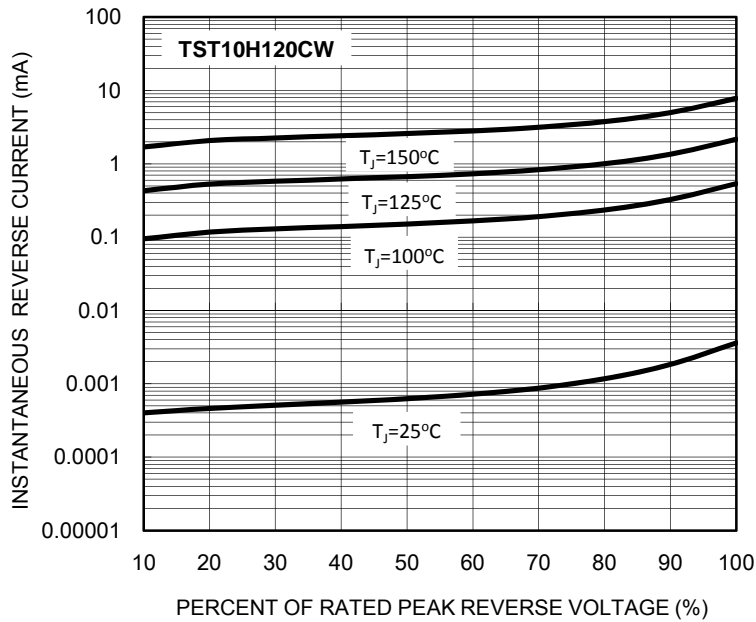

FIG. 8 TYPICAL REVERSE CHARACTERISTICS

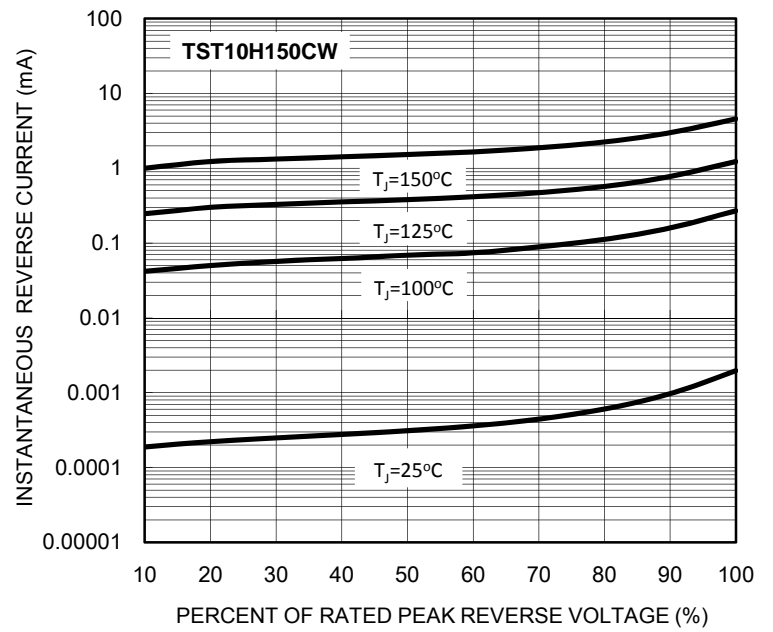

FIG. 9 TYPICAL REVERSE CHARACTERISTICS

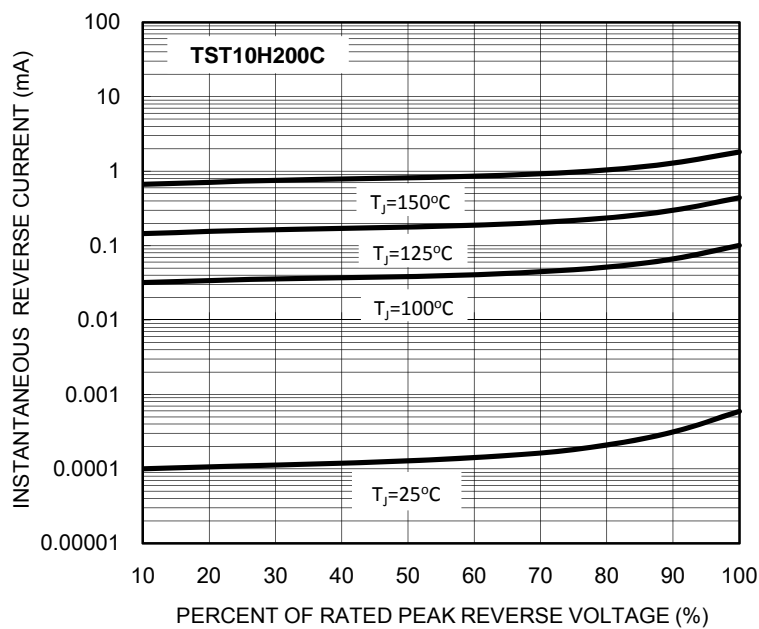
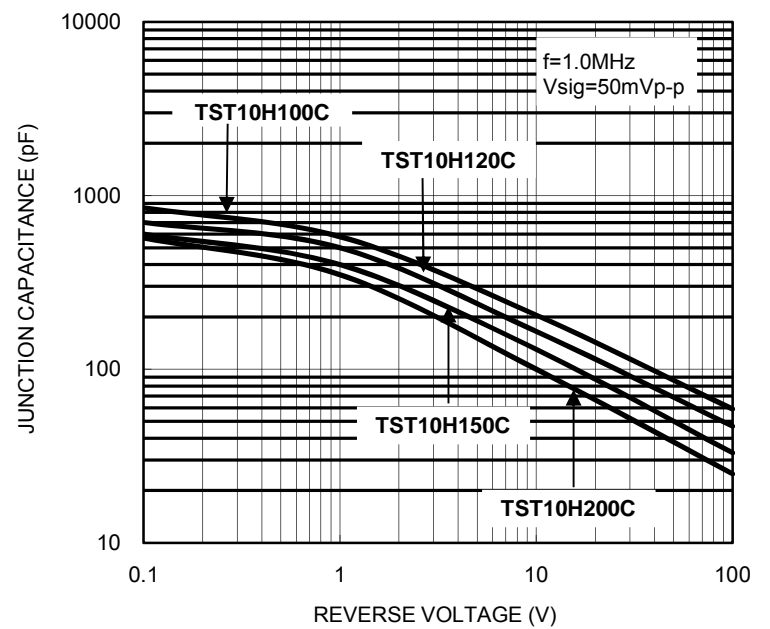
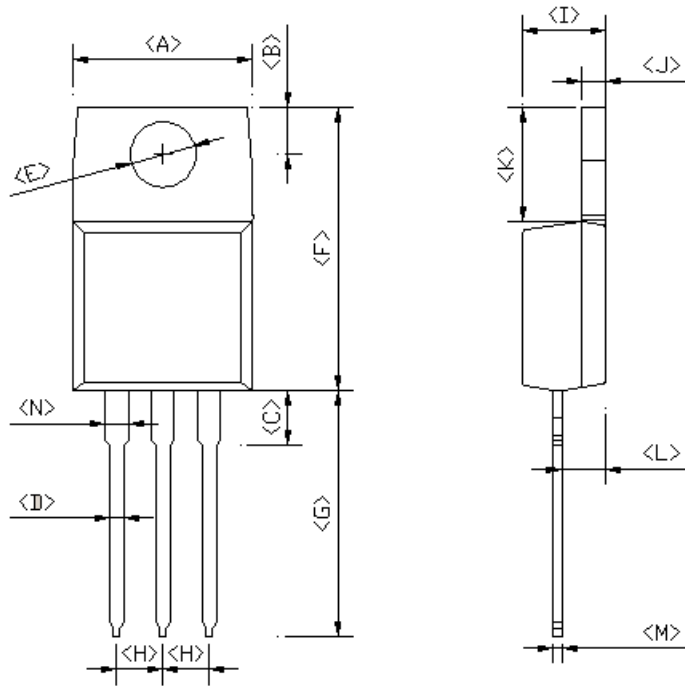

FIG. 10 TYPICAL JUNCTION CAPACITANCE



PACKAGE OUTLINE DIMENSIONS
TO-220AB



DIM.	Unit (mm)		Unit (inch)	
	Min	Max	Min	Max
A	-	10.50	-	0.413
B	2.54	3.44	0.100	0.135
C	2.80	4.20	0.110	0.165
D	0.68	0.94	0.027	0.037
E	3.54	4.00	0.139	0.157
F	14.60	16.00	0.575	0.630
G	13.19	14.79	0.519	0.582
H	2.41	2.67	0.095	0.105
I	4.42	4.76	0.174	0.187
J	1.14	1.40	0.045	0.055
K	5.84	6.86	0.230	0.270
L	2.20	2.80	0.087	0.110
M	0.35	0.64	0.014	0.025
N	0.95	1.45	0.037	0.057

MARKING DIAGRAM



- P/N = Specific Device Code
- G = Green Compound
- YWW = Date Code
- F = Factory Code

Notice

Specifications of the products displayed herein are subject to change without notice. TSC or anyone on its behalf, assumes no responsibility or liability for any errors or inaccuracies.

Information contained herein is intended to provide a product description only. No license, express or implied, to any intellectual property rights is granted by this document. Except as provided in TSC's terms and conditions of sale for such products, TSC assumes no liability whatsoever, and disclaims any express or implied warranty, relating to sale and/or use of TSC products including liability or warranties relating to fitness for a particular purpose, merchantability, or infringement of any patent, copyright, or other intellectual property right.

The products shown herein are not designed for use in medical, life-saving, or life-sustaining applications. Customers using or selling these products for use in such applications do so at their own risk and agree to fully indemnify TSC for any damages resulting from such improper use or sale.