



# Product Change Notification



Product Group: OPT/Thu Apr 22, 2021/PCN-OPT-1179-2021-REV-0

## Redesign of IL300 Linear optocoupler product series

**DESCRIPTION OF CHANGE:** Vishay introduces a new design for the IL300 series. This design will use a new type of construction and new dies. As a result there is a slight difference in the dimensions of the package. The new package will be white in color and still conforms to the industry standards. There is no change in the manufacturing location. There are some electrical specification changes as well. The major ones are as follows:

K1, K2 gain min and max  
IP1, IP2 typ. values  
VF typ. value  
Reduced K3 bin categories  
Rise and Fall time typ. values

For a detailed comparison of the new and current design, please refer to document "Details of changes \_ PCN OMV-1179-2021.pdf"

**REASON FOR CHANGE:** To transfer to a new production line according to state of the art technology with increased production capacity and to change to a more robust new construction.

**EXPECTED INFLUENCE ON QUALITY/RELIABILITY/PERFORMANCE:** These products have undergone a comprehensive qualification and characterization program. There is no adverse effects on the quality and performance of the product.

**PART NUMBERS/SERIES/FAMILIES AFFECTED:** Please see materials list on the succeeding page.

**VISHAY BRAND(s):** Vishay Semiconductors

**TIME SCHEDULE:**

Start Shipment Date: Mon Jul 5, 2021

**SAMPLE AVAILABILITY:** April 19, 2021

**PRODUCT IDENTIFICATION:** This change can be tracked by package colour

**QUALIFICATION DATA:** This change has been rigorously qualified by company and industry standard qualifications. The qualification data is available upon request

**This PCN is considered approved, without further notification, unless we receive specific customer concerns before Wed Jun 30, 2021 or as specified by contract.**

**ISSUED BY:** Nadidedeniz Goerk, Nadidedeniz.Goerk@vishay.com

**For further information, please contact your regional Vishay office.**

**CONTACT INFORMATION:**

Vishay Intertechnology, Inc.

Corporate Headquarters 63 Lincoln Highway, Malvern, PA 19355-2143 U.S.A. Phone (610) 644-1300 Fax (610) 296-0657 [www.vishay.com](http://www.vishay.com)

ONE OF THE WORLD'S LARGEST MANUFACTURERS OF DISCRETE SEMICONDUCTORS AND PASSIVE COMPONENT



# Product Change Notification



Product Group: OPT/Thu Apr 22, 2021/PCN-OPT-1179-2021-REV-0

## Americas

VISHAY Intertechnologies, Inc., Business  
Marketing The Americas - Opto  
2585 Junction Avenue  
San Jose, California United States 95134-  
1923  
Phone: +1-408-567-8358  
Fax: +1 408-240-5687

## Europe

VISHAY Semiconductor GmbH, Business  
Marketing Europe Opto  
Theresienstr. 2  
Heilbronn Germany 74025  
Phone: +49-7131-67-2113  
Fax: +49-7131-67-3144

## Asia

VISHAY Intertechnology Asia Pte. Ltd.,  
Business Marketing Asia/Japan  
25 Tampines Street 92  
Keppel Building # 02-00  
Singapore Singapore 528877  
Phone: +65 6780 7879  
Fax: +65 6780 7897

Vishay Intertechnology, Inc.

Corporate Headquarters 63 Lincoln Highway, Malvern, PA 19355-2143 U.S.A. Phone (610) 644-1300 Fax (610) 296-0657 [www.vishay.com](http://www.vishay.com)

ONE OF THE WORLD'S LARGEST MANUFACTURERS OF DISCRETE SEMICONDUCTORS AND PASSIVE COMPONENT



# Product Change Notification



Product Group: OPT/Thu Apr 22, 2021/PCN-OPT-1179-2021-REV-0

IL300	IL300-3124	IL300-DEFG	IL300-DEFG-X001	IL300-DEFG-X006
IL300-DEFG-X007	IL300-DEFG-X007T	IL300-DEFG-X009T	IL300-DEFG-X016	IL300-DEFG-X017
IL300-DEFG-X017T	IL300-DEF-X009T	IL300-E	IL300-EF	IL300-EF-X007
IL300-EF-X007T	IL300-EF-X009T	IL300-EF-X016	IL300-EF-X017	IL300-EF-X017T
IL300-E-X006	IL300-E-X007T	IL300-E-X009T	IL300-F	IL300-F-X001
IL300-F-X007	IL300-F-X007T	IL300-F-X009	IL300-F-X009T	IL300-F-X016
IL300-F-X017T	IL300-X007	IL300-X007T	IL300-X009T	IL300-X016
IL300-X017				

Vishay Intertechnology, Inc.

Corporate Headquarters 63 Lincoln Highway, Malvern, PA 19355-2143 U.S.A. Phone (610) 644-1300 Fax (610) 296-0657 [www.vishay.com](http://www.vishay.com)

ONE OF THE WORLD'S LARGEST MANUFACTURERS OF DISCRETE SEMICONDUCTORS AND PASSIVE COMPONENT

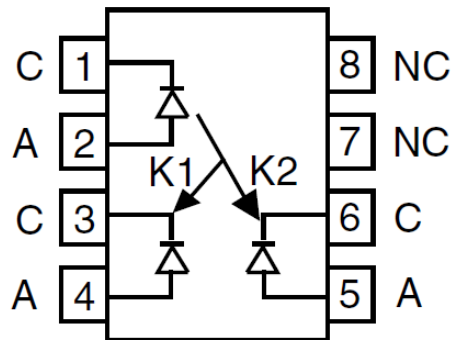

## Details of Changes to IL300 Series Addressed in PCN OMV-1179-2021

# 1 1. Contents

## PCN OMV-1179-2021

Section	Page
<b>1 1. CONTENTS</b> .....	<b>2</b>
<b>2 INTRODUCTION</b> .....	<b>3</b>
2.1 GENERAL PCN INFORMATION .....	3
<b>3 CHANGES ASSOCIATED WITH THIS PCN.</b> .....	<b>2</b>
3.1 EMITTER CHIP CHANGE .....	2
3.2 DETECTOR CHIP CHANGE .....	2
3.3 PACKAGE.....	2
3.4 MARKING .....	4
3.5 PRODUCTION LINE.....	4
3.6 MISCELLANEOUS .....	4
3.7 SPECIFICATION CHANGES .....	4
3.7.1 <i>Changes to Data Sheet limits.</i> .....	4
3.7.2 <i>Corrections to the current datasheet</i> .....	5
3.8 CHARACTERISTICS.....	5

## 2 Introduction

This document presents additional information with respect to the changes addressed in PCN OMV-1179-2021 concerning the IL300, linear optocoupler, series products.

### 2.1 General PCN information

The PCN presents changes to the IL300 series (see detailed list below). This product uses Vishay's new more robust Double Mold Planar Process (DMP). The linear coupler consists of 3 dies, one IrLED and two PIN diodes. The AlGaAs IrLED is optically coupled to both the feedback PIN diode and the output PIN diode in a bifurcated arrangement. These components are encapsulated in a DIP8 plastic package. The final assembly and test occur in Vishay's facility in Krubong, Malaysia.

The changes consist of a redesigning of the product and the transfer of the product to a new production line of cutting edge technology with increased production capacity. The new component also utilizes environmentally friendly material.

The complete list of products impacted by the PCN is listed below:

Material
IL300
IL300-3124
IL300-DEFG
IL300-DEFG-X001
IL300-DEFG-X006
IL300-DEFG-X007
IL300-DEFG-X007T
IL300-DEFG-X009T
IL300-DEFG-X016
IL300-DEFG-X017
IL300-DEFG-X017T
IL300-DEF-X009T

Material
IL300-E
IL300-EF
IL300-EF-X007
IL300-EF-X007T
IL300-EF-X009T
IL300-EF-X016
IL300-EF-X017
IL300-EF-X017T
IL300-E-X006
IL300-E-X007T
IL300-E-X009T
IL300-F

Material
IL300-F-X001
IL300-F-X007
IL300-F-X007T
IL300-F-X009
IL300-F-X009T
IL300-F-X016
IL300-F-X017T
IL300-X007
IL300-X007T
IL300-X009T
IL300-X016
IL300-X017

The new parts were realized by pairing up a new emitter with an improved version of the current detector (PIN diode) to meet the same performance requirements with minimum change to datasheet specifications. The new emitter uses MOVPE manufacturing technology allowing more consistent performance across all products, while the detector is a derivative of the existing product.

Both current and new version of these chips are sourced out of Vishay's fabrication lines in Heilbronn Germany. The DMP construction and process represents a new manufacturing line from our existing factory in Krubong, Malaysia.

## 3 Changes associated with this PCN.

### 3.1 Emitter chip change.



The emitter was revised to the MOVPE multi-quantum well GaAlAs technology to provide a greater light output to achieve product specifications comparable with the current product.

### 3.2 Detector chip change

The detector is a derivative of the current chip (the difference between the two is not detectable by physical appearance)

### 3.3 Package

The package has been redesigned resulting in several changes. The most notable of these changes is the colour of the outer molding compound. Less noticeable is the change in construction and the change in package dimensions.

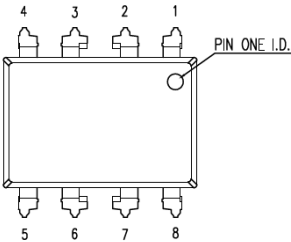
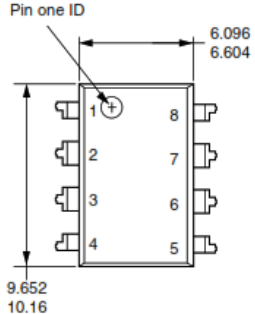
NEW	CURRENT
<b>Color of Package</b>	
	
<b>Package Dimension:</b> The package still conforms to the JEDEC standard, some of the dimensions have slight changes.	
	

CONFIDENTIAL

THIS DOCUMENT IS SUBJECT TO CHANGE WITHOUT NOTICE. THE PRODUCTS DESCRIBED HEREIN AND THIS DOCUMENT ARE SUBJECT TO SPECIFIC DISCLAIMERS, SET FORTH AT [www.vishay.com/doc?91000](http://www.vishay.com/doc?91000)

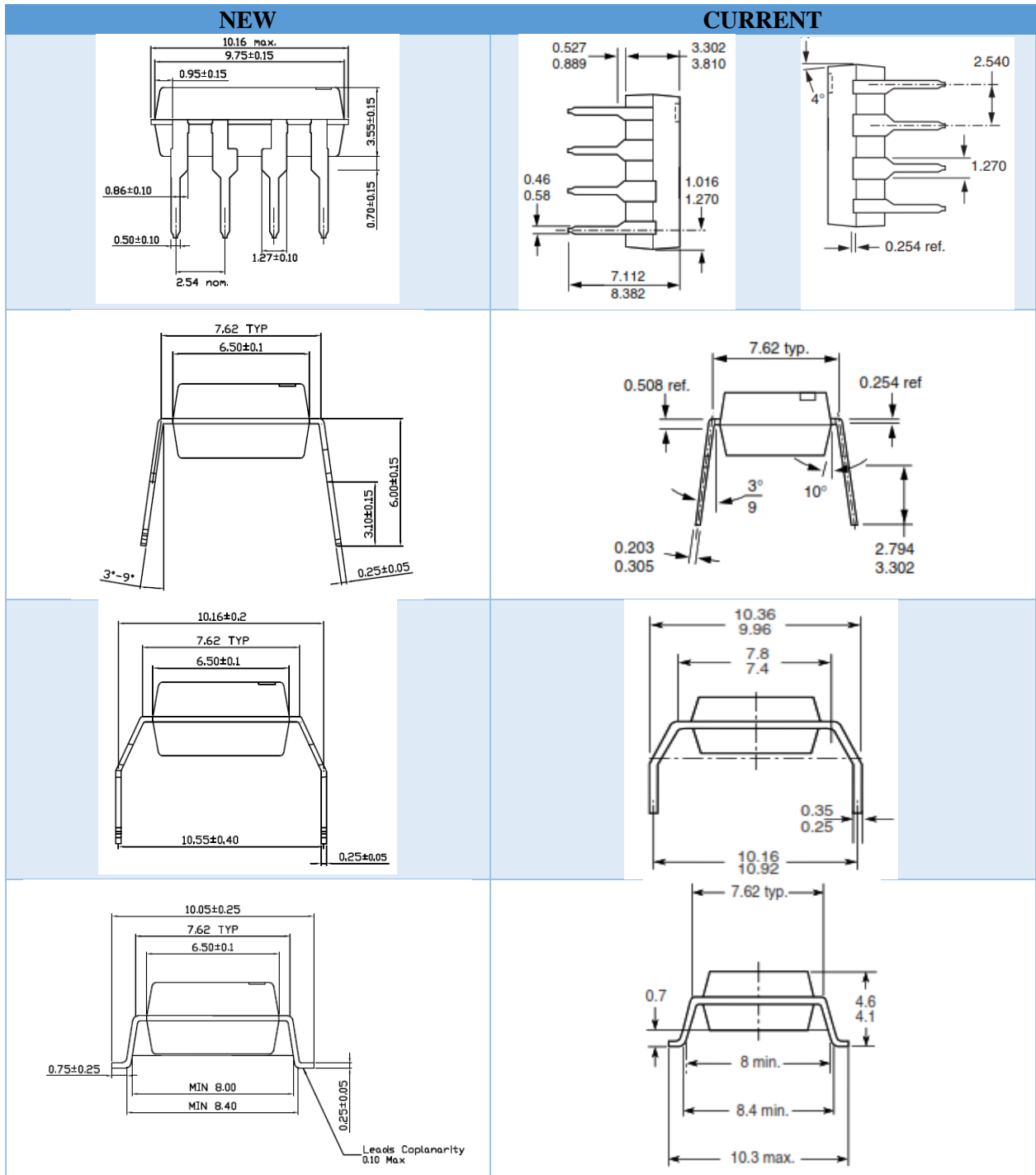

CONFIDENTIAL

THIS DOCUMENT IS SUBJECT TO CHANGE WITHOUT NOTICE. THE PRODUCTS DESCRIBED HEREIN AND THIS DOCUMENT ARE SUBJECT TO SPECIFIC DISCLAIMERS, SET FORTH AT [www.vishay.com/doc?91000](http://www.vishay.com/doc?91000)



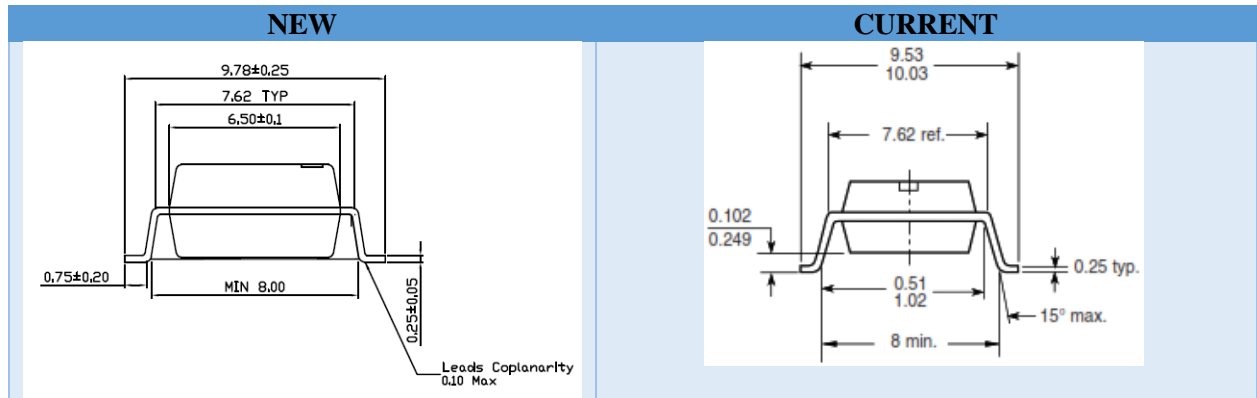

### 3.4 Marking

There is no change in product marking

### 3.5 Production Line

The product has been transferred to a state of the art production line with increased production capacity.

### 3.6 Miscellaneous

1. Existing Product names will not change.
2. The new parts all retain the same safety agency certification as the current version.
3. There are no changes in the production testing of the product.
4. New Links to resources have been added to the data sheet.

### 3.7 Specification Changes

Due to the change of the die some of the characteristics will change. These changes are reflected in the typical values in the data sheet as demonstrated in the table below.

	New	Current	units
<b>Forward Voltage (<math>V_F</math>) @ <math>10mA I_F</math></b>	1.4	1.25	V
<b>Short circuit Current (<math>I_{sc}</math>) @ <math>10mA I_F</math></b>	90	120	$\mu A$
<b>Output Current (<math>I_{p1}, I_{p2}</math>) @ <math>10mA I_F, V_{det} = -15 V</math></b>	90	120	$\mu A$
<b>K1, K2 Output Current Gain @ <math>10mA I_F, V_{det} = -15 V</math></b>	0.009	0.012	
<b>Rise time @ <math>I_F=10mA</math></b>	0.8	1.75	$\mu s$
<b>Fall time @ <math>I_F=10mA</math></b>	0.8	1.75	$\mu s$

The parameter changes are small and fall within the existing data sheet specification.

#### 3.7.1 Changes to Data Sheet limits.

The following shows a comparison of the parametric limits that were changed in the data sheet as a result of this new design.

			New			Current			
<b>ABSOLUTE MAXIMUM RATINGS</b>									
PARAMETER	TEST CONDITION	SYMBOL	VALUE			VALUE			UNIT
Input Power distribution		Pdiss	100			160			mW
Derate linearly from 25 °C			-			2.13			mW/°C
Input Thermal resistance		R <sub>th</sub>	-			470			°K/W
Input Junction temperature		T <sub>j</sub>	125			100			°C
Output Power: Derate linearly from 25 °C			-			0.65			mW/°C
Input Thermal resistance		R <sub>th</sub>	-			1500			°K/W
Input Junction temperature		T <sub>j</sub>	125			100			°C
Total Package Power distribution at 25°C		Pdiss	150			210			mW
Derate linearly from 25 °C			-			2.8			mW/°C
<b>ELECTRICAL CHARACTERISTICS</b>									
PARAMETER	TEST CONDITION	SYMBOL	MIN	TYP.	MAX	MIN	TYP.	MAX	UNIT
Forward Voltage	I <sub>F</sub> = 10 mA	V <sub>F</sub>		1.4			1.25		V
V <sub>F</sub> temperature coefficient		ΔV <sub>F</sub> /Δ°C		-			-2.2		mW/°C
Input Junction capacitance	V <sub>F</sub> = 0 V, f = 1 MHz	C <sub>j</sub>		26			15		pF
Input Dynamic resistance	I <sub>F</sub> = 10 mA	ΔV <sub>F</sub> /ΔI <sub>F</sub>		-			6		Ω
Output short circuit current	I <sub>F</sub> = 10 mA	I <sub>SC</sub>		90			120		μA
Output noise equivalent power	V <sub>det</sub> = 15V	NEP		-			4 x 10 <sup>-14</sup>		Ω/√Hz
K1, servo gain (I <sub>F1</sub> /I <sub>F</sub> )	I <sub>F</sub> = 10 mA, V <sub>det</sub> = -15 V	K1	0.005	0.009	0.015	0.006	0.012	0.017	
Servo photocurrent	I <sub>F</sub> = 10 mA, V <sub>det</sub> = -15 V	I <sub>P1</sub>		90			120		μA
K2, servo gain (I <sub>P2</sub> /I <sub>F</sub> )	I <sub>F</sub> = 10 mA, V <sub>det</sub> = -15 V	K2	0.005	0.009	0.015	0.006	0.012	0.017	
Forward photocurrent	I <sub>F</sub> = 10 mA, V <sub>det</sub> = -15 V	I <sub>P2</sub>		90			120		μA

### 3.7.2 Corrections to the current datasheet

The test condition for Transfer Gain Stability has been corrected with T<sub>amb</sub> = 0 °C to 75 °C.  
The test condition for Transfer Gain Linearity has been corrected with I<sub>F</sub> = 2.0 to 10 mA

## 3.8 Characteristics

Detailed product characterization has been performed on this series of products. Some slight changes in electrical parameters and performance were observed.

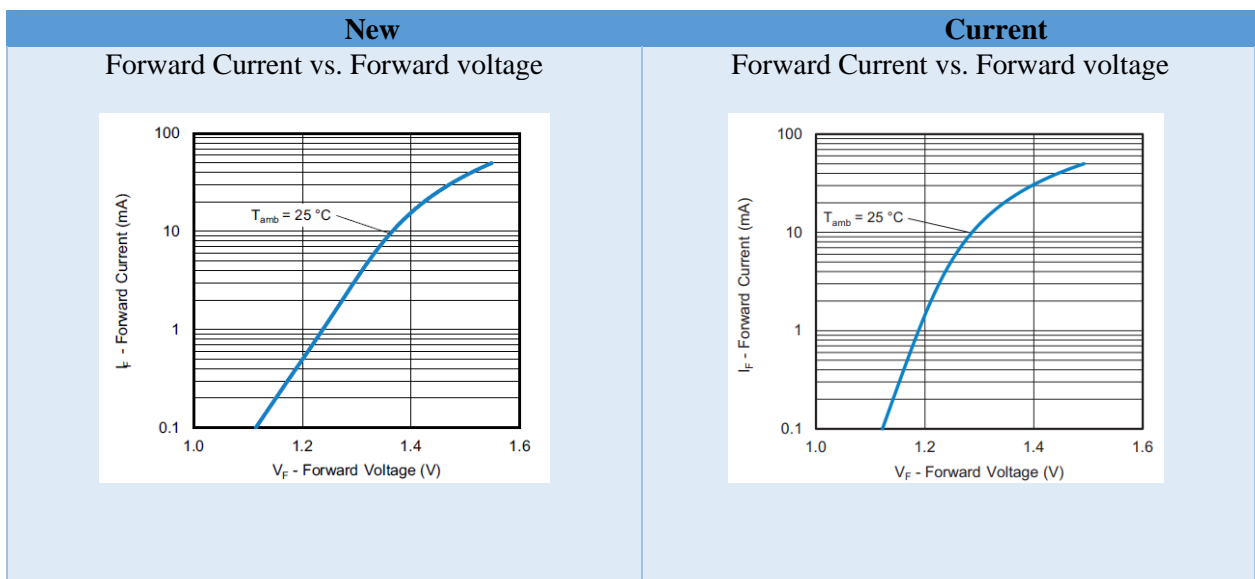

CONFIDENTIAL

THIS DOCUMENT IS SUBJECT TO CHANGE WITHOUT NOTICE. THE PRODUCTS DESCRIBED HEREIN AND THIS DOCUMENT ARE SUBJECT TO SPECIFIC DISCLAIMERS, SET FORTH AT [www.vishay.com/doc?91000](http://www.vishay.com/doc?91000)

Servo Photocurrent vs. Forward Current

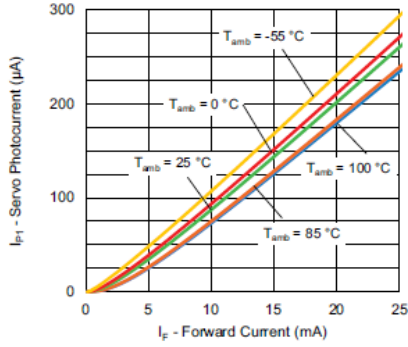

Servo Photocurrent vs. Forward Current

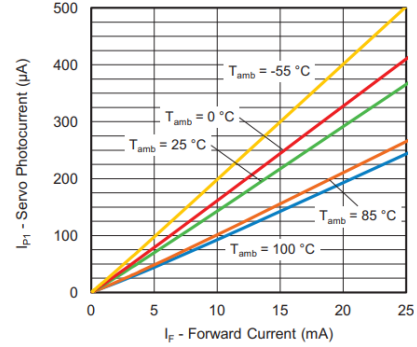

Normalized Photodiode Current vs. Forward Current

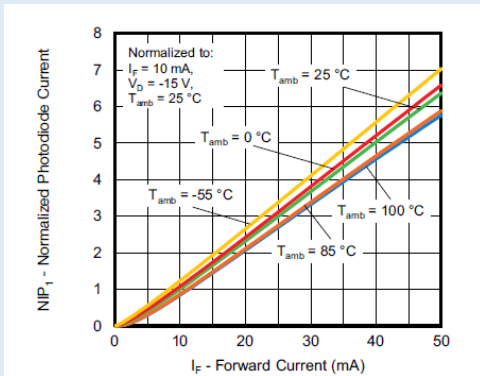

Normalized Photodiode Current vs. Forward Current

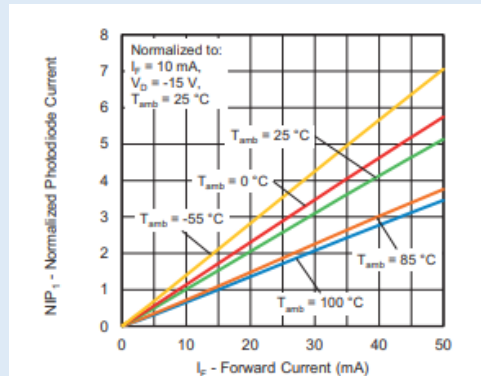

Servo Gain vs. Forward Current

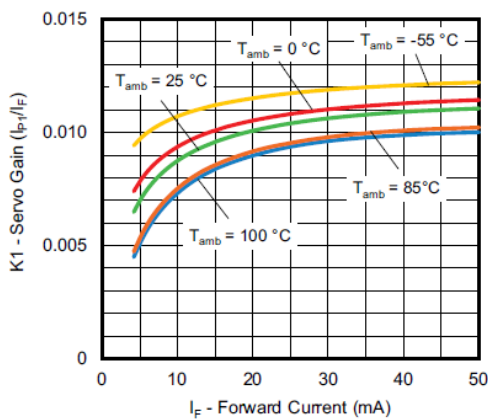

Servo Gain vs. Forward Current

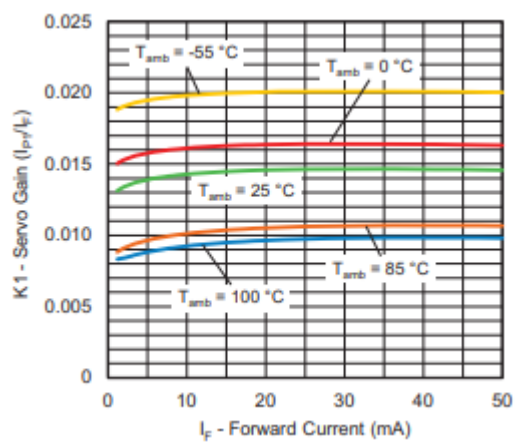

Normalized Transfer Gain vs. Forward Current

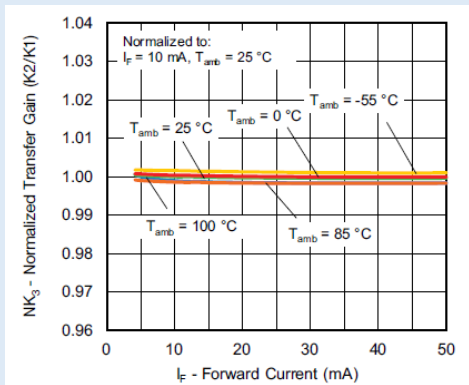

Normalized Transfer Gain vs. Forward Current

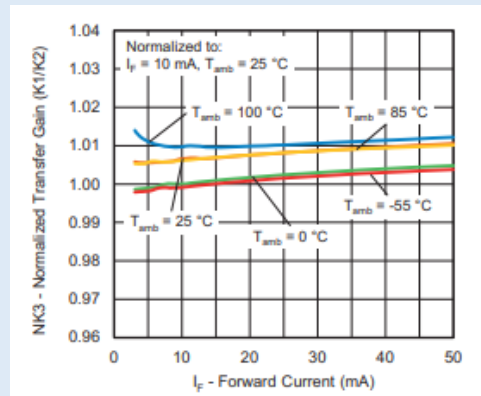

Voltage Gain vs. Frequency (2 mA)

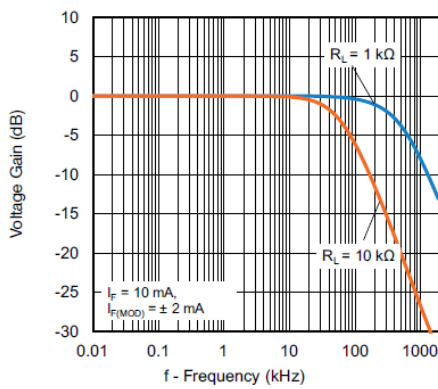

Voltage Gain vs. Frequency (2 mA)

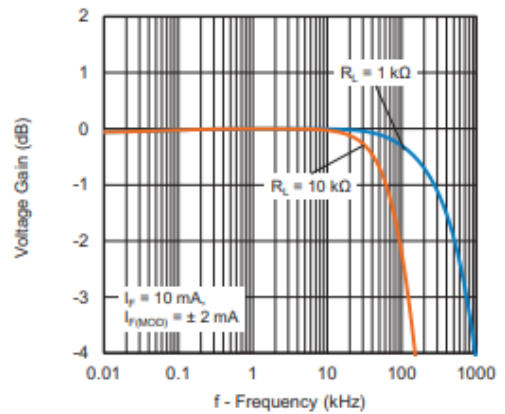

Voltage Gain vs. Frequency

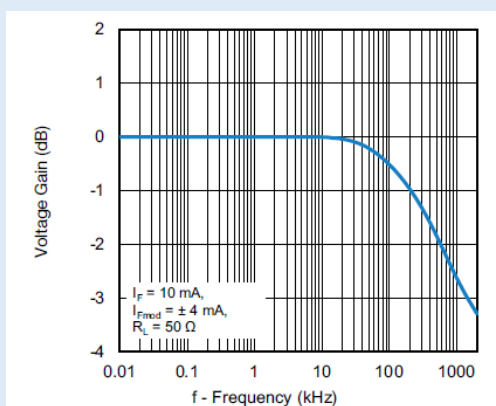

Voltage Gain vs. Frequency

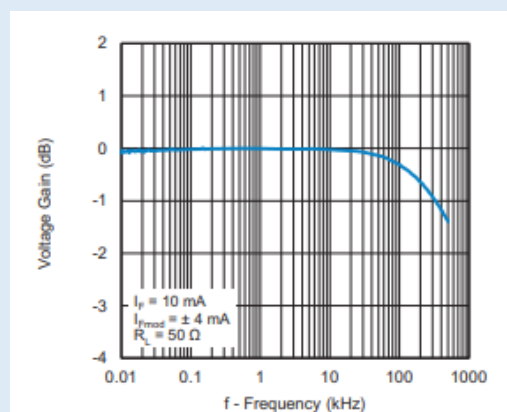

Phase Angle vs. Frequency

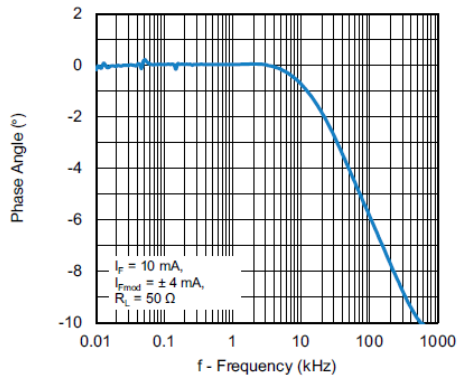

Phase Angle vs. Frequency

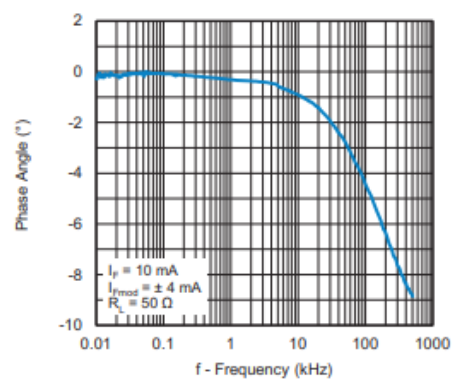

Common-Mode Rejection Ratio vs. Frequency

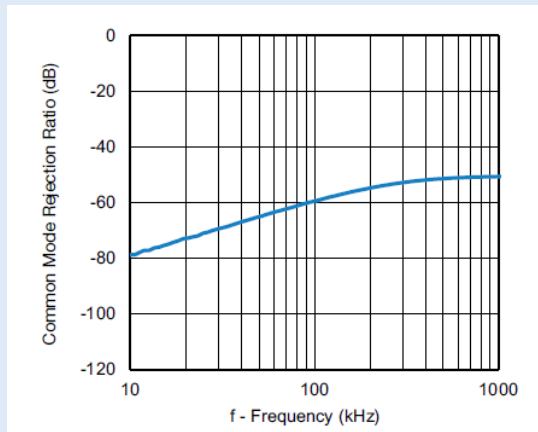

Common-Mode Rejection Ratio vs. Frequency

