

6-line IPAD™, EMI filter including ESD protection

Datasheet - production data

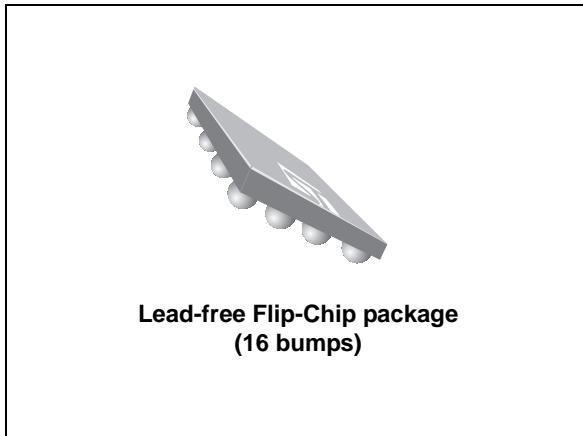

- Very thin package: 0.65 mm
- High efficiency in ESD suppression
- High reliability offered by monolithic integration
- High reducing of parasitic elements through integration and wafer level packaging

Complies with the following standards

- IEC 61000-4-2 level 4 on external pins
 - 15 kV (air discharge)
 - 8 kV (contact discharge)
- MIL STD 883E - Method 3015-6 Class 3

Application

- High Speed MultiMediaCard™

Description

The EMIF06-HMC01F2 is a highly integrated array designed to suppress EMI / RFI noise for High Speed MultiMediaCard™ port filtering. The EMIF06-HMC01F2 Flip-Chip packaging means the package size is equal to the die size. Additionally, this filter includes an ESD protection circuitry which prevents the protected device from destruction when subjected to ESD surges up to 15 kV.

Figure 1. Pin configuration (ball side) and Basic cell configuration

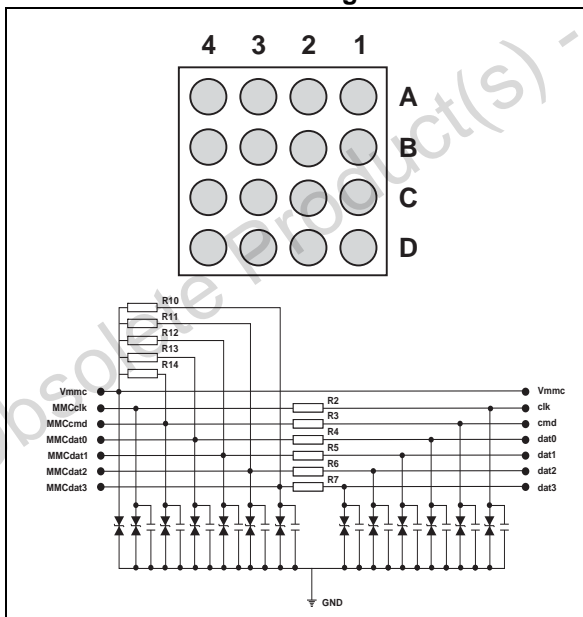

Table 1. Ball configuration

A1	cmd	C1	dat2
A2	clk	C2	gnd
A3	Vmmc/Vdd	C3	MMCdat1
A4	MMCclk	C4	MMCdat0
B1	dat1	D1	dat3
B2	dat0	D2	gnd
B3	gnd	D3	MMCdat3
B4	MMCcmd	D4	MMCdat2

Features

- 6 lines low-pass-filter
- High efficiency in EMI filtering
- Very low PCB space consuming: < 4.4 mm²
- Lead-free package

TM: IPAD is a trademark of STMicroelectronics.

1 Electrical characteristics

Table 2. Absolute maximum ratings ($T_{amb} = 25\text{ }^{\circ}\text{C}$)

Symbol	Parameter and test conditions	Value	Unit
V_{PP}	Internal pins (A4, B4, C3, C4, D3, D4):		
	ESD discharge IEC61000-4-2, air discharge	2	kV
	ESD discharge IEC61000-4-2, contact discharge	2	
	External pins (A1, A2, A3, B1, B2, C1, D1):		
	ESD discharge IEC61000-4-2, air discharge	15	
ESD discharge IEC61000-4-2, contact discharge	8		
T_j	Maximum junction temperature	125	$^{\circ}\text{C}$
T_{op}	Operating temperature range	- 40 to + 85	$^{\circ}\text{C}$
T_{stg}	Storage temperature range	- 55 to + 150	$^{\circ}\text{C}$

Figure 2. Electrical characteristics (definitions)

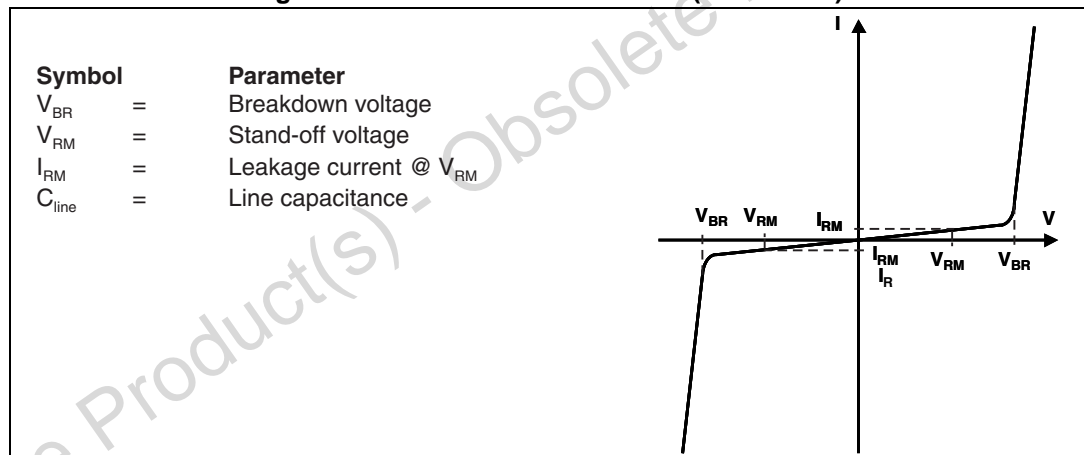

Table 3. Electrical characteristics ($T_{amb} = 25\text{ }^{\circ}\text{C}$)

Symbol	Test conditions	Tolerance	Min.	Typ.	Max.	Unit
V_{BR}	$I_R = 1\text{ mA}$		14			V
I_{RM}	$V_{RM} = 3\text{ V}$				0.1	μA
C_{line}	@ 0 V				20	pF
$R_2, R_3, R_4, R_5, R_6, R_7$	$I = 50\text{ mA}$	$\pm 20\%$		50		Ω
$R_{10}, R_{11}, R_{12}, R_{13}$	$I = 50\text{ }\mu\text{A}$	$\pm 30\%$		75		k Ω
R_{14}	$I = 200\text{ }\mu\text{A}$	$\pm 30\%$		7		k Ω

Figure 3. S21 (dB) attenuation measurement

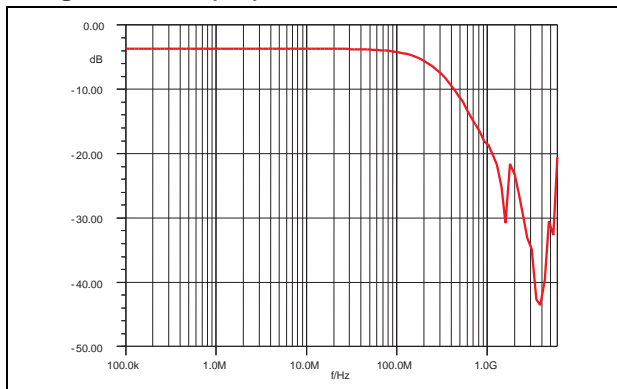

Figure 4. Analog crosstalk measurements

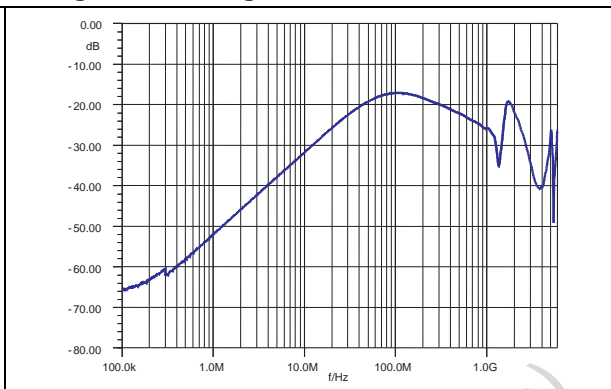

Figure 5. ESD response to IEC61000-4-2 (+15 kV air discharge) on one input V(in) and on one output (Vout)

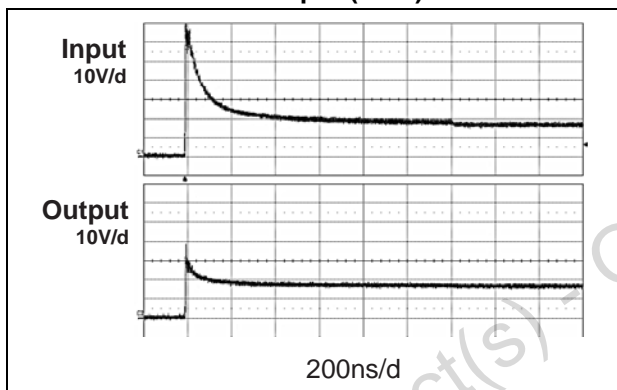

Figure 6. ESD response to IEC61000-4-2 (-15 kV air discharge) on one input V(in) and on one output (Vout)

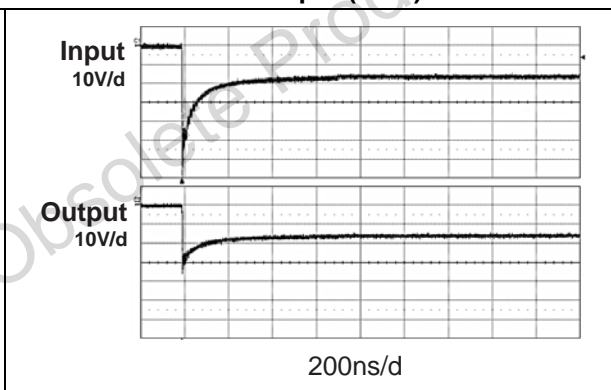
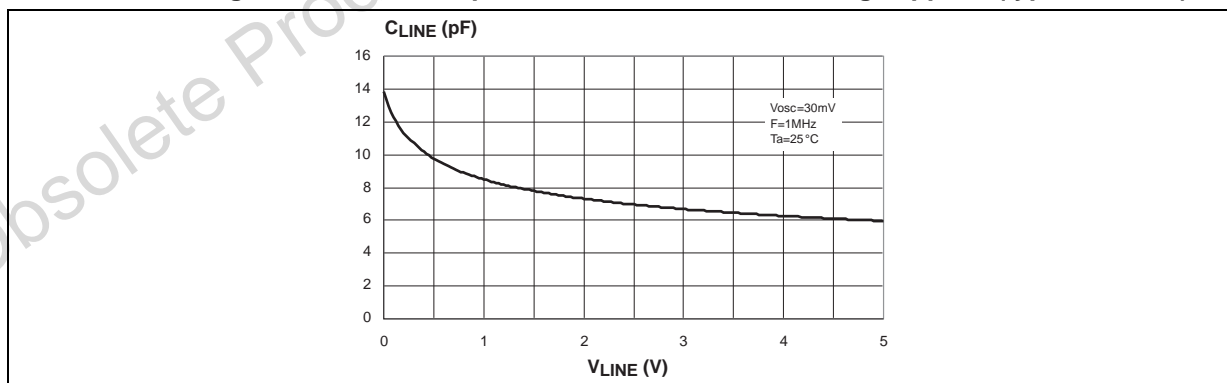

Figure 7. Junction capacitance versus reverse voltage applied (typical values)



2 Aplac model

Figure 8. Aplac model device structure

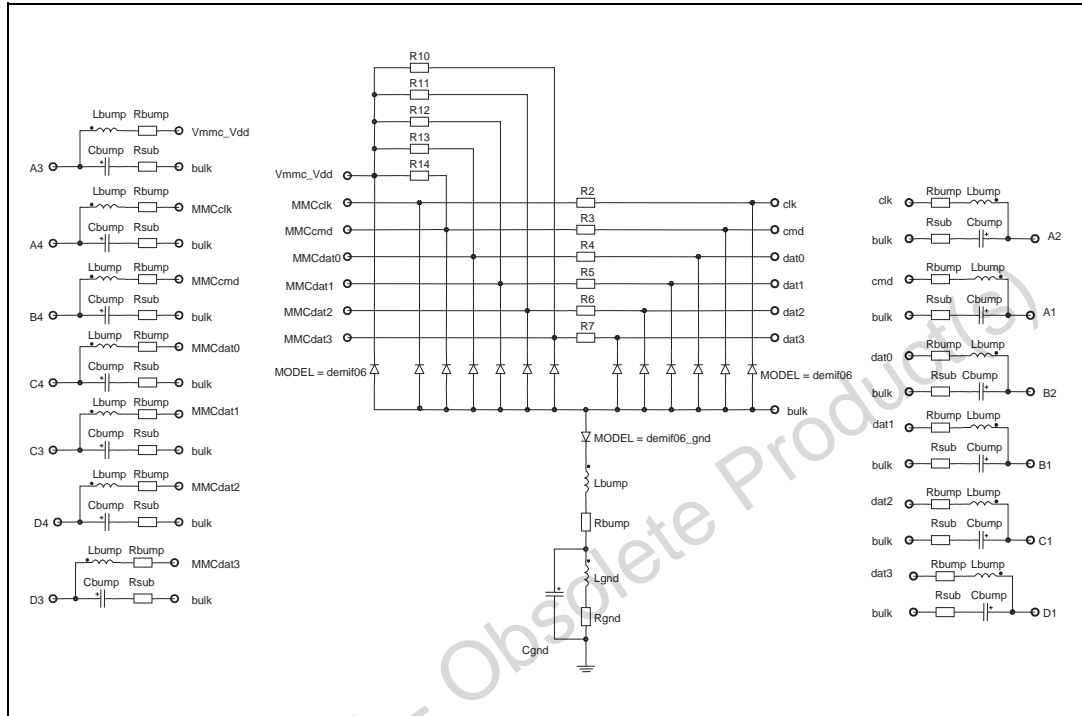
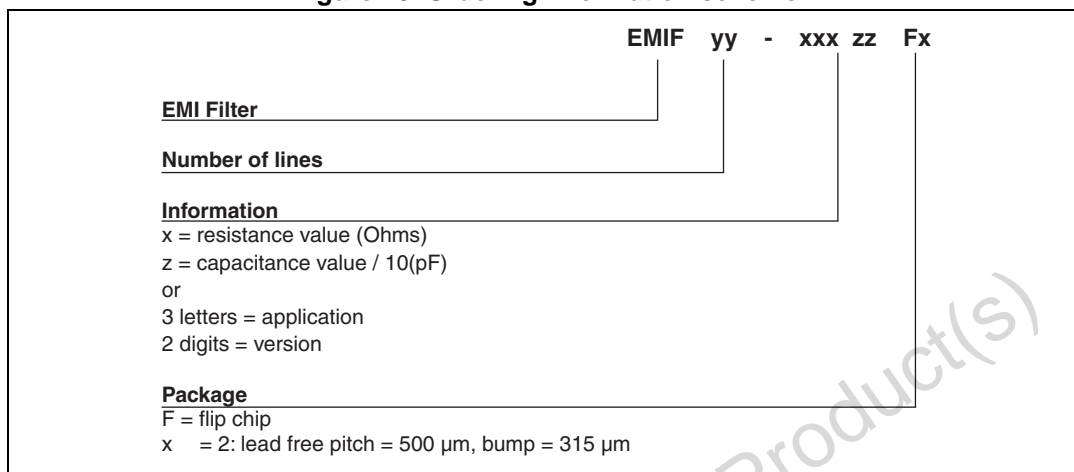

Figure 9. Aplac model parameters

Variables	Variables	demif06_gnd	demif06
R2 50	Cz 11pF	BV=14	BV=14
R3 50	Cz_gnd 45pF	IBV=1m	IBV=1m
R4 50	RS_gnd 480m	CJO=Cz_gnd	CJO=Cz
R5 50	LS 950pH	M=0.31	M=0.31
R6 50	Rs 150m	RS=RS_gnd	RS=1
R7 50	Rbump 100m	VJ=0.6	VJ=0.6
R10 75k	Lbump 50pH	TT=100n	TT=100n
R11 75k	Cbump 0.15pF		
R12 75k	Lgnd 50pH		
R13 75k	Rgnd 100m		
R14 7k	Cgnd 0.15pF		
Rsub 100m			

3 Ordering information scheme

Figure 10. Ordering information scheme



4 Package information

In order to meet environmental requirements, ST offers these devices in different grades of ECOPACK® packages, depending on their level of environmental compliance. ECOPACK® specifications, grade definitions and product status are available at: www.st.com. ECOPACK® is an ST trademark.

Figure 11. Package dimensions

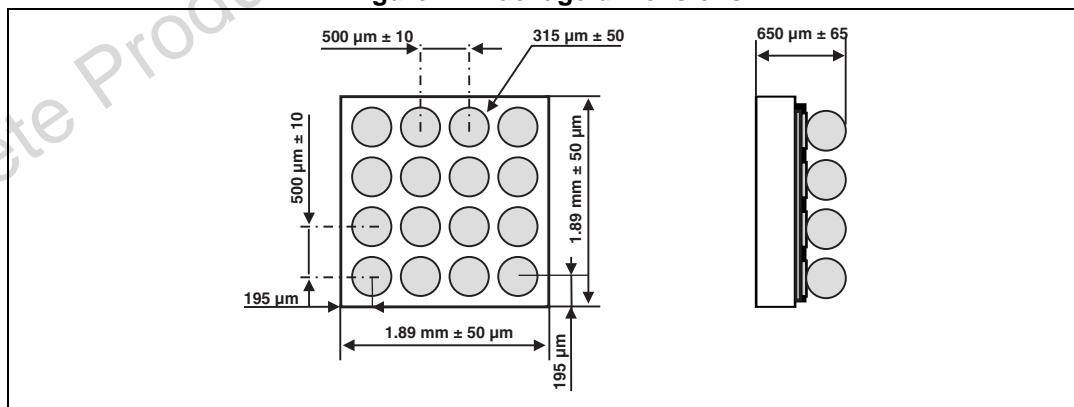

Figure 12. Footprint

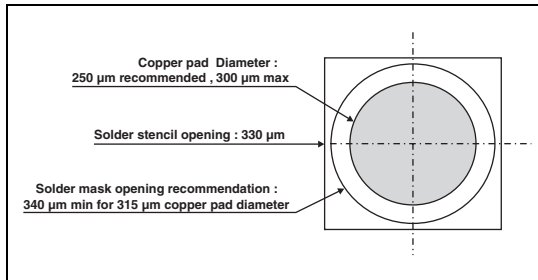

Figure 13. Marking

Dot, ST logo
xx = marking
z = packaging location
yww = datecode
(y = year
ww = week)

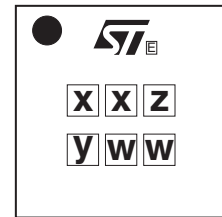
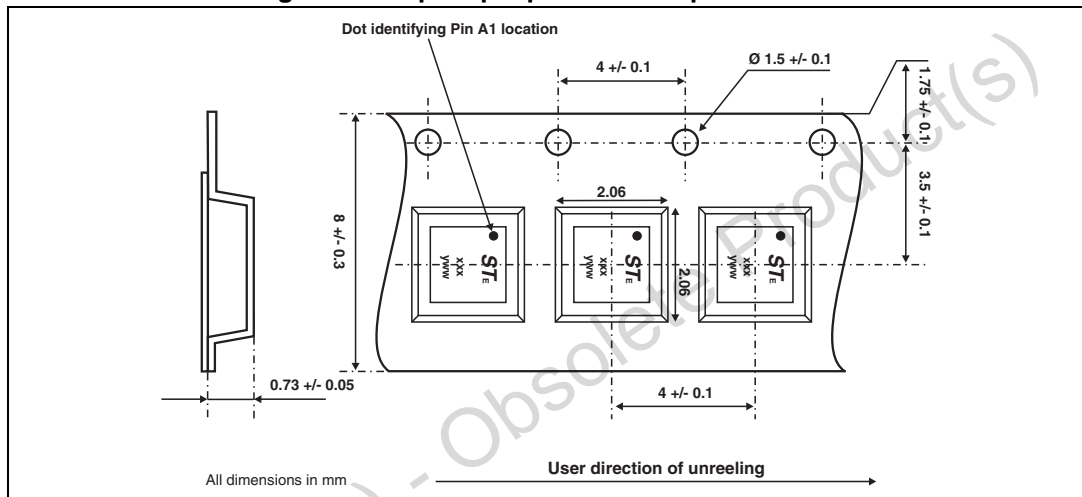

Figure 14. Flip chip tape and reel specification



5 Ordering information

Table 4. Ordering information

Order code	Marking	Package	Weight	Base qty	Delivery mode
EMIF06-HMC01F2	GH	Flip chip	5.3 mg	5000	Tape and reel 7"

Note: More informations are available in the application notes:
AN1235: "Flip chip: Package description and recommendations for use"

6 Revision history

Table 5. Document revision history

Date	Revision	Changes
25-Jan-2005	1	Initial release.
27-Nov-2007	2	Updated ECOPACK statement. Updated Figure 10 , Figure 11 , Figure 12 , Figure 13 and Figure 14 . Reformatted to current standards.
17-Mar-2014	3	Updated die size in Figure 11 .

Please Read Carefully:

Information in this document is provided solely in connection with ST products. STMicroelectronics NV and its subsidiaries ("ST") reserve the right to make changes, corrections, modifications or improvements, to this document, and the products and services described herein at any time, without notice.

All ST products are sold pursuant to ST's terms and conditions of sale.

Purchasers are solely responsible for the choice, selection and use of the ST products and services described herein, and ST assumes no liability whatsoever relating to the choice, selection or use of the ST products and services described herein.

No license, express or implied, by estoppel or otherwise, to any intellectual property rights is granted under this document. If any part of this document refers to any third party products or services it shall not be deemed a license grant by ST for the use of such third party products or services, or any intellectual property contained therein or considered as a warranty covering the use in any manner whatsoever of such third party products or services or any intellectual property contained therein.

UNLESS OTHERWISE SET FORTH IN ST'S TERMS AND CONDITIONS OF SALE ST DISCLAIMS ANY EXPRESS OR IMPLIED WARRANTY WITH RESPECT TO THE USE AND/OR SALE OF ST PRODUCTS INCLUDING WITHOUT LIMITATION IMPLIED WARRANTIES OF MERCHANTABILITY, FITNESS FOR A PARTICULAR PURPOSE (AND THEIR EQUIVALENTS UNDER THE LAWS OF ANY JURISDICTION), OR INFRINGEMENT OF ANY PATENT, COPYRIGHT OR OTHER INTELLECTUAL PROPERTY RIGHT.

ST PRODUCTS ARE NOT DESIGNED OR AUTHORIZED FOR USE IN: (A) SAFETY CRITICAL APPLICATIONS SUCH AS LIFE SUPPORTING, ACTIVE IMPLANTED DEVICES OR SYSTEMS WITH PRODUCT FUNCTIONAL SAFETY REQUIREMENTS; (B) AERONAUTIC APPLICATIONS; (C) AUTOMOTIVE APPLICATIONS OR ENVIRONMENTS, AND/OR (D) AEROSPACE APPLICATIONS OR ENVIRONMENTS. WHERE ST PRODUCTS ARE NOT DESIGNED FOR SUCH USE, THE PURCHASER SHALL USE PRODUCTS AT PURCHASER'S SOLE RISK, EVEN IF ST HAS BEEN INFORMED IN WRITING OF SUCH USAGE, UNLESS A PRODUCT IS EXPRESSLY DESIGNATED BY ST AS BEING INTENDED FOR "AUTOMOTIVE, AUTOMOTIVE SAFETY OR MEDICAL" INDUSTRY DOMAINS ACCORDING TO ST PRODUCT DESIGN SPECIFICATIONS. PRODUCTS FORMALLY ESCC, QML OR JAN QUALIFIED ARE DEEMED SUITABLE FOR USE IN AEROSPACE BY THE CORRESPONDING GOVERNMENTAL AGENCY.

Resale of ST products with provisions different from the statements and/or technical features set forth in this document shall immediately void any warranty granted by ST for the ST product or service described herein and shall not create or extend in any manner whatsoever, any liability of ST.

ST and the ST logo are trademarks or registered trademarks of ST in various countries.

Information in this document supersedes and replaces all information previously supplied.

The ST logo is a registered trademark of STMicroelectronics. All other names are the property of their respective owners.

© 2014 STMicroelectronics - All rights reserved

STMicroelectronics group of companies

Australia - Belgium - Brazil - Canada - China - Czech Republic - Finland - France - Germany - Hong Kong - India - Israel - Italy - Japan - Malaysia - Malta - Morocco - Philippines - Singapore - Spain - Sweden - Switzerland - United Kingdom - United States of America

www.st.com