



Keywords: SNR, Signal to Noise Ratio, Optical Sensor, PPG, Heart Rate, SP02, power consumption

APPLICATION NOTE 6410

SIGNAL-TO-NOISE RATIO AS A QUANTITATIVE MEASURE FOR OPTICAL BIOSENSORS

Abstract: This application note provides an overview of the importance of SNR in evaluating Maxim Integrated advanced sensor products. It also goes into the details of SNR testing, including setup and procedure, as well as the interdependency of SNR and power consumption. Finally, it discusses new ways of evaluating SNR for human PPG signal.

Introduction

When evaluating a Maxim Integrated sensor product, it is extremely important to characterize signal to noise ratio (SNR). In biosensors, such as Maxim’s sensors, lower noise in the signal facilitates faster time to report results. Therefore, a device with higher SNR enhances user experience by shortening time to report human vitals while increasing accuracy of results at the same time.

Like most other electronic devices in the market, Maxim parts can be evaluated by measuring noise under various conditions or configurations and comparing it to the desired signal under the same conditions. That comparison, achieved through SNR, provides the evaluator with a leading indicator of measurement accuracy in the various operating environments and conditions.

SNR: An Effective Approach to Performance Evaluation

Defined as the ratio of signal power and noise power, SNR considers noise from all sources such as electrical, thermal, optical, and even environmental noise.

$$\text{SNR} = \frac{\text{Signal Power}}{\text{Noise Power}}$$

If the impedance for signal and noise is the same, SNR can be calculated using the amplitude of signal and the amplitude of the noise. Therefore, SNR can be expressed as:

$$\text{SNR} = \frac{(\text{Signal Amplitude})^2}{(\text{Noise Amplitude})^2}$$

When expressing SNR in dB, it would then be calculated as:

$$\text{SNR} = 10 \times \log_{10} \left(\frac{\text{Signal Amplitude}}{\text{Noise Amplitude}} \right)^2$$

$$\text{SNR} = 20 \times \log_{10} \left(\frac{\text{Signal Amplitude}}{\text{Noise Amplitude}} \right)$$

For measurements such as optical measurements that have positive values and when the signal is a DC signal, Signal Amplitude can be calculated using the signal average, and Noise Amplitude can be calculated using the standard deviation of the measured signal. For example, consider a signal such as in **Figure 1**.

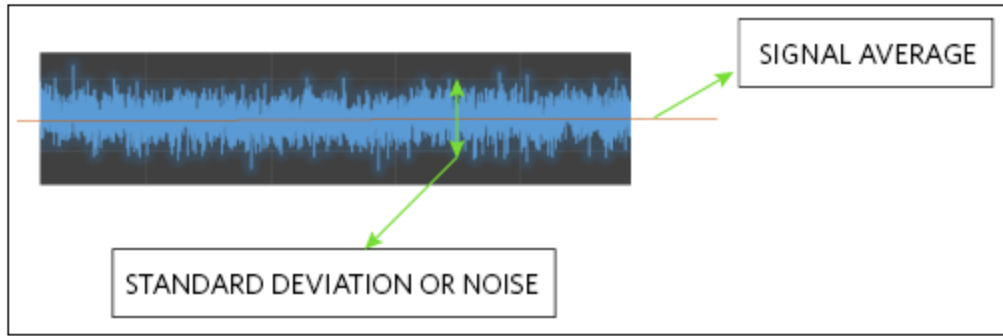

Figure 1. Standard deviation and signal average.

SNR can also be calculated as:

$$\text{SNR} = 20 \times \log_{10} \left(\frac{\text{Signal Average}}{\text{Standard Deviation of Signal}} \right)$$

For Maxim's advanced sensor products, SNR is calculated as the ratio of average ADC counts and standard deviation of ADC counts where ADC counts are linearly dependent on the optical signal received.

SNR Test Setup and Process

The purpose of the SNR test is to determine the extent of noise in the measured signal from the sensor. As signal amplitude varies, there are corresponding changes in the noise that might or might not affect the performance of the sensor. SNR provides an effective way to evaluate performance due to these variations.

Input current, in this example of an optical sensor, is the current generated by the photodiode and is dependent on the light incidence on the surface of that photodiode. Consider a general block diagram for a Maxim sensor (**Figure 2**).

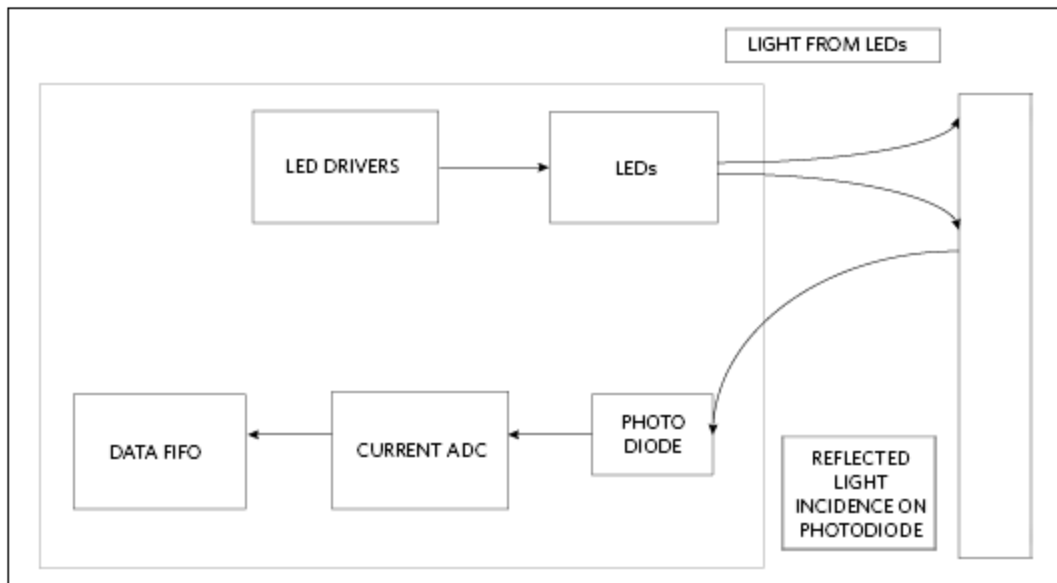

Figure 2. Optical sensor block diagram.

For the same LED, the photonic energy at the photodiode would increase as the LED drive current, pulse width, and sample rate increases, but the reflected light incidence on photodiode, which generates the photodiode current, and hence the signal of interest, is dependent on various other factors including LED-light output, the reflected photonic energy, and the responsivity of photodiode for the specific test setup under consideration. Therefore, LED current is not used as a measure of signal amplitude when evaluating the SNR; instead, the resulting photodiode current is used as the parameter to characterize SNR.

Conventional setups for SNR tests involve placing the test setup with the device to be characterized on a stable surface such as an optical bench that is free of any environmental vibrations. The test setup is placed under a white reflector such that the light from the LEDs is reflected by said reflector on to the photodiode. Generally, a white styrene high-impact plastic card is used as a reflector. Other materials can also be used.

The setup is to be covered with a black box or a black sheet to block ambient light. Even though ambient light is mostly cancelled in this DUT, variations due to different light conditions might skew the results which poses a problem when it comes to characterization and correlation. Therefore, covering the test setup to block ambient light ensures that the results do not vary on different test floors or with different ambient conditions. See **Figure 3** and **Figure 4**.

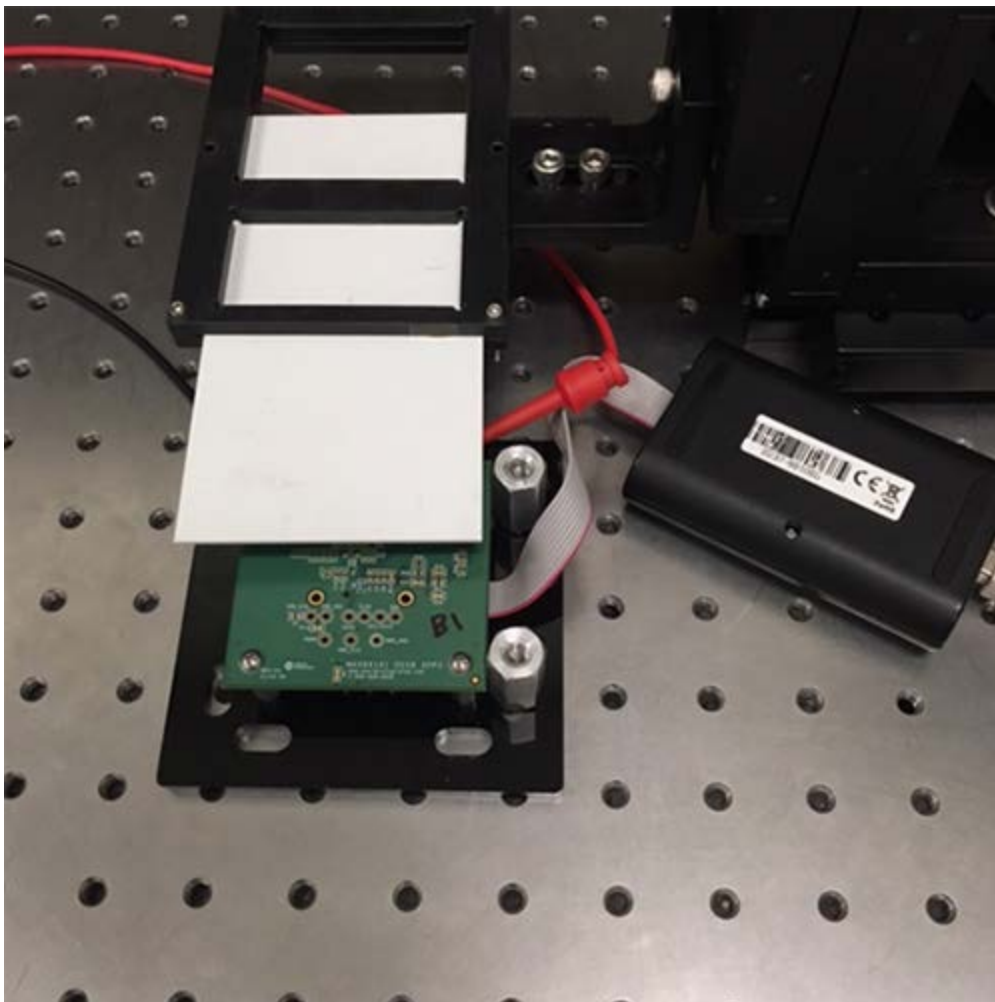

Figure 3. Reflector card on stable optical bench with top secured to avoid vibration.

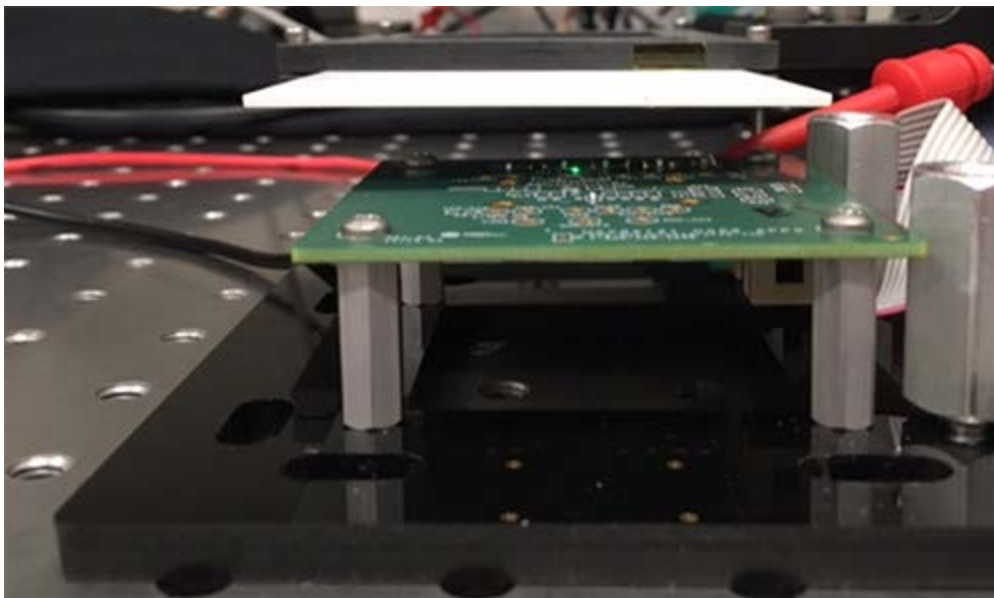

Figure 4. Side view of test setup with tightly controlled air gap between DUT and reflective white card.

It is also important to consider the stability of the test setup. The light incidence on the photodiode changes when there is variation in the distance between reflector and photodiode. If a reflector is unstable, it results in distance variations possibly during sample acquisition. This leads to a variation in light incidence on the photodiode, which in turn results in variations in ADC counts and that would translate into noise on the signal, but in fact it is an artifact of an unstable test setup.

Once the test setup is ready and stable, data can be acquired for various configurations. Each set of data is then analyzed for the SNR either through a script (MATLAB® or Python) or by an evaluator. LED current as well as reflector position, and therefore distance between reflector and part, is changed to get to a certain level of ADC counts or input current of the ADC. The input current is varied over the allowable device limits. Input current can be calculated from ADC counts using the equation:

$$\text{Input current} = \frac{\text{ADC counts}}{\text{Full scale counts}} \times \text{ADC gain range}$$

For example, with a 19-bit ADC with its input range set to 16 μ A, a data set shows average counts of around 330,000 counts. The input current is calculated as:

$$\text{Input current} = \frac{330000}{2^{19}} \times 16$$

$$\text{Input current} = 10.07\mu\text{A}$$

A sweep of input current and calculation of SNR using a data set for each setting of input current results in a plot of SNR vs. input current like the one shown in **Figure 5**.

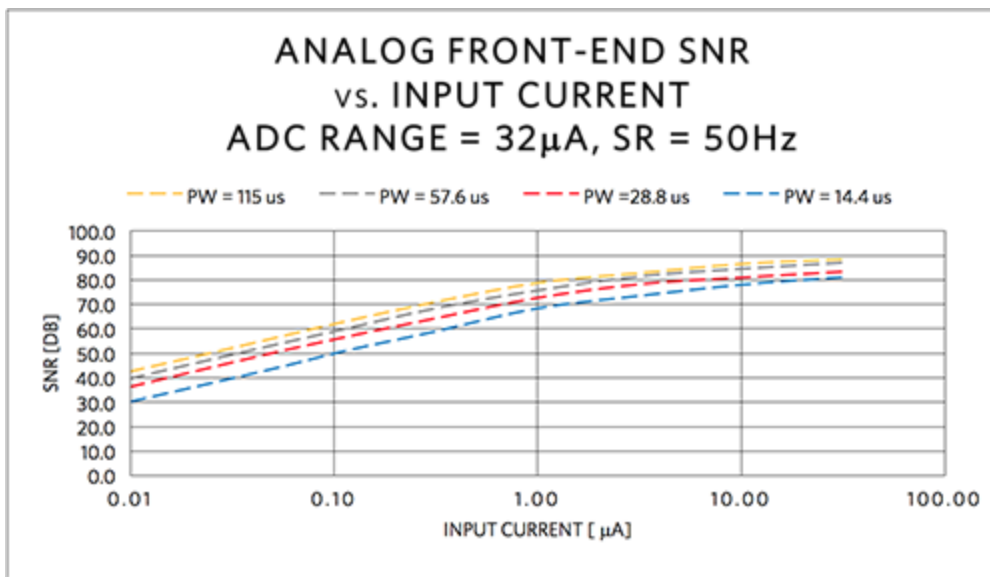

Figure 5. SNR as a function of photo-detector input current.

Challenge (SNR vs. Power)

The above plot might give an impression that using one of Maxim's sensor devices with input current close to the maximum limit should be the best configuration since it provides highest SNR, and, therefore, the best performance. But taking other factors into account makes it evident that the highest input current (or highest SNR) is not necessarily the most optimal solution.

The ADC input current primarily depends on two factors:

1. **LED light output.** With higher LED light output, the light getting reflected back to PD is higher as well.
2. **Distance from reflector.** For the same LED light output, the input current increases when the distance from reflector decreases.

In an actual application of a biosensor, the distance from skin is assumed to be constant whether it is on the wrist, finger, or any other site. The only variable left in that case is the LED light output. For simplification, we assume that the LED light output increases linearly with LED average current. It, therefore, becomes clear that for a specific part and application, SNR improves with a higher LED average current. Average LED current is determined by the LED drive current (LED current while LED driver is on), pulse width, and sample rate. Higher average current not only translates into higher SNR, but also leads to higher system power consumption. For example, **Figure 6** shows power consumption for one of Maxim's biosensors, the [MAX86140](#).

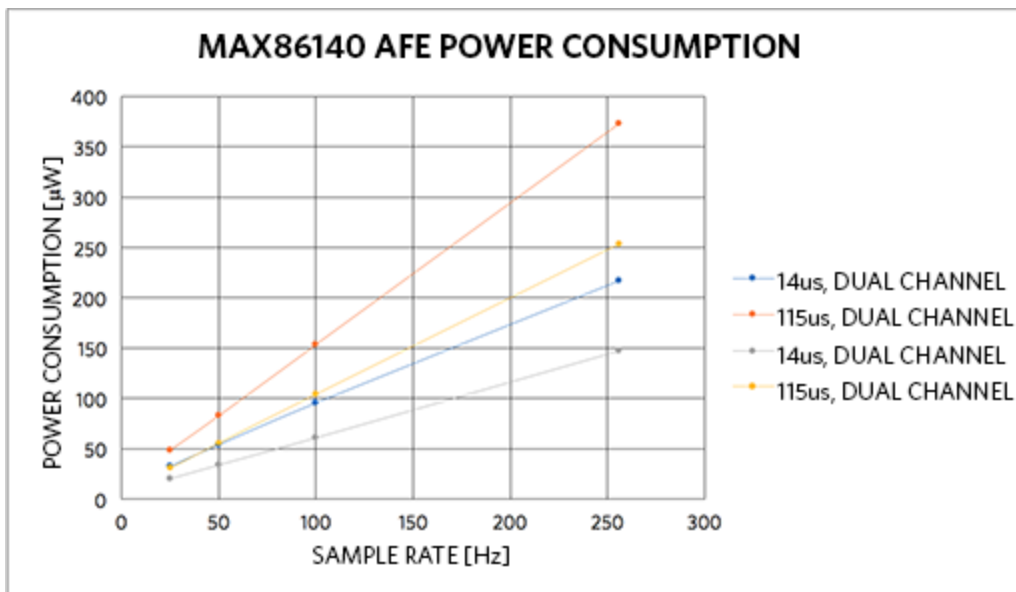

Figure 6. Power as a function of sample rate and pulse width.

Therefore, it is important to define the most optimal solution to get the best SNR and power consumption for each system. This is becoming more and more critical because of the increasing expectations on low-power systems such as wearables and accessories with an ever-increasing demand for long battery life. Thus, cranking up LED current or increasing duty cycle to obtain a high average current and a high SNR is not always the best solution.

The ideal solution should be based on each application and system requirements. But an informed decision must be made after careful evaluation of both SNR and power consumption for the configuration options being considered.

New Avenues: SNR for Human Subject Testing

The conventional approach for calculating SNR fails when it comes to SNR evaluation for human test data. Maxim biosensors are designed to accurately measure human vitals such as heart rate, and blood oxygenation using photoplethysmography (PPG) data. A PPG signal shows the variations in blood volume at a specific site (finger, wrist, ear, etc.) and is then used to calculate various human vitals through algorithms. **Figure 7** shows a typical PPG signal.

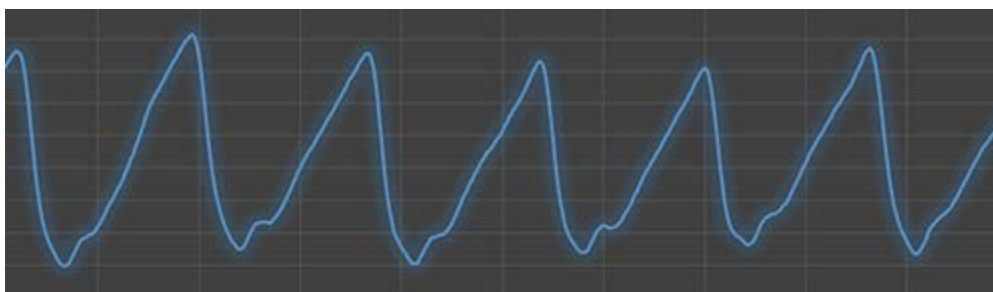

Figure 7. A typical PPG signal.

Since average ADC counts and standard deviation is used for estimating signal amplitude and noise amplitude respectively, it only works with DC signals. With a signal such as PPG, which is a combination of AC and DC, this approach gives false noise results. Maxim's engineers are proposing a completely new approach when it comes to evaluating SNR for human PPG data achieved through filtering in frequency domain.

Human PPG data needed for algorithm processing is generally below 20Hz. Data from human subjects can be filtered to separate noise above 20Hz and signal below 20Hz. This approach effectively separates noise amplitude and signal amplitude from a signal that is AC + DC. See **Figure 8**.

This is an exciting new approach enabling applications engineers and system engineers to evaluate SNR for human PPG data and leads to a more meaningful analysis of product performance in various systems and applications.

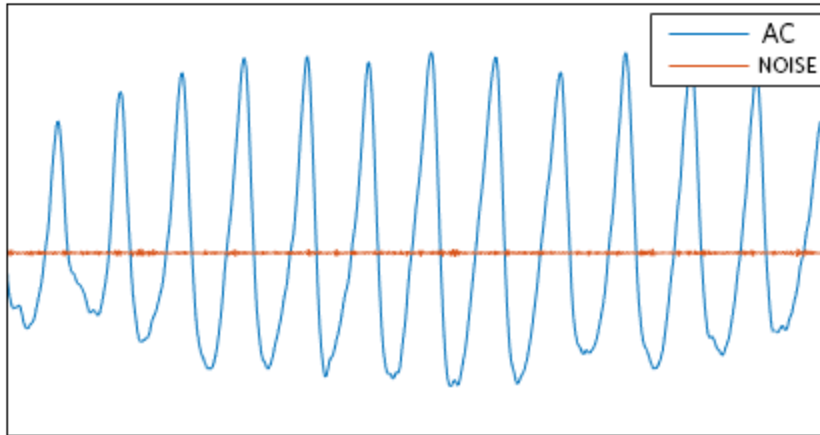

Figure 8. Noise separated from AC signal after filtering.

Conclusion

In the electronics industry, more specifically when it comes to sensor products, SNR is one of the first and most important specification that shows the superiority of a part over another. Signal-to-noise ratio along with a handful of other specs gives an evaluator a clear snapshot of the device performance. This calls for developing an in-depth and strong understanding of the SNR test setup, procedures, and the approach for SNR calculation. This application note attempts to provide knowledge and a complete understanding that leads to better evaluation and customer support.

MATLAB is a registered trademark of *The MathWorks Inc.*

Related Parts		
MAX30101	High-Sensitivity Pulse Oximeter and Heart-Rate Sensor for Wearable Health	Free Samples
MAX30102	High-Sensitivity Pulse Oximeter and Heart-Rate Sensor for Wearable Health	Free Samples
MAX86140	Best-in-Class Optical Pulse Oximeter and Heart-Rate Sensor for Wearable Health	Free Samples

More Information

For Technical Support: <https://www.maximintegrated.com/en/support>

For Samples: <https://www.maximintegrated.com/en/samples>

Other Questions and Comments: <https://www.maximintegrated.com/en/contact>

Application Note 6410: <https://www.maximintegrated.com/en/an6410>

APPLICATION NOTE 6410, AN6410, AN 6410, APP6410, Appnote6410, Appnote 6410

© 2014 Maxim Integrated Products, Inc.

The content on this webpage is protected by copyright laws of the United States and of foreign

countries. For requests to copy this content, [contact us](#).
Additional Legal Notices: <https://www.maximintegrated.com/en/legal>