

74HC1G32-Q100; 74HCT1G32-Q100

2-input OR gate

Rev. 1 — 8 August 2012

Product data sheet

1. General description

74HC1G32-Q100 and 74HCT1G32-Q100 are high-speed Si-gate CMOS devices. They provide a 2-input OR function.

The standard output currents are half of those of the 74HC32-Q100 and 74HCT32-Q100.

This product has been qualified to the Automotive Electronics Council (AEC) standard Q100 (Grade 1) and is suitable for use in automotive applications.

2. Features and benefits

- Automotive product qualification in accordance with AEC-Q100 (Grade 1)
 - ◆ Specified from -40 °C to $+85\text{ °C}$ and from -40 °C to $+125\text{ °C}$
- Input levels:
 - ◆ For 74HC1G32-Q100: CMOS level
 - ◆ For 74HCT1G32-Q100: TTL level
- Symmetrical output impedance
- High noise immunity
- Low power dissipation
- Balanced propagation delays
- ESD protection:
 - ◆ MIL-STD-883, method 3015 exceeds 2000 V
 - ◆ HBM JESD22-A114F exceeds 2000 V
 - ◆ MM JESD22-A115-A exceeds 200 V ($C = 200\text{ pF}$, $R = 0\ \Omega$)
- SOT353-1 and SOT753 package options

3. Ordering information

Table 1. Ordering information

Type number	Package			Version
	Temperature range	Name	Description	
74HC1G32GW-Q100	-40 °C to $+125\text{ °C}$	TSSOP5	plastic thin shrink small outline package; 5 leads; body width 1.25 mm	SOT353-1
74HCT1G32GW-Q100				
74HC1G32GV-Q100	-40 °C to $+125\text{ °C}$	SC-74A	plastic surface-mounted package; 5 leads	SOT753
74HCT1G32GV-Q100				

4. Marking

Table 2. Marking codes

Type number	Marking code ^[1]
74HC1G32GW-Q100	HG
74HCT1G32GW-Q100	TG
74HC1G32GV-Q100	H32
74HCT1G32GV-Q100	T32

[1] The pin 1 indicator is located on the lower left corner of the device, below the marking code.

5. Functional diagram

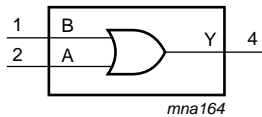

Fig 1. Logic symbol

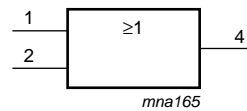

Fig 2. IEC logic symbol

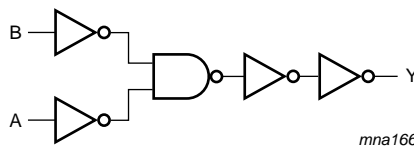

Fig 3. Logic diagram

6. Pinning information

6.1 Pinning

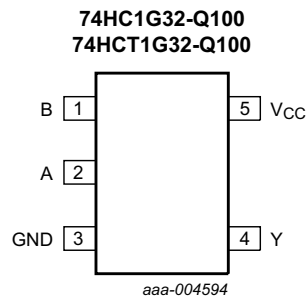

Fig 4. Pin configuration

6.2 Pin description

Table 3. Pin description

Symbol	Pin	Description
B	1	data input B
A	2	data input A
GND	3	ground (0 V)
Y	4	data output Y
V _{CC}	5	supply voltage

7. Functional description

Table 4. Function table

H = HIGH voltage level; L = LOW voltage level

Inputs		Output
A	B	Y
L	L	L
L	H	H
H	L	H
H	H	H

8. Limiting values

Table 5. Limiting values

In accordance with the Absolute Maximum Rating System (IEC 60134). Voltages are referenced to GND (ground = 0 V). [\[1\]](#)

Symbol	Parameter	Conditions	Min	Max	Unit
V _{CC}	supply voltage		-0.5	+7.0	V
I _{IK}	input clamping current	V _I < -0.5 V or V _I > V _{CC} + 0.5 V	-	±20	mA
I _{OK}	output clamping current	V _O < -0.5 V or V _O > V _{CC} + 0.5 V	-	±20	mA
I _O	output current	-0.5 V < V _O < V _{CC} + 0.5 V	-	±12.5	mA
I _{CC}	supply current		-	25	mA
I _{GND}	ground current		-25	-	mA
T _{stg}	storage temperature		-65	+150	°C
P _{tot}	total power dissipation	T _{amb} = -40 °C to +125 °C	[2] -	200	mW

[1] The input and output voltage ratings may be exceeded if the input and output current ratings are observed.

[2] Above 55 °C the value of P_{tot} derates linearly with 2.5 mW/K.

9. Recommended operating conditions

Table 6. Recommended operating conditions

Voltages are referenced to GND (ground = 0 V).

Symbol	Parameter	Conditions	74HC1G32-Q100			74HCT1G32-Q100			Unit
			Min	Typ	Max	Min	Typ	Max	
V _{CC}	supply voltage		2.0	5.0	6.0	4.5	5.0	5.5	V
V _I	input voltage		0	-	V _{CC}	0	-	V _{CC}	V
V _O	output voltage		0	-	V _{CC}	0	-	V _{CC}	V
T _{amb}	ambient temperature		-40	+25	+125	-40	+25	+125	°C
Δt/ΔV	input transition rise and fall rate	V _{CC} = 2.0 V	-	-	625	-	-	-	ns/V
		V _{CC} = 4.5 V	-	-	139	-	-	139	ns/V
		V _{CC} = 6.0 V	-	-	83	-	-	-	ns/V

10. Static characteristics

Table 7. Static characteristics

Voltages are referenced to GND (ground = 0 V). All typical values are measured at T_{amb} = 25 °C.

Symbol	Parameter	Conditions	-40 °C to +85 °C			-40 °C to +125 °C		Unit
			Min	Typ	Max	Min	Max	
74HC1G32-Q100								
V _{IH}	HIGH-level input voltage	V _{CC} = 2.0 V	1.5	1.2	-	1.5	-	V
		V _{CC} = 4.5 V	3.15	2.4	-	3.15	-	V
		V _{CC} = 6.0 V	4.2	3.2	-	4.2	-	V
V _{IL}	LOW-level input voltage	V _{CC} = 2.0 V	-	0.8	0.5	-	0.5	V
		V _{CC} = 4.5 V	-	2.1	1.35	-	1.35	V
		V _{CC} = 6.0 V	-	2.8	1.8	-	1.8	V
V _{OH}	HIGH-level output voltage	V _I = V _{IH} or V _{IL}						
		I _O = -20 μA; V _{CC} = 2.0 V	1.9	2.0	-	1.9	-	V
		I _O = -20 μA; V _{CC} = 4.5 V	4.4	4.5	-	4.4	-	V
		I _O = -20 μA; V _{CC} = 6.0 V	5.9	6.0	-	5.9	-	V
		I _O = -2.0 mA; V _{CC} = 4.5 V	4.13	4.32	-	3.7	-	V
V _{OL}	LOW-level output voltage	V _I = V _{IH} or V _{IL}						
		I _O = 20 μA; V _{CC} = 2.0 V	-	0	0.1	-	0.1	V
		I _O = 20 μA; V _{CC} = 4.5 V	-	0	0.1	-	0.1	V
		I _O = 20 μA; V _{CC} = 6.0 V	-	0	0.1	-	0.1	V
		I _O = 2.0 mA; V _{CC} = 4.5 V	-	0.15	0.33	-	0.4	V
		I _O = 2.6 mA; V _{CC} = 6.0 V	-	0.16	0.33	-	0.4	V
I _I	input leakage current	V _I = V _{CC} or GND; V _{CC} = 6.0 V	-	-	1.0	-	1.0	μA
I _{CC}	supply current	V _I = V _{CC} or GND; I _O = 0 A; V _{CC} = 6.0 V	-	-	10	-	20	μA
C _I	input capacitance		-	1.5	-	-	-	pF

Table 7. Static characteristics ...continued

Voltages are referenced to GND (ground = 0 V). All typical values are measured at $T_{amb} = 25\text{ °C}$.

Symbol	Parameter	Conditions	–40 °C to +85 °C			–40 °C to +125 °C		Unit
			Min	Typ	Max	Min	Max	
74HCT1G32-Q100								
V_{IH}	HIGH-level input voltage	$V_{CC} = 4.5\text{ V to }5.5\text{ V}$	2.0	1.6	-	2.0	-	V
V_{IL}	LOW-level input voltage	$V_{CC} = 4.5\text{ V to }5.5\text{ V}$	-	1.2	0.8	-	0.8	V
V_{OH}	HIGH-level output voltage	$V_I = V_{IH}$ or V_{IL} ; $V_{CC} = 4.5\text{ V}$						
		$I_O = -20\text{ }\mu\text{A}$	4.4	4.5	-	4.4	-	V
		$I_O = -2.0\text{ mA}$	4.13	4.32	-	3.7	-	V
V_{OL}	LOW-level output voltage	$V_I = V_{IH}$ or V_{IL} ; $V_{CC} = 4.5\text{ V}$						
		$I_O = 20\text{ }\mu\text{A}$	-	0	0.1	-	0.1	V
		$I_O = 2.0\text{ mA}$	-	0.15	0.33	-	0.4	V
I_I	input leakage current	$V_I = V_{CC}$ or GND; $V_{CC} = 5.5\text{ V}$	-	-	1.0	-	1.0	μA
I_{CC}	supply current	$V_I = V_{CC}$ or GND; $I_O = 0\text{ A}$; $V_{CC} = 5.5\text{ V}$	-	-	10	-	20	μA
ΔI_{CC}	additional supply current	per input; $V_{CC} = 4.5\text{ V to }5.5\text{ V}$; $V_I = V_{CC} - 2.1\text{ V}$; $I_O = 0\text{ A}$	-	-	500	-	850	μA
C_I	input capacitance		-	1.5	-	-	-	pF

11. Dynamic characteristics

Table 8. Dynamic characteristics

$GND = 0\text{ V}$; $t_r = t_f \leq 6.0\text{ ns}$. All typical values are measured at $T_{amb} = 25\text{ °C}$. For test circuit see [Figure 6](#)

Symbol	Parameter	Conditions	–40 °C to +85 °C			–40 °C to +125 °C		Unit
			Min	Typ	Max	Min	Max	
74HC1G32-Q100								
t_{pd}	propagation delay	A and B to Y; see Figure 5						
		$V_{CC} = 2.0\text{ V}$; $C_L = 50\text{ pF}$	-	18	115	-	135	ns
		$V_{CC} = 4.5\text{ V}$; $C_L = 50\text{ pF}$	-	8	23	-	27	ns
		$V_{CC} = 5.0\text{ V}$; $C_L = 15\text{ pF}$	-	8	-	-	-	ns
		$V_{CC} = 6.0\text{ V}$; $C_L = 50\text{ pF}$	-	7	20	-	23	ns
C_{PD}	power dissipation capacitance	$V_I = GND$ to V_{CC}	-	19	-	-	-	pF

Table 8. Dynamic characteristics ...continued

$GND = 0\text{ V}$; $t_r = t_f \leq 6.0\text{ ns}$. All typical values are measured at $T_{amb} = 25\text{ }^\circ\text{C}$. For test circuit see [Figure 6](#)

Symbol	Parameter	Conditions	-40 °C to +85 °C			-40 °C to +125 °C		Unit
			Min	Typ	Max	Min	Max	
74HCT1G32-Q100								
t_{pd}	propagation delay	A and B to Y; see Figure 5	[1]					
		$V_{CC} = 4.5\text{ V}$; $C_L = 50\text{ pF}$	-	10	24	-	27	ns
		$V_{CC} = 5.0\text{ V}$; $C_L = 15\text{ pF}$	-	10	-	-	-	ns
C_{PD}	power dissipation capacitance	$V_I = GND\text{ to }V_{CC} - 1.5\text{ V}$	[2]					
			-	20	-	-	-	pF

[1] t_{pd} is the same as t_{PLH} and t_{PHL} .

[2] C_{PD} is used to determine the dynamic power dissipation P_D (μW).

$$P_D = C_{PD} \times V_{CC}^2 \times f_i + \sum (C_L \times V_{CC}^2 \times f_o) \text{ where:}$$

f_i = input frequency in MHz

f_o = output frequency in MHz

C_L = output load capacitance in pF

V_{CC} = supply voltage in V

$\sum (C_L \times V_{CC}^2 \times f_o)$ = sum of outputs

12. Waveforms

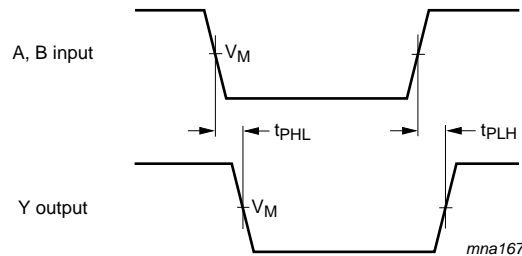

For 74HC1G32-Q100: $V_M = 0.5 \times V_{CC}$; $V_I = GND\text{ to }V_{CC}$

For 74HCT1G32-Q100: $V_M = 1.3\text{ V}$; $V_I = GND\text{ to }3.0\text{ V}$

Fig 5. The input (A and B) to output (Y) propagation delays

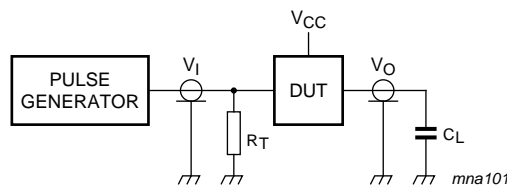

Measurement points are given in [Table 8](#). Definitions for test circuit:

C_L = Load capacitance including jig and probe capacitance.

R_T = Termination resistance should be equal to output impedance Z_o of the pulse generator.

Fig 6. Load circuitry for switching times

13. Package outline

TSSOP5: plastic thin shrink small outline package; 5 leads; body width 1.25 mm

SOT353-1

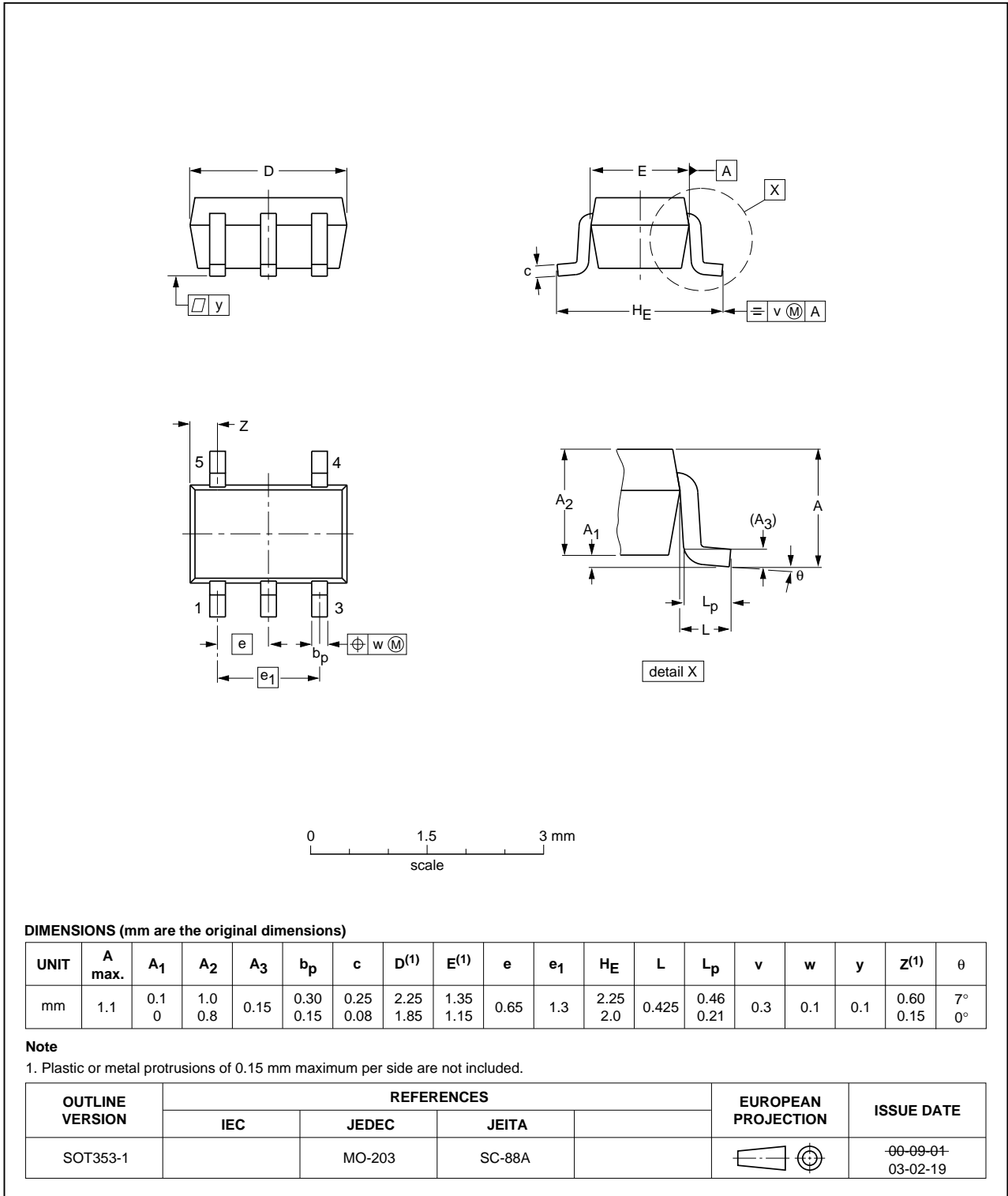

Fig 7. Package outline SOT353-1 (TSSOP5)

Plastic surface-mounted package; 5 leads

SOT753

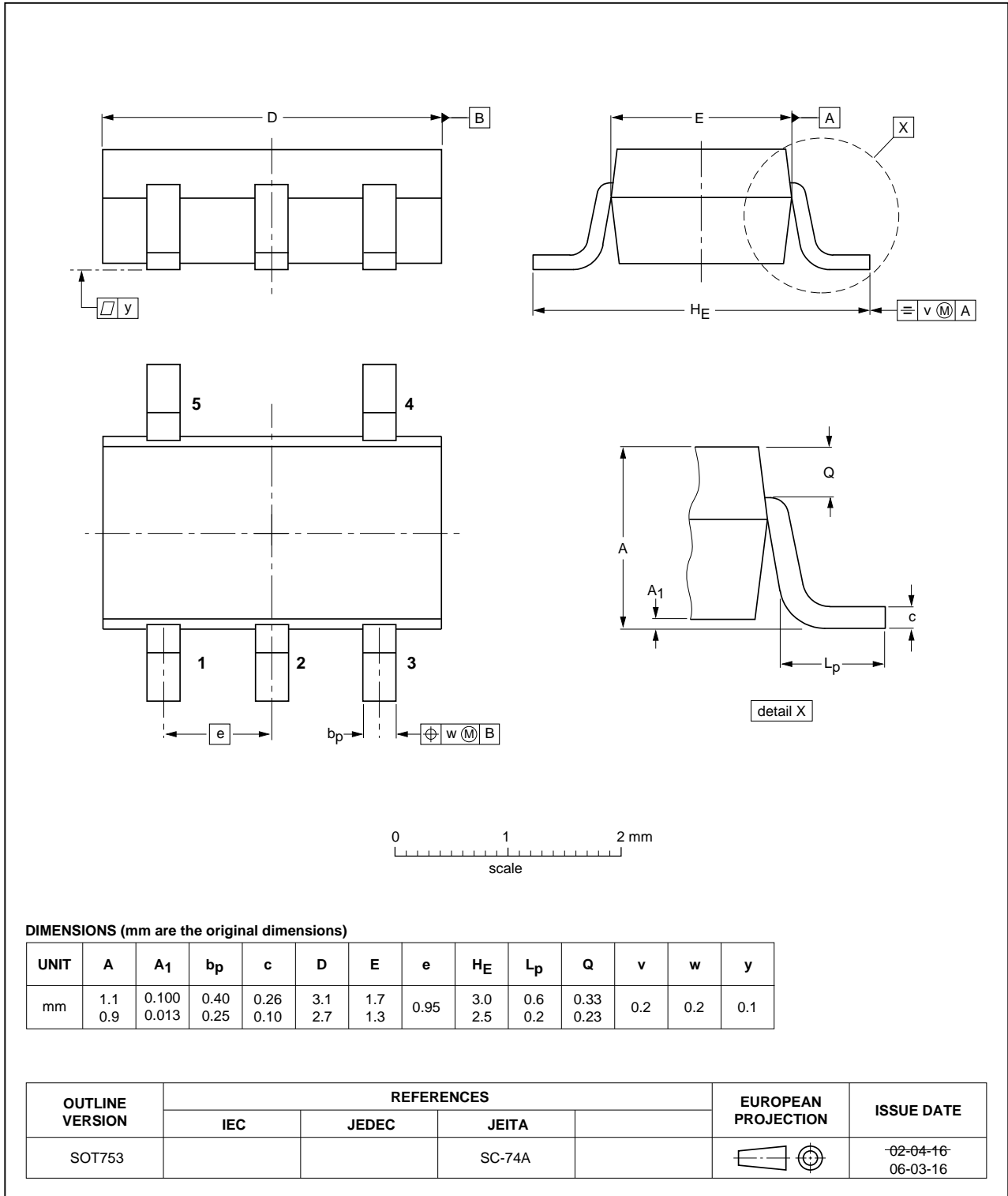

Fig 8. Package outline SOT753 (SC-74A)

14. Abbreviations

Table 9. Abbreviations

Acronym	Description
CMOS	Complementary Metal Oxide Semiconductor
TTL	Transistor-Transistor Logic
HBM	Human Body Model
ESD	ElectroStatic Discharge
MM	Machine Model
DUT	Device Under Test
MIL	Military

15. Revision history

Table 10. Revision history

Document ID	Release date	Data sheet status	Change notice	Supersedes
74HC_HCT1G32_Q100 v.1	20120808	Product data sheet	-	-

16. Legal information

16.1 Data sheet status

Document status ^{[1][2]}	Product status ^[3]	Definition
Objective [short] data sheet	Development	This document contains data from the objective specification for product development.
Preliminary [short] data sheet	Qualification	This document contains data from the preliminary specification.
Product [short] data sheet	Production	This document contains the product specification.

[1] Please consult the most recently issued document before initiating or completing a design.

[2] The term 'short data sheet' is explained in section "Definitions".

[3] The product status of device(s) described in this document may have changed since this document was published and may differ in case of multiple devices. The latest product status information is available on the Internet at URL <http://www.nexperia.com>.

16.2 Definitions

Draft — The document is a draft version only. The content is still under internal review and subject to formal approval, which may result in modifications or additions. Nexperia does not give any representations or warranties as to the accuracy or completeness of information included herein and shall have no liability for the consequences of use of such information.

Short data sheet — A short data sheet is an extract from a full data sheet with the same product type number(s) and title. A short data sheet is intended for quick reference only and should not be relied upon to contain detailed and full information. For detailed and full information see the relevant full data sheet, which is available on request via the local Nexperia sales office. In case of any inconsistency or conflict with the short data sheet, the full data sheet shall prevail.

Product specification — The information and data provided in a Product data sheet shall define the specification of the product as agreed between Nexperia and its customer, unless Nexperia and customer have explicitly agreed otherwise in writing. In no event however, shall an agreement be valid in which the Nexperia product is deemed to offer functions and qualities beyond those described in the Product data sheet.

16.3 Disclaimers

Limited warranty and liability — Information in this document is believed to be accurate and reliable. However, Nexperia does not give any representations or warranties, expressed or implied, as to the accuracy or completeness of such information and shall have no liability for the consequences of use of such information. Nexperia takes no responsibility for the content in this document if provided by an information source outside of Nexperia.

In no event shall Nexperia be liable for any indirect, incidental, punitive, special or consequential damages (including - without limitation - lost profits, lost savings, business interruption, costs related to the removal or replacement of any products or rework charges) whether or not such damages are based on tort (including negligence), warranty, breach of contract or any other legal theory.

Notwithstanding any damages that customer might incur for any reason whatsoever, Nexperia's aggregate and cumulative liability towards customer for the products described herein shall be limited in accordance with the *Terms and conditions of commercial sale* of Nexperia.

Right to make changes — Nexperia reserves the right to make changes to information published in this document, including without limitation specifications and product descriptions, at any time and without notice. This document supersedes and replaces all information supplied prior to the publication hereof.

Suitability for use in automotive applications — This Nexperia product has been qualified for use in automotive applications. Unless otherwise agreed in writing, the product is not designed, authorized or warranted to be suitable for use in life support, life-critical or safety-critical systems or equipment, nor in applications where failure or malfunction of a Nexperia product can reasonably be expected to result in personal injury, death or severe property or environmental damage. Nexperia and its suppliers accept no liability for inclusion and/or use of Nexperia products in such equipment or applications and therefore such inclusion and/or use is at the customer's own risk.

Applications — Applications that are described herein for any of these products are for illustrative purposes only. Nexperia makes no representation or warranty that such applications will be suitable for the specified use without further testing or modification.

Customers are responsible for the design and operation of their applications and products using Nexperia products, and Nexperia accepts no liability for any assistance with applications or customer product design. It is customer's sole responsibility to determine whether the Nexperia product is suitable and fit for the customer's applications and products planned, as well as for the planned application and use of customer's third party customer(s). Customers should provide appropriate design and operating safeguards to minimize the risks associated with their applications and products.

Nexperia does not accept any liability related to any default, damage, costs or problem which is based on any weakness or default in the customer's applications or products, or the application or use by customer's third party customer(s). Customer is responsible for doing all necessary testing for the customer's applications and products using Nexperia products in order to avoid a default of the applications and the products or of the application or use by customer's third party customer(s). Nexperia does not accept any liability in this respect.

Limiting values — Stress above one or more limiting values (as defined in the Absolute Maximum Ratings System of IEC 60134) will cause permanent damage to the device. Limiting values are stress ratings only and (proper) operation of the device at these or any other conditions above those given in the Recommended operating conditions section (if present) or the Characteristics sections of this document is not warranted. Constant or repeated exposure to limiting values will permanently and irreversibly affect the quality and reliability of the device.

Terms and conditions of commercial sale — Nexperia products are sold subject to the general terms and conditions of commercial sale, as published at <http://www.nexperia.com/profile/terms>, unless otherwise agreed in a valid written individual agreement. In case an individual agreement is concluded only the terms and conditions of the respective agreement shall apply. Nexperia hereby expressly objects to applying the customer's general terms and conditions with regard to the purchase of Nexperia products by customer.

No offer to sell or license — Nothing in this document may be interpreted or construed as an offer to sell products that is open for acceptance or the grant, conveyance or implication of any license under any copyrights, patents or other industrial or intellectual property rights.

Export control — This document as well as the item(s) described herein may be subject to export control regulations. Export might require a prior authorization from competent authorities.

Translations — A non-English (translated) version of a document is for reference only. The English version shall prevail in case of any discrepancy between the translated and English versions.

16.4 Trademarks

Notice: All referenced brands, product names, service names and trademarks are the property of their respective owners.

17. Contact information

For more information, please visit: <http://www.nexperia.com>

For sales office addresses, please send an email to: salesaddresses@nexperia.com

18. Contents

1	General description	1
2	Features and benefits	1
3	Ordering information	1
4	Marking	2
5	Functional diagram	2
6	Pinning information	2
6.1	Pinning	2
6.2	Pin description	3
7	Functional description	3
8	Limiting values	3
9	Recommended operating conditions	4
10	Static characteristics	4
11	Dynamic characteristics	5
12	Waveforms	6
13	Package outline	7
14	Abbreviations	9
15	Revision history	9
16	Legal information	10
16.1	Data sheet status	10
16.2	Definitions	10
16.3	Disclaimers	10
16.4	Trademarks	11
17	Contact information	11
18	Contents	12